



# **L1 Pro8 & L1 Pro16**

Portable Line Array System

Owner's Guide





Please read and keep all safety, security, and use instructions.

Important Safety Instructions

**CE** Bose Corporation hereby declares that this product is in compliance with the essential requirements and other relevant provisions of Directive 2014/53/EU and all other applicable EU directive requirements. The complete declaration of conformity can be found at: [www.Bose.com/compliance](http://www.Bose.com/compliance).

1. Read these instructions.
2. Keep these instructions.
3. Heed all warnings.
4. Follow all instructions.
5. Do not use this apparatus near water.
6. Clean only with a dry cloth.
7. Do not block any ventilation openings. Install in accordance with the manufacturer's instructions.
8. Do not install near any heat sources such as radiators, heat registers, stoves, or other apparatus (including amplifiers) that produce heat.
9. Do not defeat the safety purpose of the polarized or grounding-type plug. A polarized plug has two blades with one wider than the other. A grounding type plug has two blades and a third grounding prong. The wide blade or the third prong are provided for your safety. If the provided plug does not fit into your outlet, consult an electrician for replacement of the obsolete outlet.
10. Protect the power cord from being walked on or pinched, particularly at plugs, convenience receptacles, and the point where it exits from the apparatus.
11. Only use attachments/accessories specified by the manufacturer.
12.  Use only with the cart, stand, tripod, bracket, or table specified by the manufacturer or sold with the apparatus. When a cart is used, use caution when moving the cart/apparatus combination to avoid injury from tip-over.
13. Unplug this apparatus during lightning storms or when unused for long periods of time.
14. Refer all servicing to qualified personnel. Servicing is required when the apparatus has been damaged in any way such as power-supply cord or plug is damaged, liquid has been spilled or objects have fallen into the apparatus, the apparatus has been exposed to rain or moisture, does not operate normally, or has been dropped.

WARNINGS/CAUTIONS

-  This symbol on the product means there is uninsulated, dangerous voltage within the product enclosure that may present a risk of electrical shock.
-  This symbol on the product means there are important operating and maintenance instructions in this guide.
-  Contains small parts which may be a choking hazard. Not suitable for children under age 3.
-  This product contains magnetic material. Consult your physician on whether this might affect your implantable medical device.
-  Use at altitude less than 2000 meters only.

- Do NOT make unauthorized alterations to this product.
- Do NOT use in vehicles or boats.
- Do NOT place the product in a confined space such as in a wall cavity or in an enclosed cabinet while in use.
- Do NOT place or install the bracket or product near any heat sources, such as fireplaces, radiators, heat registers or other apparatus (including amplifiers) that produce heat.
- Keep the product away from fire and heat sources. Do NOT place naked flame sources, such as lighted candles, on or near the product.
- To reduce the risk of fire or electrical shock, do NOT expose the product to rain, liquids, or moisture.
- Do NOT expose this product to dripping or splashing and do not place objects filled with liquids, such as vases, on or near the product.
- Do NOT use a power inverter with this product.
- Provide an earth connection or ensure the socket outlet incorporates a protective earthing connection before connecting the plug to the mains socket outlet.
- Where the mains plug or an appliance coupler is used as the disconnect device, the disconnect device shall remain readily operable.

Regulatory Information

The product, in accordance with the Ecodesign Requirements for Energy Related Products Directive 2009/125/EC, is in compliance with the following norm(s) or document(s): Regulation (EC) No. 1275/2008, as amended by Regulation (EU) No. 801/2013.

Required Power State Information	Power Modes	
	Standby	Networked Standby
Power consumption in specified power mode, at 230V/50Hz input	≤ 0.5 W	N/A*
Time after which equipment is automatically switched into mode	4 hours	N/A*
Power consumption in networked standby if all wired network ports are connected and all wireless network ports are activated, at 230V/50Hz input	N/A*	
Network port deactivation/activation procedures. Deactivating all networks will enable standby mode.	*Product does not utilize a networked standby mode for a Bluetooth® connection and does not have the ability to be configured to a network via Wi-Fi® or Ethernet	

	L1 Pro8	L1 Pro16
<b>Dimensions</b> (H × W × D)	200.5 × 31.8 × 44 cm (78.9 × 12.5 × 17.3 in)	201.2 × 35.5 × 45.6 cm (79.2 × 14.0 × 18.0 in)
<b>Net Weight</b>	17.3 kg (38.2 lb)	22.9 kg (50.6 lb)
<b>Input Rating</b>	100–240 VAC, 1 A, 50/60 Hz	100–240 VAC, 3 A, 50/60 Hz
<b>Initial turn on inrush current</b>	15.8 A at 120 V; 30.1 A at 230 V	15.7 A at 120 V; 28.4 A at 230 V
<b>Inrush current after AC mains interruption of 5 s</b>	1.2 A at 120 V; 19.4 A at 230 V	2.4 A at 120 V; 8.1 A at 230 V

This equipment should be installed and operated with a minimum distance of 20 cm between radiator and your body.

The product label is located on the bottom of the product.

Model: L1 Pro8/L1 Pro16. The CMIIT ID is located on the bottom of the product.

CAN ICES-3 (B)/NMB-3(B)

Information About Products That Generate Electrical Noise (FCC Compliance Notice for US)

NOTE: This equipment has been tested and found to comply with the limits for a Class B digital device, pursuant to Part 15 of the FCC Rules. These limits are designed to provide reasonable protection against harmful interference in a residential installation. This equipment generates, uses, and can radiate radio frequency energy and, if not installed and used in accordance with the instructions, may cause harmful interference to radio communications. However, there is no guarantee that interference will not occur in a particular installation. If this equipment does cause harmful interference to radio or television reception, which can be determined by turning the equipment off and on, the user is encouraged to try to correct the interference by one or more of the following measures:

- Reorient or relocate the receiving antenna.
- Increase the separation between the equipment and receiver.
- Connect the equipment into an outlet on a circuit different from that to which the receiver is connected.
- Consult the dealer or an experienced radio/TV technician for help.

Changes or modifications not expressly approved by Bose Corporation could void the user's authority to operate this equipment.

This device complies with part 15 of the FCC Rules and with ISED Canada's license-exempt RSS standard(s). Operation is subject to the following two conditions: (1) This device may not cause harmful interference, and (2) this device must accept any interference received, including interference that may cause undesired operation.

For Europe:

Frequency band of operation 2400 to 2483.5 MHz.

Maximum transmit power less than 20 dBm EIRP.

Maximum transmit power is below regulatory limits such that SAR testing is not necessary and exempt per applicable regulations.



This symbol means the product must not be discarded as household waste, and should be delivered to an appropriate collection facility for recycling. Proper disposal and recycling helps protect natural resources, human health, and the environment. For more information on disposal and recycling of this product, contact your local municipality, disposal service, or the shop where you bought this product.

**Management Regulation for Low-power Radio-frequency Devices**

Article XII

According to "Management Regulation for Low-power Radio-frequency Devices", without permission by the NCC, any company, enterprise, or user is not allowed to change frequency, enhance transmitting power, or alter original characteristics, as well as performance, to an approved low power radio-frequency device.

Article XIV

The low power radio-frequency devices shall not influence aircraft security and interfere with legal communications; if found, the user shall cease operating immediately until no interference is achieved. The said legal communications means radio communications in compliance with the Telecommunications Act.

The low power radio-frequency devices must be susceptible with the interference from legal communications or ISM radio wave radiated devices.

**China Restriction of Hazardous Substances Table**

Names and Contents of Toxic or Hazardous Substances or Elements						
Toxic or Hazardous Substances and Elements						
Part Name	Lead (Pb)	Mercury (Hg)	Cadmium (Cd)	Hexavalent (CR(VI))	Polybrominated Biphenyl (PBB)	Polybrominated diphenylether (PBDE)
PCBs	X	0	0	0	0	0
Metal Parts	X	0	0	0	0	0
Plastic Parts	0	0	0	0	0	0
Speakers	X	0	0	0	0	0
Cables	X	0	0	0	0	0

This table is prepared in accordance with the provisions of SJ/T 11364.  
 0: Indicates that this toxic or hazardous substance contained in all of the homogeneous materials for this part is below the limit requirement of GB/T 26572.  
 X: Indicates that this toxic or hazardous substance contained in at least one of the homogeneous materials used for this part is above the limit requirement of GB/T 26572.

**Taiwan Restriction of Hazardous Substances Table**

**Equipment name:** L1 Pro8/L1 Pro16 **Type designation:** 431389L8 / 431389L16

Restricted substances and its chemical symbols						
Unit	Lead (Pb)	Mercury (Hg)	Cadmium (Cd)	Hexavalent chromium (Cr+6)	Polybrominated biphenyls (PBB)	Polybrominated diphenyl ethers (PBDE)
PCBs	-	o	o	o	o	o
Metal Parts	-	o	o	o	o	o
Plastic Parts	o	o	o	o	o	o
Speakers	-	o	o	o	o	o
Cables	-	o	o	o	o	o

**Note 1:** "o" indicates that the percentage content of the restricted substance does not exceed the percentage of reference value of presence.  
**Note 2:** The "-" indicates that the restricted substance corresponds to the exemption.



**Date of Manufacture:** The eighth digit in the serial number indicates the year of manufacture; "0" is 2010 or 2020.

**China Importer:** Bose Electronics (Shanghai) Company Limited, Part C, Plant 9, No. 353 North Riyang Road, China (Shanghai) Pilot Free Trade Zone

**EU Importer:** Bose Products B.V., Gorslaan 60, 1441 RG Purmerend, The Netherlands

**Mexico Importer:** Bose de México, S. de R.L. de C.V., Paseo de las Palmas 405-204, Lomas de Chapultepec, 11000 México, D.F. For service or importer information, call +5255 (5202) 3545

**Taiwan Importer:** Bose Taiwan Branch, 9F-A1, No. 10, Section 3, Minsheng East Road, Taipei City 104, Taiwan. Phone Number: +886-2-2514 7676

**Bose Corporation Headquarters:** 1-877-230-5639

Apple and the Apple logo are trademarks of Apple Inc. registered in the U.S. and other countries. App Store is a service mark of Apple Inc.

The Bluetooth® word mark and logos are registered trademarks owned by Bluetooth SIG, Inc. and any use of such marks by Bose Corporation is under license.

Google Play is a trademark of Google LLC.

Wi-Fi is a registered trademark of Wi-Fi Alliance®

Bose, L1, and ToneMatch are trademarks of Bose Corporation.

All other trademarks are the property of their respective owners.

The Bose Privacy Policy is available on the Bose website.

©2020 Bose Corporation. No part of this work may be reproduced, modified, distributed or otherwise used without prior written permission.

**Please complete and retain for your records.**

The serial and model numbers are located on the product label on the bottom of the product.

Serial number: \_\_\_\_\_

Model number: \_\_\_\_\_

**Warranty Information**

This product is covered by a limited warranty.  
 For warranty details, visit [global.bose.com/warranty](http://global.bose.com/warranty).

<b>Overview</b>	<b>5</b>
Package Contents .....	5
Optional Accessories .....	5
<b>System Setup</b>	<b>6</b>
Connections and Controls .....	6
Assembling the System .....	7
Connecting Power.....	8
AutoOff/Low-power Standby .....	8
Connecting Sources .....	8
Channel 1 & 2 Controls .....	8
Channel 3 Controls.....	9
L1 Mix App Control .....	9
Additional Adjustments .....	10
Channel Mute .....	10
Phantom Power .....	10
System EQ .....	10
System Setup Scenarios .....	11
Solo Musician .....	11
Musician with Mobile Device .....	12
Band .....	12
Musician with T8S Mixer.....	13
Musician Stereo with T4S Mixer.....	13
DJ Stereo .....	14
DJ with Sub1.....	14
Musician Dual Mono.....	15
Musician with S1 Pro Monitor .....	15
<b>Care &amp; Maintenance</b>	<b>16</b>
Cleaning Your L1 Pro .....	16
Troubleshooting .....	16

# Overview

## Package Contents

L1 Pro8

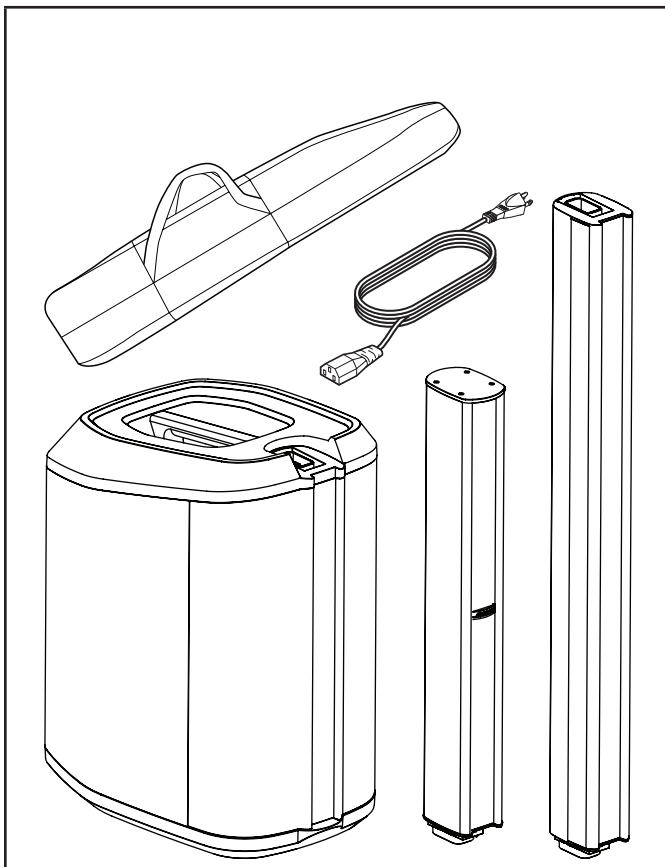

L1 Pro16

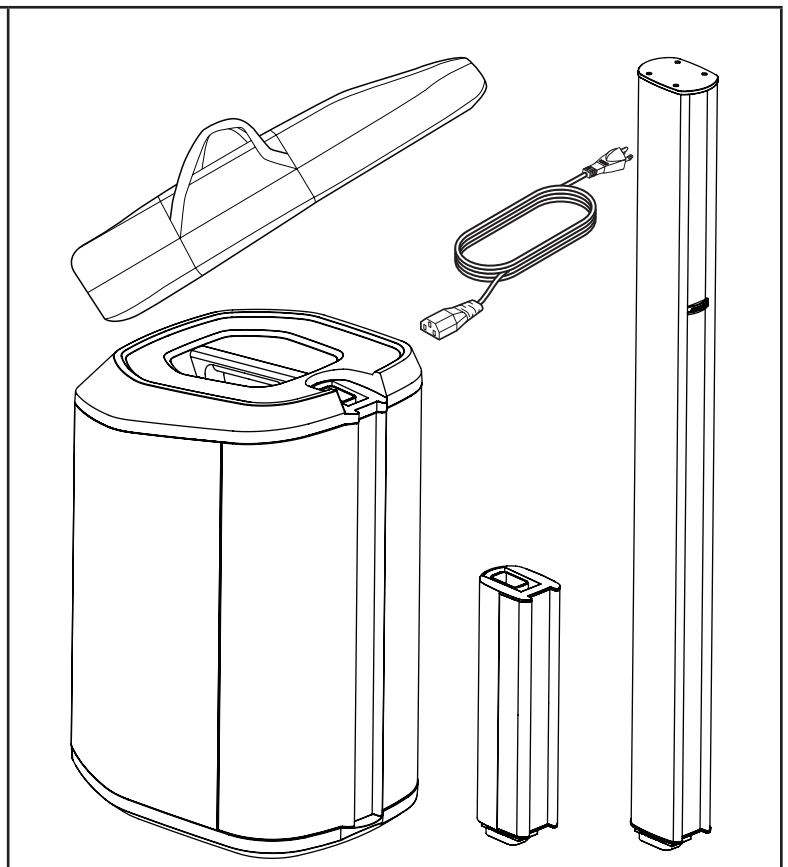

## Optional Accessories

- L1 Pro8 System Bag
- L1 Pro16 System Roller Bag
- L1 Pro8/Pro16 Slip cover

For additional information on L1 Pro accessories, visit [PRO.BOSE.COM](http://PRO.BOSE.COM).

# System Setup

## Connections and Controls

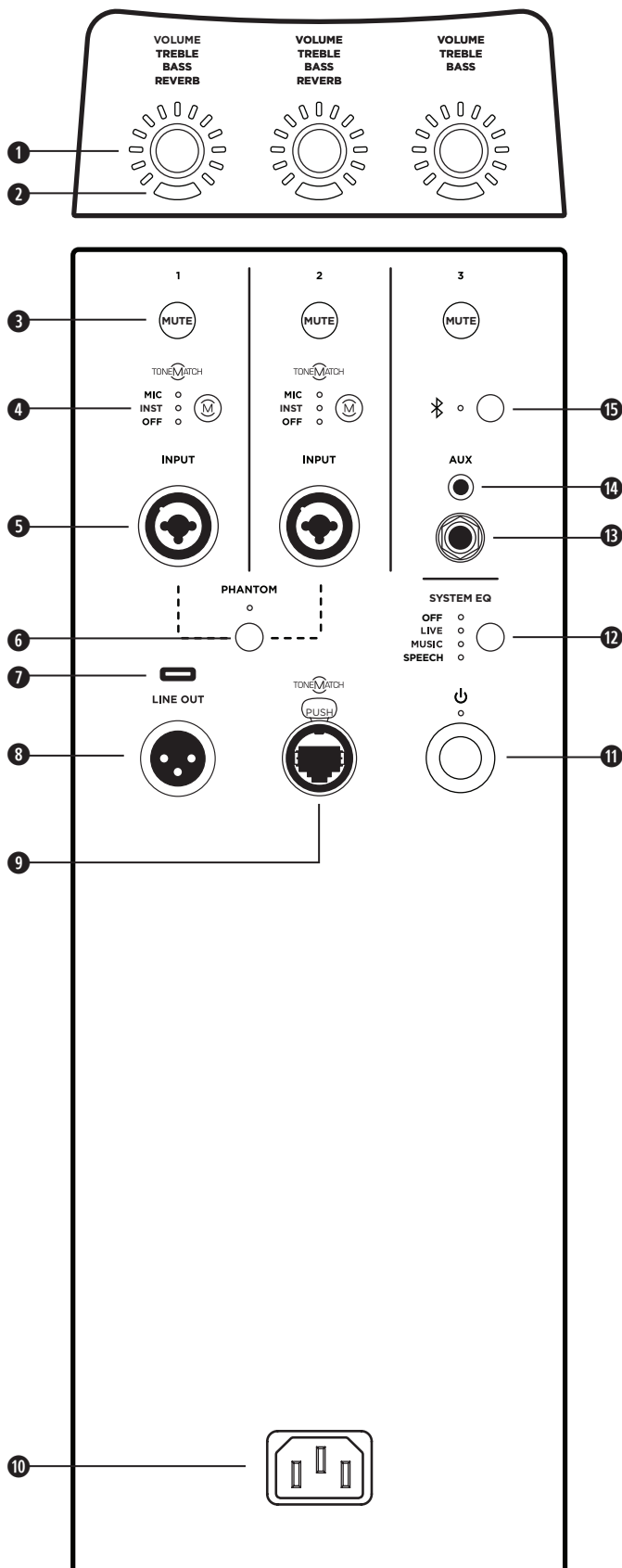

- ➊ **Channel Parameter Control:** Adjust the level of volume, treble, bass, or reverb for your desired channel. Press the control to switch between parameters; rotate the control to adjust the level of your selected parameter.
  - ➋ **Signal/Clip Indicator:** The LED will illuminate green when a signal is present and will illuminate red when the signal is clipping or the system is entering limiting. Reduce the channel or signal volume to prevent signal clipping or limiting.
  - ➌ **Channel Mute:** Mute the output of an individual channel. Press the button to mute the channel. While muted, the button will illuminate white.
  - ➍ **Channel ToneMatch Button:** Select the ToneMatch preset for an individual channel. Use **MIC** for microphones and use **INST** for acoustic guitar. The corresponding LED will illuminate white while selected.
  - ➎ **Channel Input:** Analog input for connecting microphone (XLR), instrument (TS unbalanced), or line level (TRS balanced) cables.
  - ➏ **Phantom Power:** Press the button to apply 48-volt power to channels 1 and 2. The LED will illuminate white while phantom power is applied.
  - ➐ **USB Port:** USB-C connector for Bose service use. **Note:** This port is not compatible with Thunderbolt 3 cables.
  - ➑ **XLR Line Output:** Use an XLR cable to connect the line-level output to a Sub1/Sub2 or another bass module.
  - ➒ **ToneMatch Port:** Connect your L1 Pro to a T4S or T8S ToneMatch mixer via a ToneMatch cable.
- CAUTION:** Do not connect to a computer or phone network.
- ➓ **Power Input:** IEC power cord connection.
  - ➑ **Standby Button:** Press the button to power on the L1 Pro. The LED will illuminate white while the system is on.
  - ➒ **System EQ:** Press the button to scroll through and select a master EQ suitable for the use case. The corresponding LED will illuminate white while selected.
  - ➓ **TRS Line Input:** Use a 6.4-millimeter (¼-inch) TRS cable to connect line-level audio sources.
  - ➓ **Aux Line Input:** Use a 3.5-millimeter (⅛-inch) TRS cable to connect line-level audio sources.
  - ➓ **Bluetooth® Pair Button:** Set up pairing with Bluetooth capable devices. The LED will flash blue while the L1 Pro is discoverable and illuminate solid white when a device is paired for streaming.

## Assembling the System

Before connecting the system to a power source, assemble the system using the array extension and mid-high array.

1. Insert the array extension into the subwoofer power stand.
2. Insert the mid-high array into the array extension.

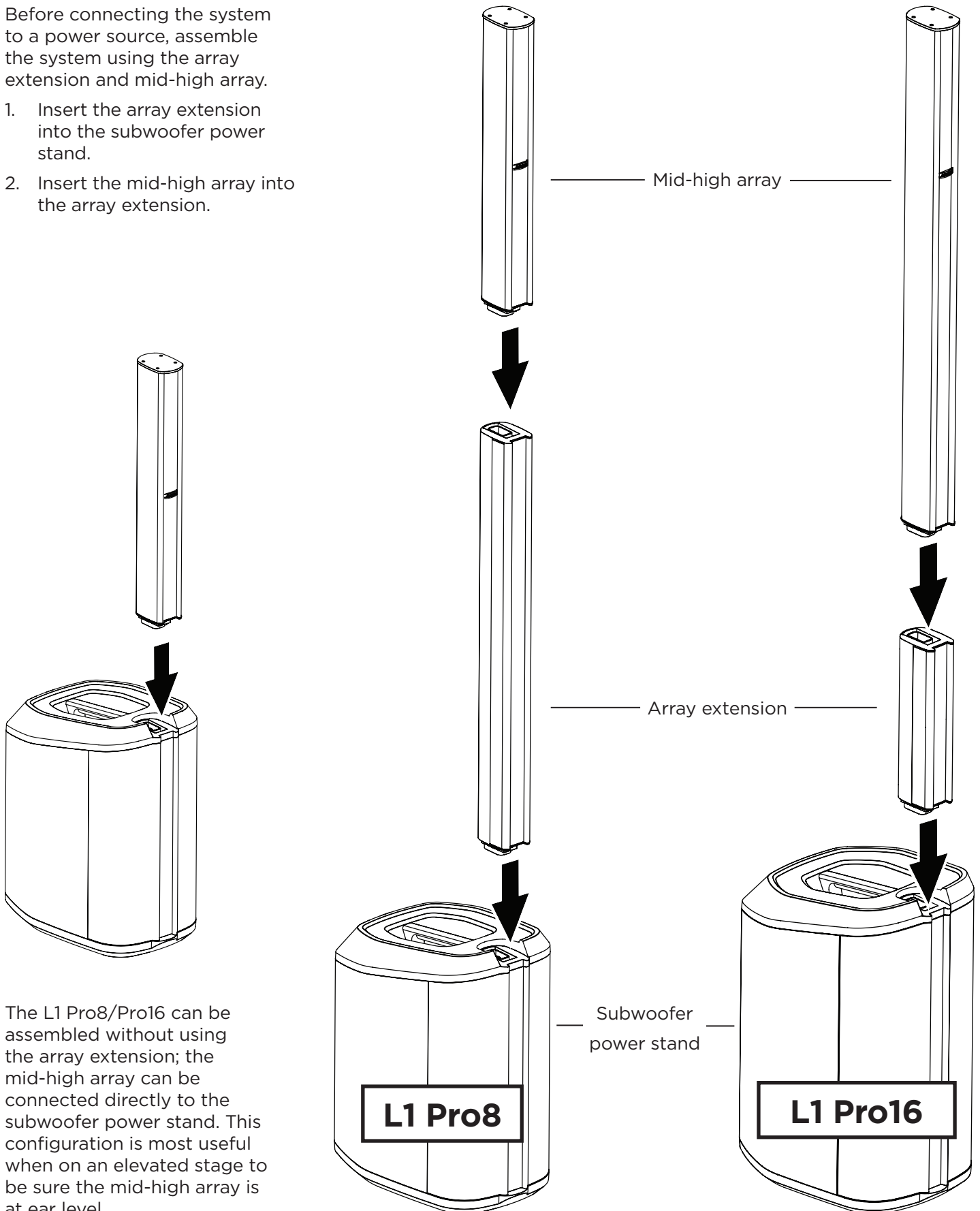

The L1 Pro8/Pro16 can be assembled without using the array extension; the mid-high array can be connected directly to the subwoofer power stand. This configuration is most useful when on an elevated stage to be sure the mid-high array is at ear level.

## Connecting Power

1. Plug the power cord into the **Power Input** on the L1 Pro.
2. Plug the other end of the power cord into a live electrical outlet.

**Note:** Do not power on the system until after you've connected your sources. See **Connecting Sources** below.

3. Press the **Standby Button**. The LED will illuminate white while the system is on.

**Note:** Press and hold the **Standby Button** for 10 seconds to reset the system to factory settings.

## AutoOff/Low-power Standby

After four hours of no use, the L1 Pro will enter AutoOff/Low-power Standby mode to save power. To wake the system from AutoOff/Low-power Standby mode, press the **Standby Button**.

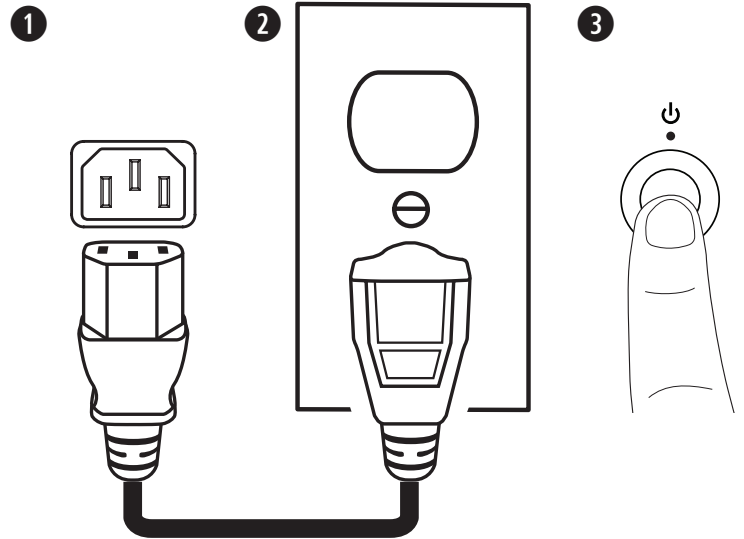

## Connecting Sources

### Channel 1 & 2 Controls

Channel 1 and 2 are for use with microphones, guitars, keyboards, or other instruments. Channel 1 and 2 will automatically detect a source input level to adjust volume taper and gain stage.

1. Connect your sound source to the **Channel Input** with the appropriate cable.
2. Apply a ToneMatch preset—to optimize the sound of your microphone or instrument—by pressing the **Channel ToneMatch Button** until the LED for your chosen preset is illuminated. Use **MIC** for microphones and use **INST** for acoustic guitars and other instruments. Use **OFF** if you do not want to apply a preset.

**Note:** Use the L1 Mix app to choose custom presets from the ToneMatch library. The corresponding LED will illuminate green when a custom preset is selected.

3. Press the **Channel Parameter Control** to choose a parameter to modify. The parameter name will illuminate white while it is selected.
4. Rotate the **Channel Parameter Control** to adjust the level of the selected parameter. The parameter LED will indicate the level of the selected parameter.

**Note:** While **Reverb** is selected, press and hold the control for two seconds to mute the reverb. While reverb is muted, **Reverb** will flash white. To unmute reverb, press and hold for two seconds while **Reverb** is selected. Reverb mute will reset when the system is powered off.

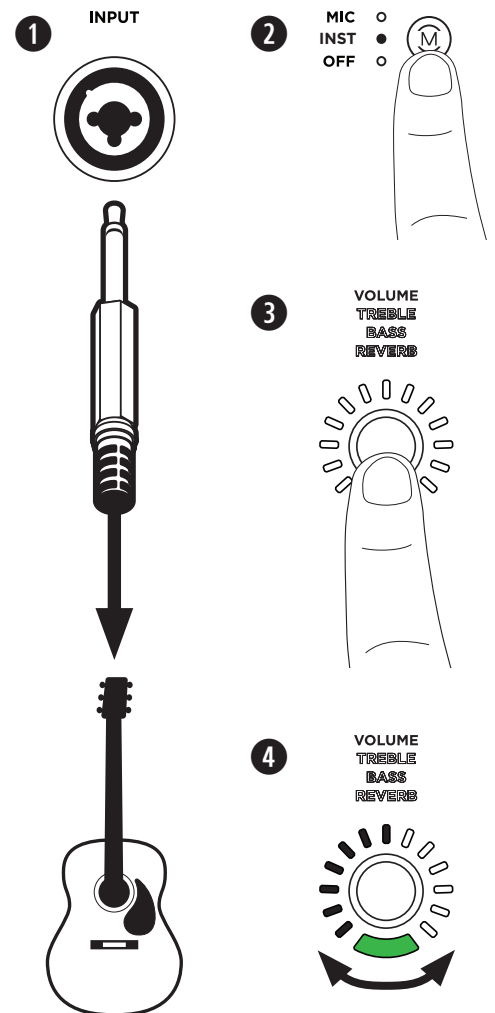



## Channel 3 Controls

Channel 3 is for use with *Bluetooth*® enabled devices and line-level audio inputs.

### Bluetooth Pairing

The following steps describe how to manually connect a *Bluetooth* enabled device to stream audio.

You can use the L1 Mix app to access additional device control. For more information on the L1 Mix app, see **L1 Mix App Control** below.

1. Turn on the *Bluetooth* feature on your mobile device.
2. Press and hold the **Bluetooth Pair Button** for two seconds. When ready to pair, the LED will flash blue.

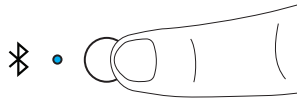

3. Your L1 Pro will be visible in your device list on your mobile device. Select your L1 Pro from the device list. When the device pairs successfully, the LED will illuminate solid white.

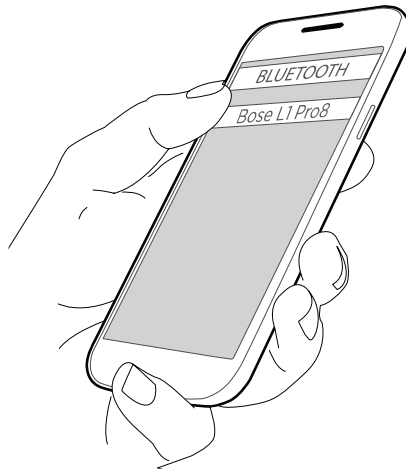

**Note:** Some notifications may be audible through the system while in use. To prevent this, disable notifications on your connected device. Enable airplane mode to prevent call/message notifications from interrupting audio.

### TRS Line Input

A mono input. Use a 6.4-millimeter (¼-inch) TRS cable to connect line-level audio sources, such as mixers or instrument effects.

### Aux Line Input

A stereo input. Use a 3.5-millimeter (⅛-inch) TRS cable to connect a line-level audio source, such as mobile devices or laptops.

## L1 Mix App Control

Download the Bose L1 Mix app for additional device control and audio streaming. Once downloaded, follow the instructions in the app to connect your L1 Pro. For specific information on how to use the L1 Mix App, see the in-app help.



### Features

- Adjust channel volume
- Adjust channel mixer parameters
- Adjust system EQ
- Enable channel mute
- Enable reverb mute
- Enable phantom power
- Access to ToneMatch preset library
- Save scenes

## Additional Adjustments

### Channel Mute

Press the **Channel Mute** to mute the audio for an individual channel. While a channel is muted, the button will illuminate white. Press the button again to unmute the channel.

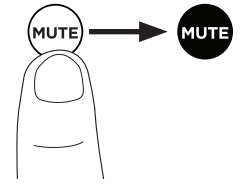

### Phantom Power

Press the **Phantom Power** button to apply 48-volt power to channels 1 and 2. The LED will illuminate white while phantom power is applied. Apply phantom power when using a condenser microphone. Press the button again to turn off phantom power.

**Note:** Phantom power will only affect sources connected to a **Channel Input** using an XLR cable.

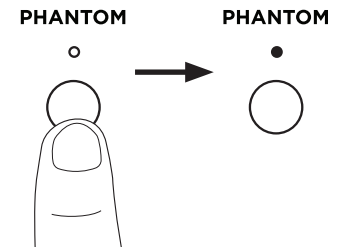

### System EQ

Select your system EQ by pressing the **System EQ** button until the corresponding LED for your desired EQ illuminates white. Choose between **OFF**, **LIVE**, **MUSIC**, and **SPEECH**. Your chosen EQ will stay selected when you power off and power on your L1 Pro.

**Note:** The system EQ affects subwoofer/mid-high array audio only. **System EQ** does not affect **XLR Line Output** audio.

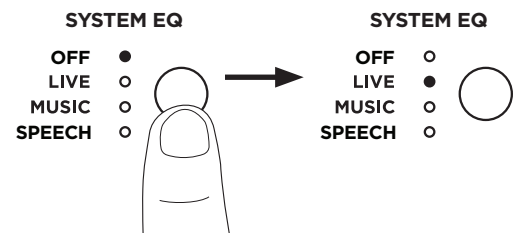

### System Setup Scenarios

The L1 Pro8/Pro16 system can be placed on the floor or on an elevated stage. When using the system on an elevated stage, assemble your system without the array extension (see **Assembling the System** on page 7).

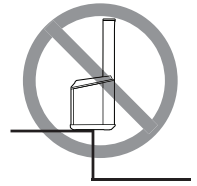

**WARNING:** Do not place the equipment in an unstable location. The equipment could become unstable leading to a hazardous condition, which could result in injury.

L1 Pro8

L1 Pro16

Floor

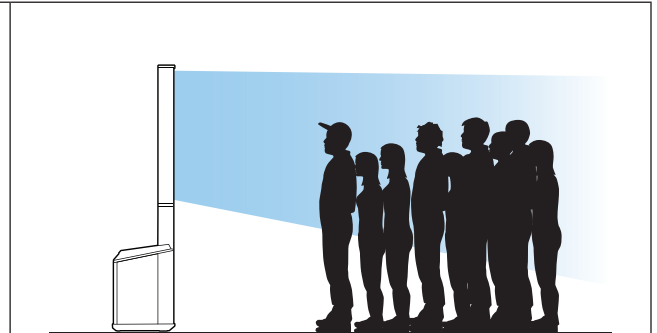
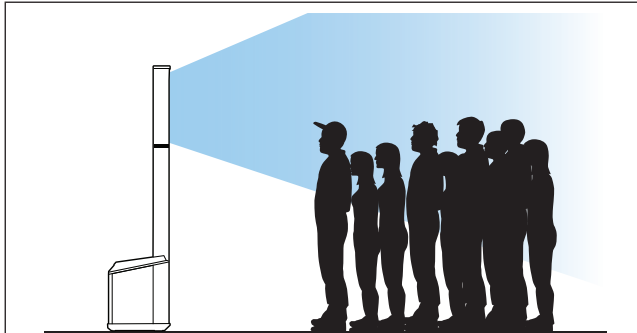

Stage

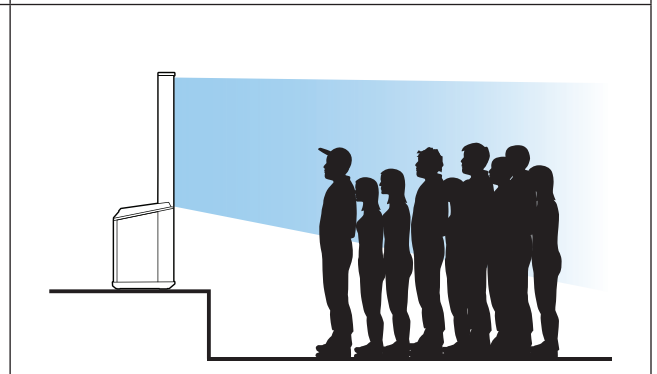
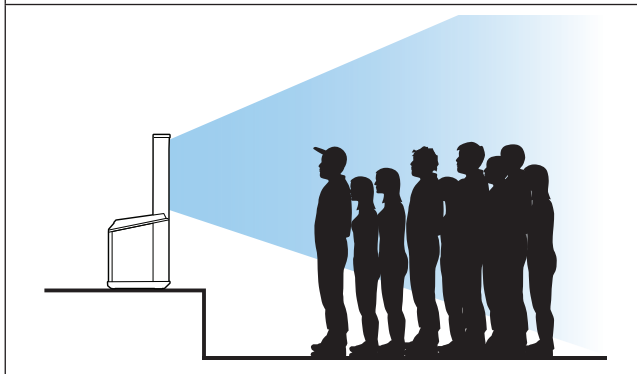

### Solo Musician

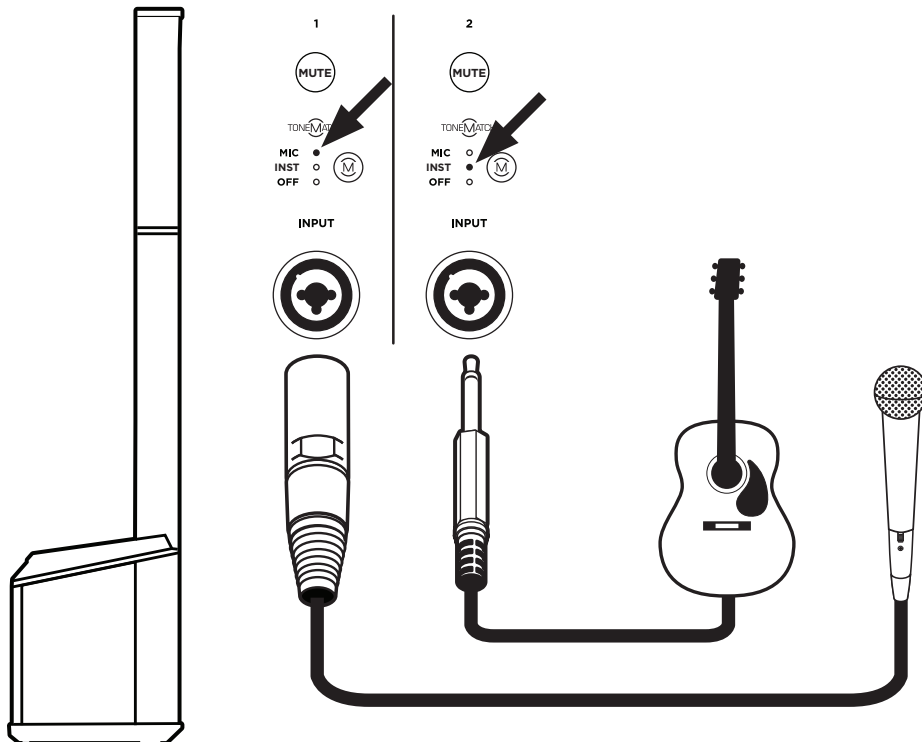

### Musician with Mobile Device

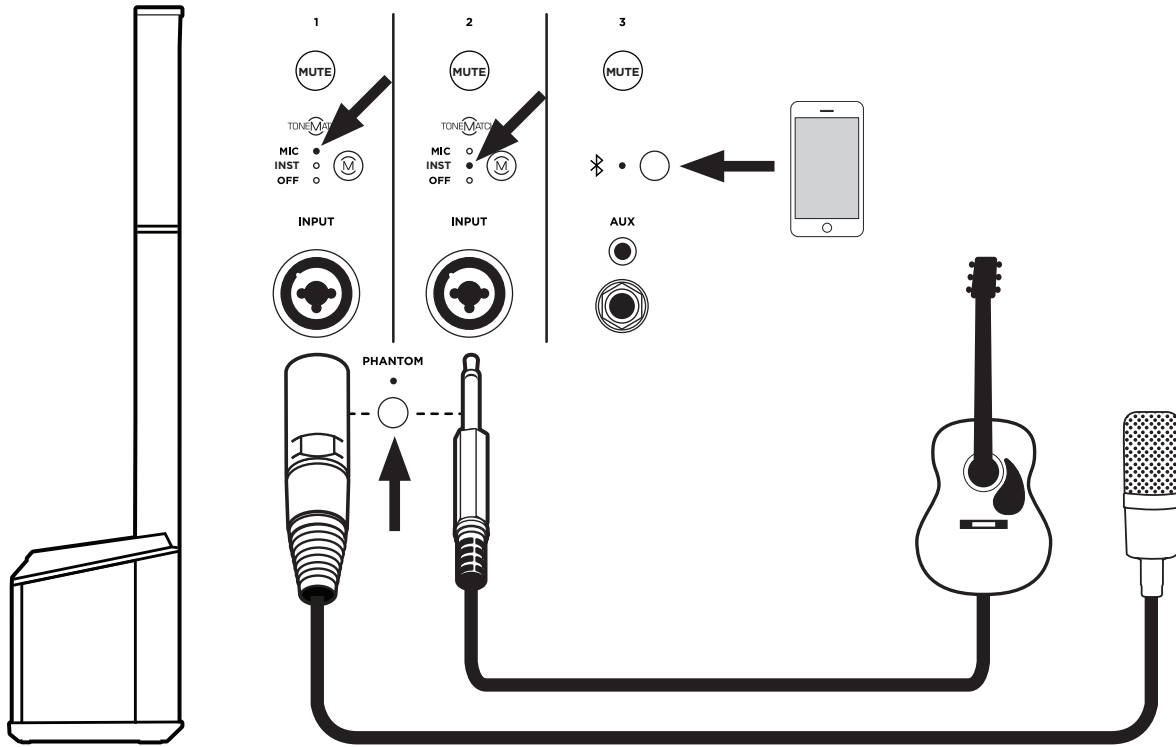

### Band

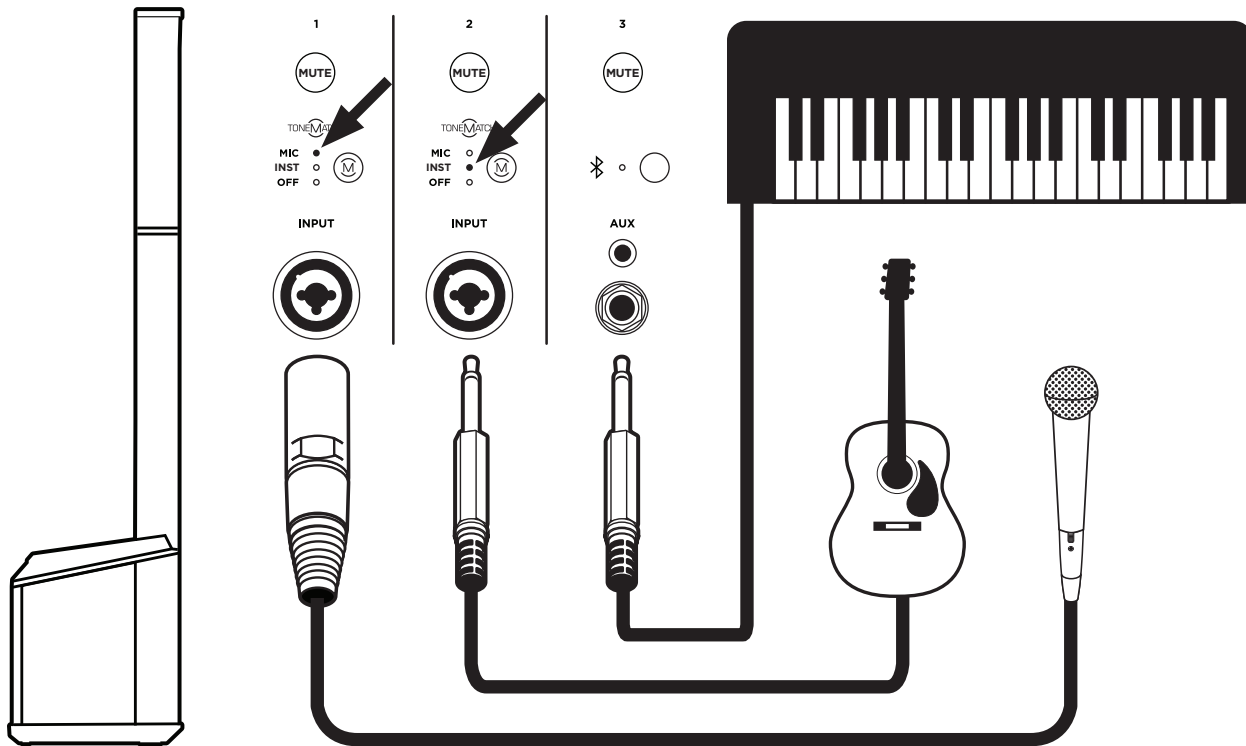

### Musician with T8S Mixer

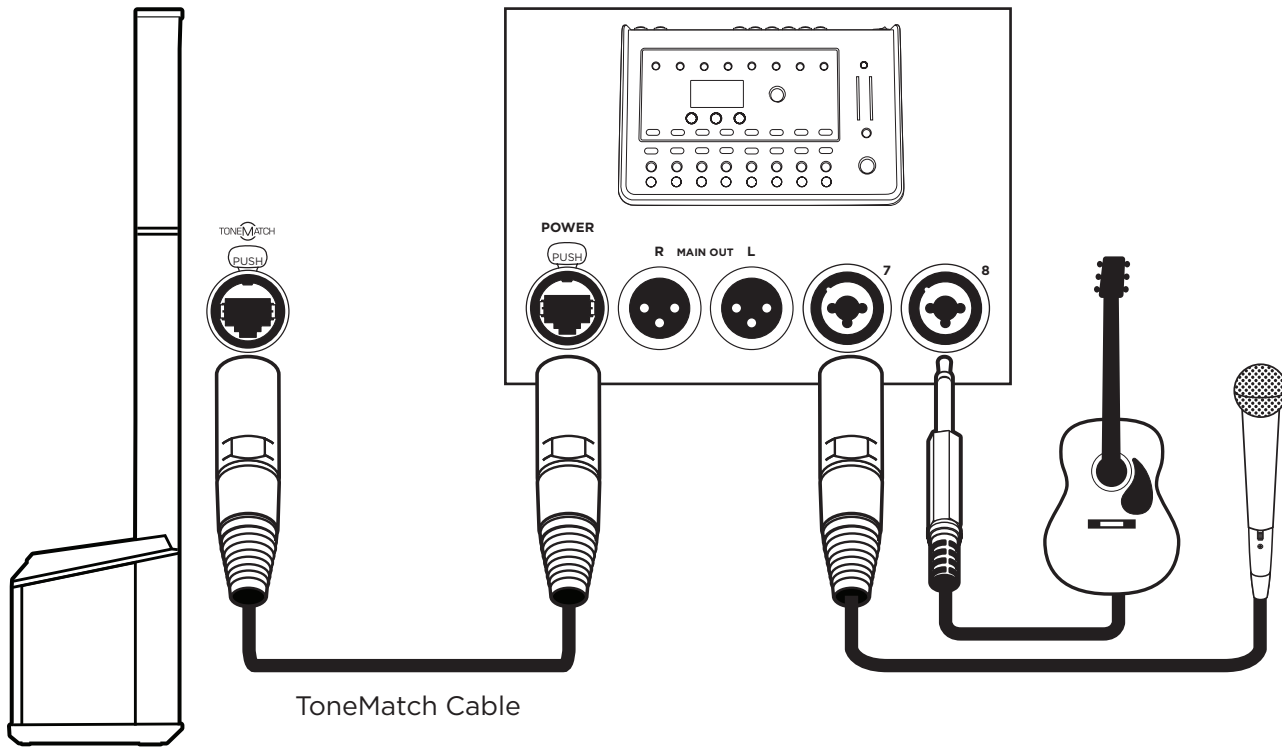

**Note:** T8S left channel audio is delivered only.

### Musician Stereo with T4S Mixer

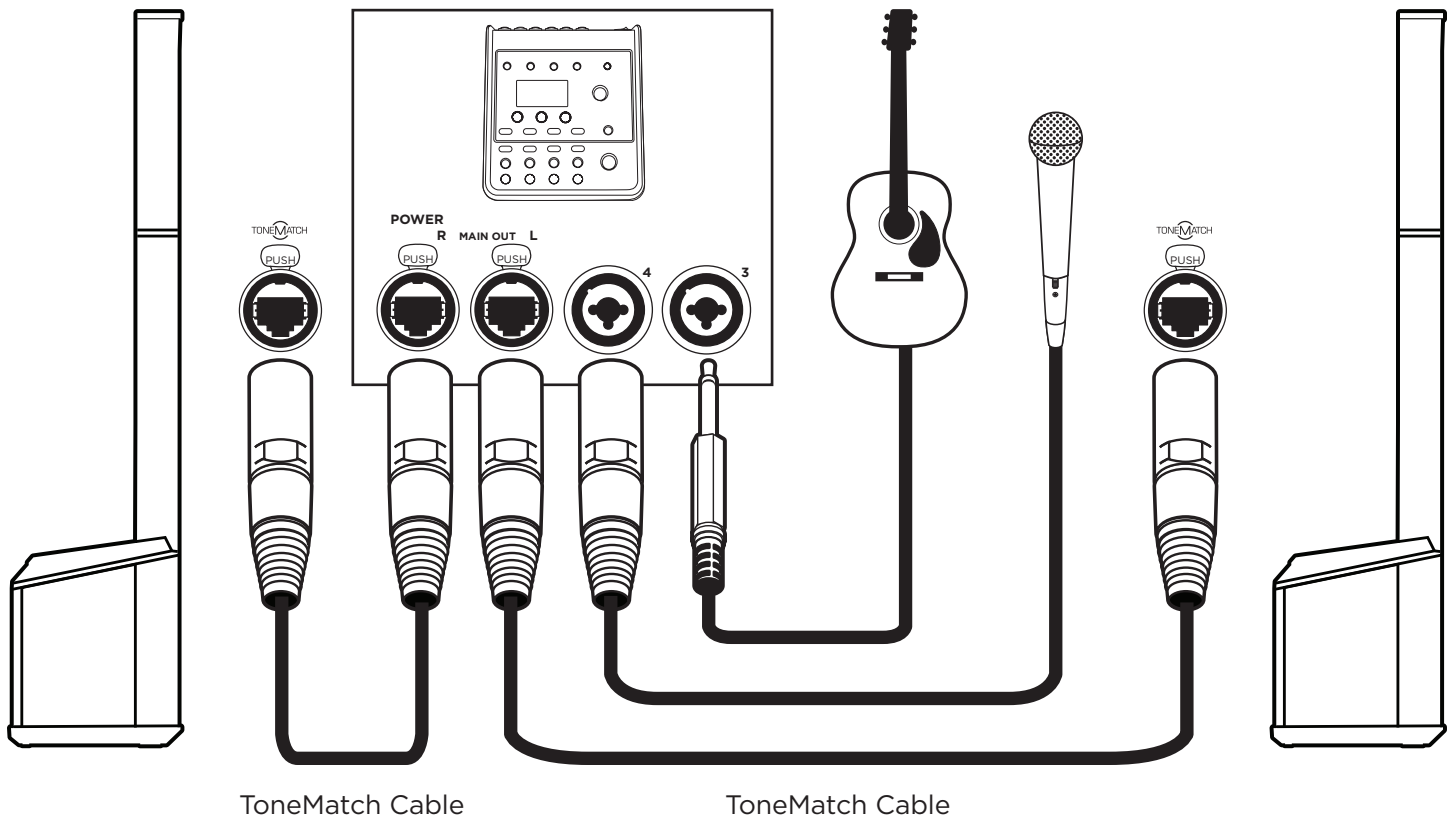

DJ Stereo

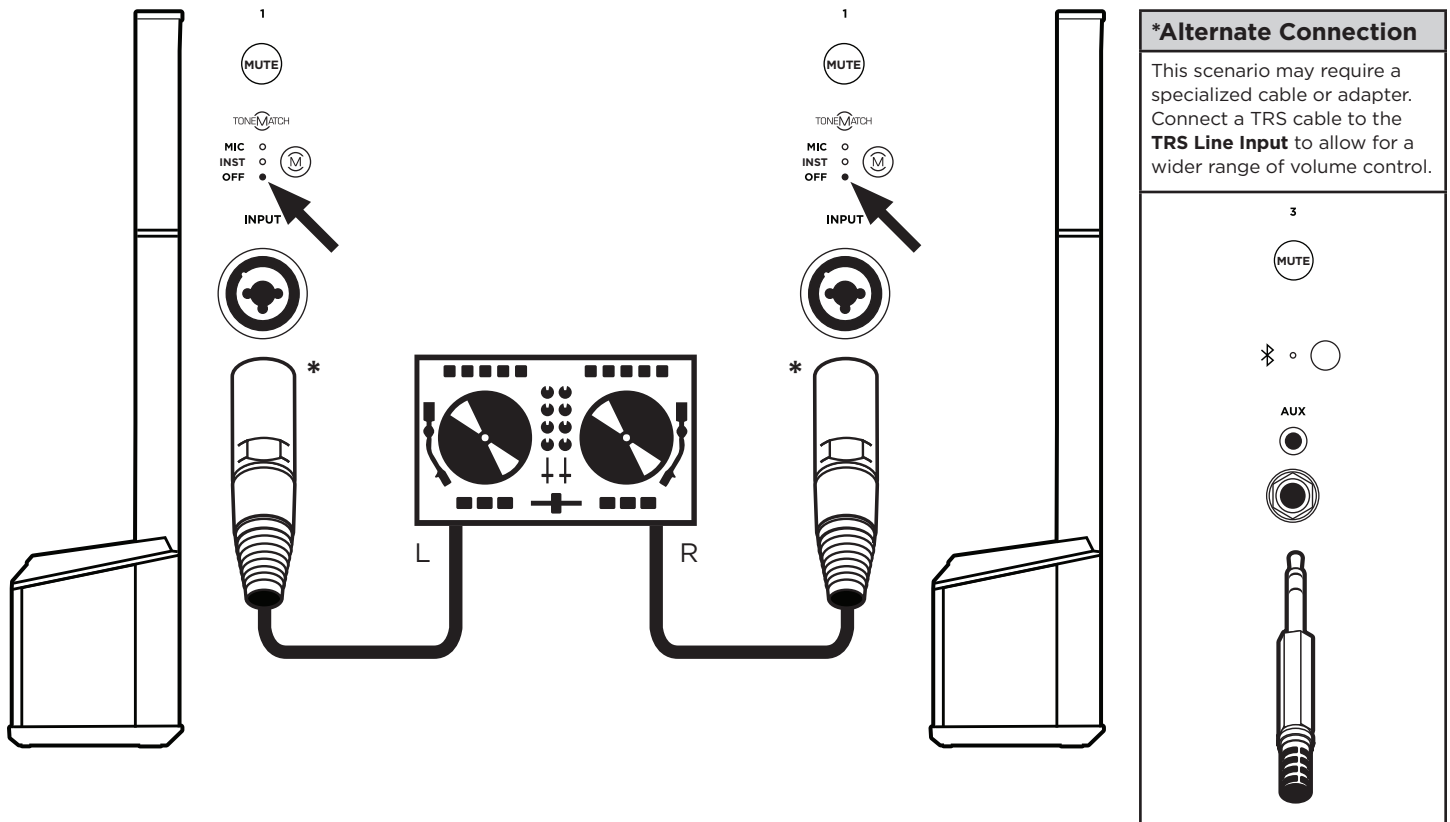

DJ with Sub1

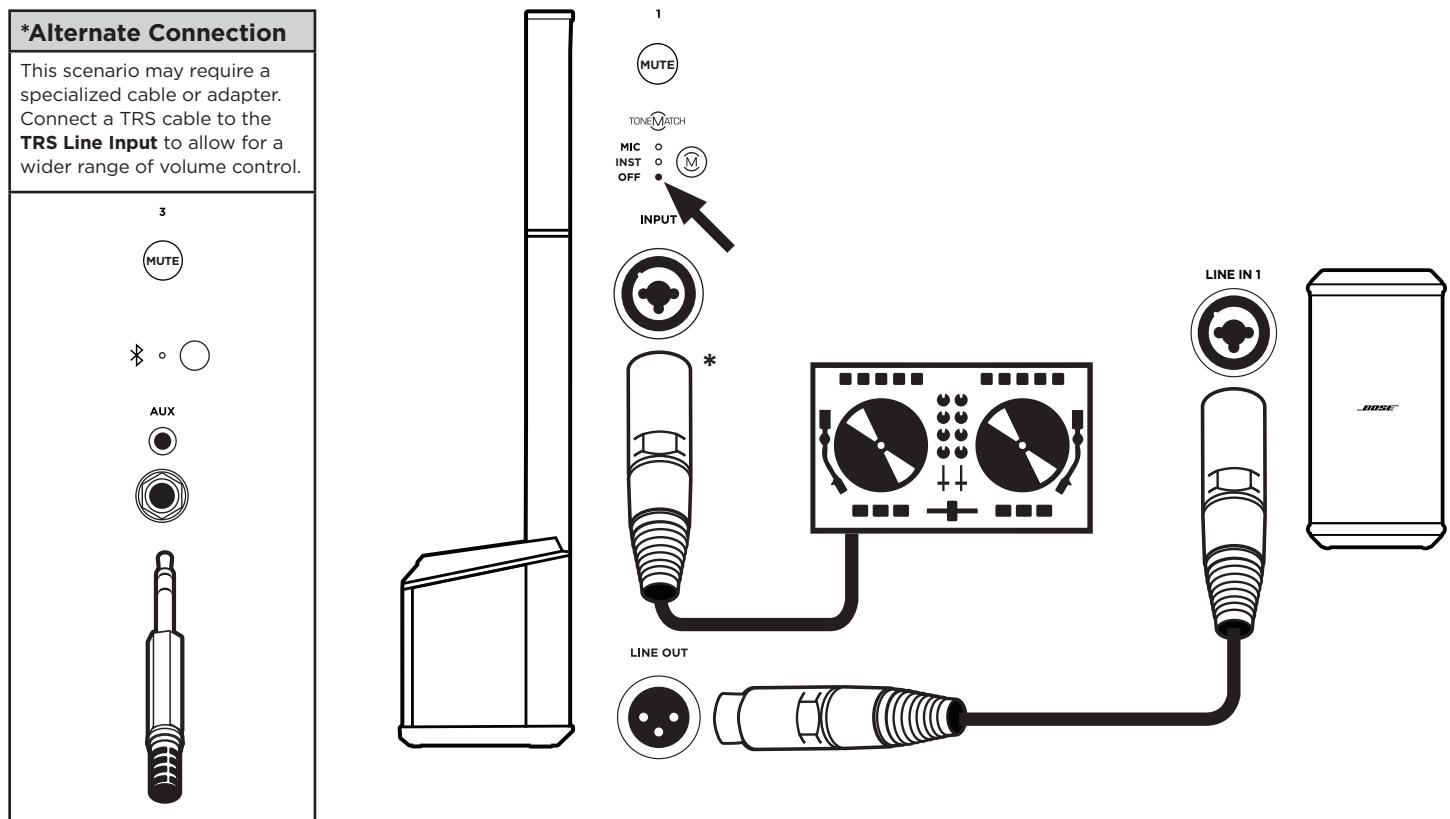

**Note:** For proper Sub1/Sub2 settings, see the Sub1/Sub2 owner's guide at [PRO.BOSE.COM](http://PRO.BOSE.COM).

### Musician Dual Mono

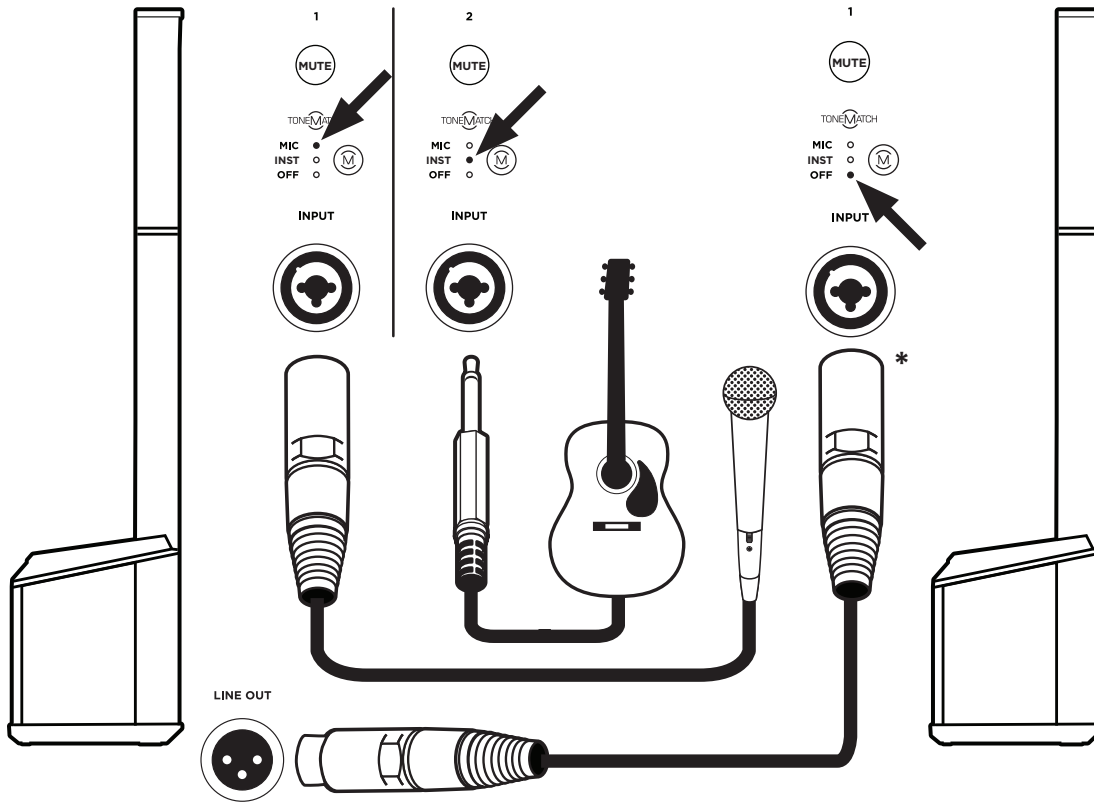

**\*Alternate Connection**

This scenario requires a specialized cable or adapter. Connect a TRS cable to the **TRS Line Input** to allow for a wider range of volume control.

### Musician with S1 Pro Monitor

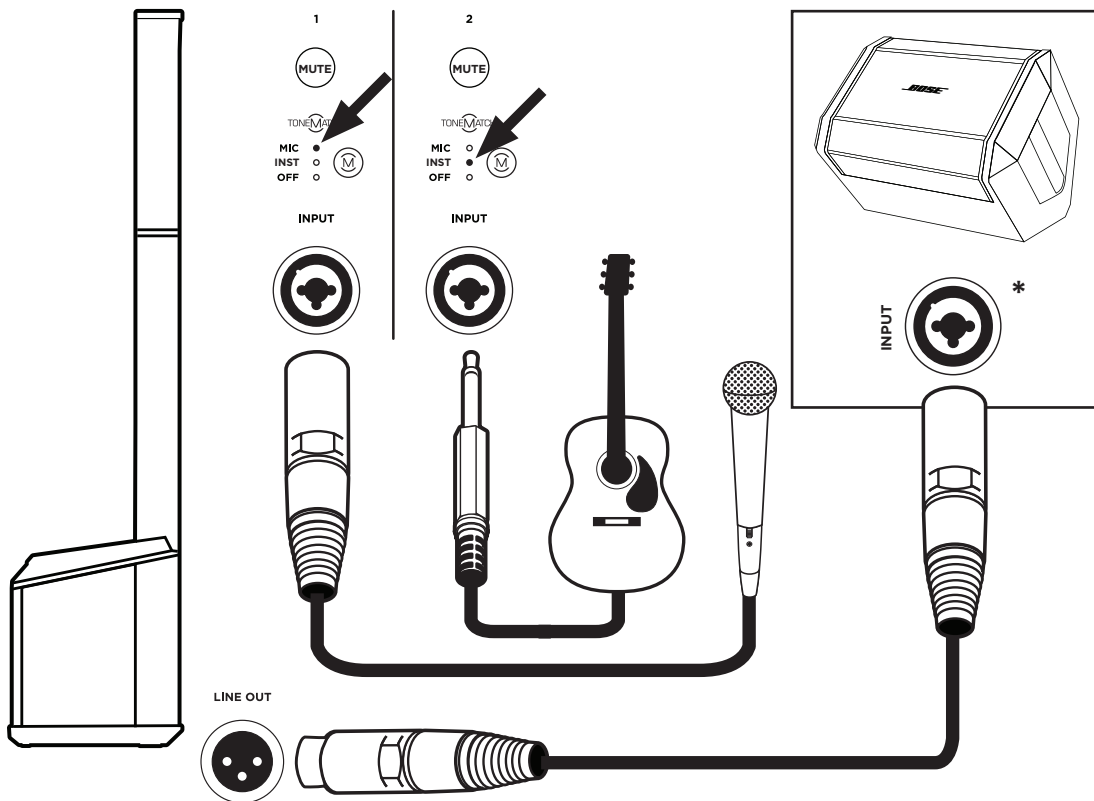

**\*Alternate Connection**

This scenario requires a specialized cable or adapter. Connect a TRS cable to allow for a wider range of volume control.

## Care & Maintenance

### Cleaning Your L1 Pro

Clean the product enclosure using only a soft, dry cloth. If necessary, carefully vacuum the grille of the L1 Pro.



**CAUTION:** Do not use any solvents, chemicals, or cleaning solutions containing alcohol, ammonia, or abrasives.

**CAUTION:** Do not use any sprays near the product or allow liquids to spill into any openings.

### Troubleshooting

Problem	What to do
<b>No power</b>	<ul style="list-style-type: none"> <li>Make sure you have power at the AC outlet. Try operating a lamp or other equipment from the same AC outlet or test the outlet using an AC outlet tester.</li> </ul>
<b>No sound</b>	<ul style="list-style-type: none"> <li>Make sure your L1 Pro is turned on.</li> <li>Make sure your instrument is plugged into the <b>Channel Input</b>.</li> <li>Make sure the volume is turned up on your source.</li> <li>Make sure the volume is turned up on the L1 Pro.</li> <li>Make sure the L1 Pro isn't in AutoOff/Low-power Standby mode.</li> <li>Plug your instrument into a different amplifier to make sure the source is working.</li> <li>Make sure the <b>Channel Mute</b> button is not engaged.</li> </ul>
<b>Standby LED is flashing red (thermal fault)</b>	<ul style="list-style-type: none"> <li>Turn off the L1 Pro and wait 30 minutes before turning it back on.</li> <li>Move the L1 Pro to a cooler location.</li> <li>Move the L1 Pro to a location that has more ventilation.</li> </ul>
<b>Standby LED is solid red (system fault)</b>	<ul style="list-style-type: none"> <li>Please call Product and Technical Support at (877) 335-2673.</li> </ul>
<b>With nothing plugged into the L1 Pro, a light hum or buzz is heard</b>	<ul style="list-style-type: none"> <li>Using an AC outlet tester, test the AC outlet the L1 Pro is plugged into for reversed or open (hot, neutral, and/or ground) contacts.</li> <li>If using an extension cord, plug the L1 Pro directly into the outlet.</li> </ul>
<b>Instrument or audio source sounds distorted</b>	<ul style="list-style-type: none"> <li>Turn down volume on the source.</li> <li>Turn down channel volume.</li> <li>Try a different source or instrument.</li> </ul>
<b>Microphone is encountering feedback</b>	<ul style="list-style-type: none"> <li>Turn down channel volume.</li> <li>Orient the microphone so that it is not pointing directly at the L1 Pro.</li> <li>Try a different microphone.</li> <li>Try a different position for the L1 Pro and/or vocalist on stage.</li> <li>Increase the distance from the L1 Pro to the microphone.</li> <li>If using a vocal effects processor, make sure it is not contributing to the feedback problem.</li> </ul>



Problem	What to do
<p><b>Paired <i>Bluetooth</i><sup>®</sup> device will not connect to the loudspeaker</b></p>	<ul style="list-style-type: none"> <li>• If your paired device requires a passcode, make sure the one you entered is correct.</li> <li>• Make sure <i>Bluetooth</i><sup>®</sup> functionality is turned on or enabled on your source device.</li> <li>• Your <i>Bluetooth</i> device may be out of range; try moving it closer to the L1 Pro.</li> <li>• If possible, turn off all other nearby <i>Bluetooth</i> devices or disable their <i>Bluetooth</i> functionality.</li> <li>• Clear the loudspeaker memory or pair to a new device by pressing and holding the <b><i>Bluetooth</i> Pair Button</b> for ten seconds. Delete the L1 Pro from the <i>Bluetooth</i> device's memory. Pair the <i>Bluetooth</i> device with the L1 Pro again.</li> <li>• Turn the power off and back on; then try re-pairing your device.</li> </ul>
<p><b>Excessive hum when daisy-chaining multiple units</b></p>	<ul style="list-style-type: none"> <li>• Ensure the volume on the daisy-chained unit(s) is not set too high.</li> </ul>



857135-0010

©2020 Bose Corporation, All rights reserved.  
Framingham, MA 01701-9168 USA  
PRO.BOSE.COM  
AM857135 Rev. 00  
August 2020

