

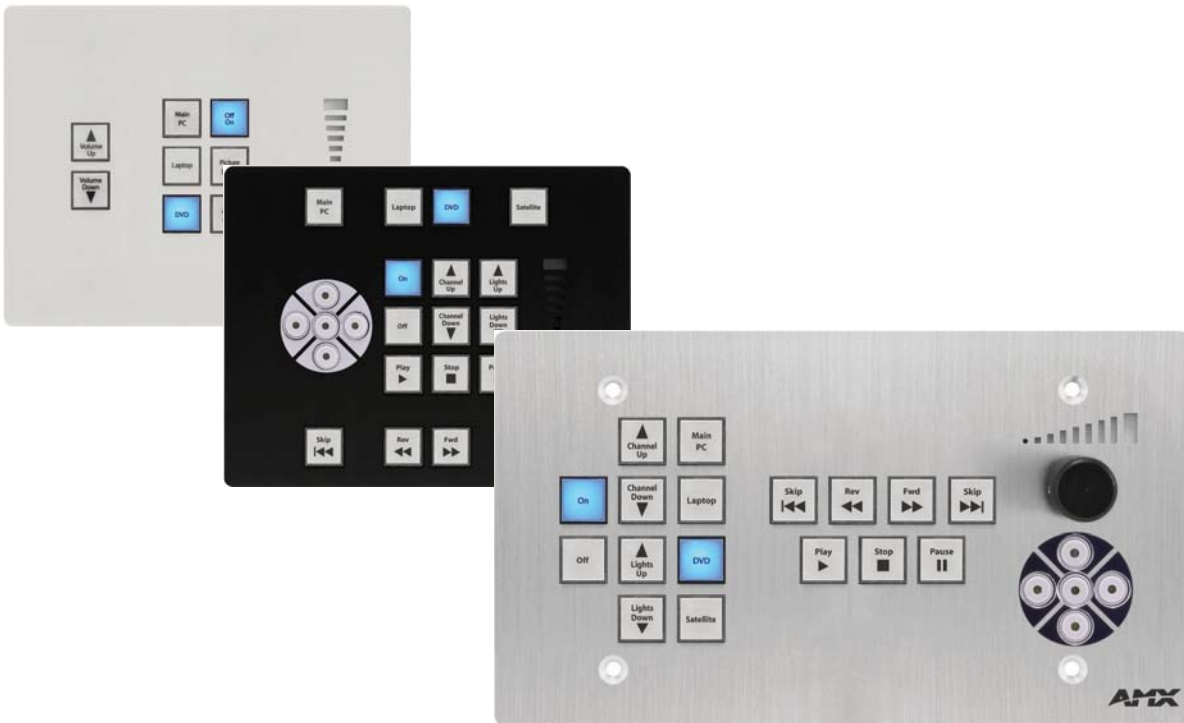

INSTRUCTION MANUAL

# NOVARA 3000 SERIES CONTROLPADS

CP-3006, CP-3008, CP-3017-NA, CP-3017-TR-US



## IMPORTANT SAFETY INSTRUCTIONS

1. READ these instructions.
2. KEEP these instructions.
3. HEED all warnings.
4. FOLLOW all instructions.
5. DO NOT use this apparatus near water.
6. CLEAN ONLY with dry cloth.
7. DO NOT block any ventilation openings. Install in accordance with the manufacturer's instructions.
8. DO NOT install near any heat sources such as radiators, heat registers, stoves, or other apparatus (including amplifiers) that produce heat.
9. DO NOT defeat the safety purpose of the polarized or grounding type plug. A polarized plug has two blades with one wider than the other. A grounding type plug has two blades and a third grounding prong. The wider blade or the third prong are provided for your safety. If the provided plug does not fit into your outlet, consult an electrician for replacement of the obsolete outlet.
10. PROTECT the power cord from being walked on or pinched, particularly at plugs, convenience receptacles, and the point where they exit from the apparatus.
11. ONLY USE attachments/accessories specified by the manufacturer.



12. USE ONLY with a cart, stand, tripod, bracket, or table specified by the manufacturer, or sold with the apparatus. When a cart is used, use caution when moving the cart/apparatus combination to avoid injury from tip-over.
13. UNPLUG this apparatus during lightning storms or when unused for long periods of time.
14. REFER all servicing to qualified service personnel. Servicing is required when the apparatus has been damaged in any way, such as power-supply cord or plug is damaged, liquid has been spilled or objects have fallen into the apparatus, the apparatus has been exposed to rain or moisture, does not operate normally, or has been dropped.
15. DO NOT expose this apparatus to dripping or splashing and ensure that no objects filled with liquids, such as vases, are placed on the apparatus.
16. To completely disconnect this apparatus from the AC Mains, disconnect the power supply cord plug from the AC receptacle.
17. Where the mains plug or an appliance coupler is used as the disconnect device, the disconnect device shall remain readily operable.
18. DO NOT overload wall outlets or extension cords beyond their rated capacity as this can cause electric shock or fire.



The exclamation point, within an equilateral triangle, is intended to alert the user to the presence of important operating and maintenance (servicing) instructions in the literature accompanying the product.



The lightning flash with arrowhead symbol within an equilateral triangle is intended to alert the user to the presence of uninsulated "dangerous voltage" within the product's enclosure that may be of sufficient magnitude to constitute a risk of electrical shock to persons.



ESD Warning: The icon to the left indicates text regarding potential danger associated with the discharge of static electricity from an outside source (such as human hands) into an integrated circuit, often resulting in damage to the circuit.

- WARNING:** To reduce the risk of fire or electrical shock, do not expose this apparatus to rain or moisture.
- WARNING:** No naked flame sources - such as lighted candles - should be placed on the product.
- WARNING:** Equipment shall be connected to a MAINS socket outlet with a protective earthing connection.
- WARNING:** To reduce the risk of electric shock, grounding of the center pin of this plug must be maintained.

## COPYRIGHT NOTICE

AMX© 2016, all rights reserved. No part of this publication may be reproduced, stored in a retrieval system, or transmitted, in any form or by any means, electronic, mechanical, photocopying, recording, or otherwise, without the prior written permission of AMX. Copyright protection claimed extends to AMX hardware and software and includes all forms and matters copyrightable material and information now allowed by statutory or judicial law or herein after granted, including without limitation, material generated from the software programs which are displayed on the screen such as icons, screen display looks, etc. Reproduction or disassembly of embodied computer programs or algorithms is expressly prohibited.

## LIABILITY NOTICE

No patent liability is assumed with respect to the use of information contained herein. While every precaution has been taken in the preparation of this publication, AMX assumes no responsibility for error or omissions. No liability is assumed for damages resulting from the use of the information contained herein. Further, this publication and features described herein are subject to change without notice.

## AMX WARRANTY AND RETURN POLICY

The AMX Warranty and Return Policy and related documents can be viewed/downloaded at [www.amx.com](http://www.amx.com).

# Table of Contents

<b>NOVARA 3000 Series ControlPads .....</b>	<b>6</b>
<b>Overview .....</b>	<b>6</b>
<b>Product Specifications .....</b>	<b>7</b>
CP-3006 .....	7
CP-3008 .....	7
CP-3017-TR-US & -NA .....	8
<b>Mounting Specifications - 6-Button ControlPads.....</b>	<b>10</b>
CP-3006 .....	10
<b>Mounting Specifications - 8-Button ControlPads.....</b>	<b>11</b>
CP-3008 .....	11
<b>Mounting Specifications - 17-Button ControlPads .....</b>	<b>12</b>
CP-3017-TR-US .....	12
CP-3017-NA.....	13
<b>Button Layout .....</b>	<b>14</b>
CP-3006 .....	14
CP-3008 .....	14
CP-3017-NA.....	14
CP-3017-TR-US .....	15
<b>Wiring and Device Connections .....</b>	<b>16</b>
<b>Overview .....</b>	<b>16</b>
<b>Rear Panel Components .....</b>	<b>17</b>
Power .....	17
RS-232 .....	17
RELAYS.....	18
I/O.....	18
IR.....	18
LAN (RJ-45).....	19
<b>Resetting the ControlPad .....</b>	<b>19</b>
<b>CP-RC01 IR Remote .....</b>	<b>20</b>
Product Specifications.....	20
Button Functions .....	20
IR Remote Codes .....	21
<b>PS-PoE-EX0.9 PoE Extractor.....</b>	<b>22</b>
Product Specifications.....	22
Connection.....	23
Power Cable Wiring .....	23
<b>Button Labeling .....</b>	<b>24</b>
<b>Overview .....</b>	<b>24</b>
Installing Acetate Button Labels and Key Caps - READ THIS FIRST! .....	24

<b>Removing/Replacing Button Labels</b> .....	<b>25</b>
Disassembling the NOVARA ControlPad.....	25
Replacing Key Caps / Button Labels.....	25
Re-Assembling the ControlPad.....	26
CP-3008 Reassembly.....	26
CP-3017-NA Reassembly .....	27
CP-3017-TR-US Reassembly .....	27
<b>Device Configuration Software</b> .....	<b>28</b>
<b>Overview</b> .....	<b>28</b>
Setting Your Bonjour Preference.....	29
<b>Project Device Configuration</b> .....	<b>30</b>
Modifying a ControlPad in the Device Layout.....	31
Creating a New Project .....	32
Adding a Node to the Device Layout.....	32
Renaming Tree Nodes .....	32
Relocating Tree Nodes.....	32
Tagging Devices.....	32
Configuring Global Settings.....	33
Enabling the HTTP Web Server .....	34
Configuring Device Settings .....	34
<b>Device Interface</b> .....	<b>35</b>
<b>Device Setup</b> .....	<b>36</b>
Scripting .....	36
Setup.....	37
Button Backlight .....	37
Button Behavior .....	38
Button Groups.....	39
Volume Control .....	40
Interrogation .....	40
Feedback.....	42
Buttons.....	42
Volume Bar.....	43
RS232.....	43
IR.....	44
Relay .....	45
Output .....	45
Delay .....	46
Lockout Buttons.....	46
Bank Enable .....	47
Advance Toggle .....	48
Button Actions and Events.....	49
Inputs .....	50

Script Types .....	50
<b>Device Library Manager .....</b>	<b>53</b>
Device Interrogation Formulas.....	54
Adding a Device to the Device Library .....	55
Modifying Devices in the Device Library .....	55
Importing a Device Library .....	55
Renaming a Device.....	56
ASCII to Hex Tool .....	56
Test Command Tool.....	57
<b>Updating Firmware.....</b>	<b>58</b>
<b>Web Console .....</b>	<b>59</b>
<b>Overview .....</b>	<b>59</b>
Changing the Image Logo on the Web Pages .....	59
Device Information Page .....	60
Remote Control Page.....	60
<b>RMS Configuration .....</b>	<b>61</b>
<b>Overview .....</b>	<b>61</b>
<b>Installation Checklist .....</b>	<b>61</b>
Installing the CP-RMS Proxy.....	61
Upgrading the CP-RMS Proxy .....	62
Editing the Configuration File .....	62
Starting the CP-RMS Service .....	63
RMS Control Functions and Macros.....	63
Device Interrogation.....	63

# NOVARA 3000 Series ControlPads

## Overview

NOVARA 3000 Series ControlPads offer the ability to easily control presentation devices such as projectors, projection screens, video displays, and other audio visual equipment as well as a variety of serial or IR-controllable devices like lighting and window treatments. NOVARA ControlPads are designed to be easily configurable allowing control of equipment by RS232 commands and IR.

The ControlPads are configured using the *AMX DCS Device Configuration Software* software application, available for download from [www.amx.com](http://www.amx.com). Refer to the *Device Configuration Software* section on page 28 for more information.

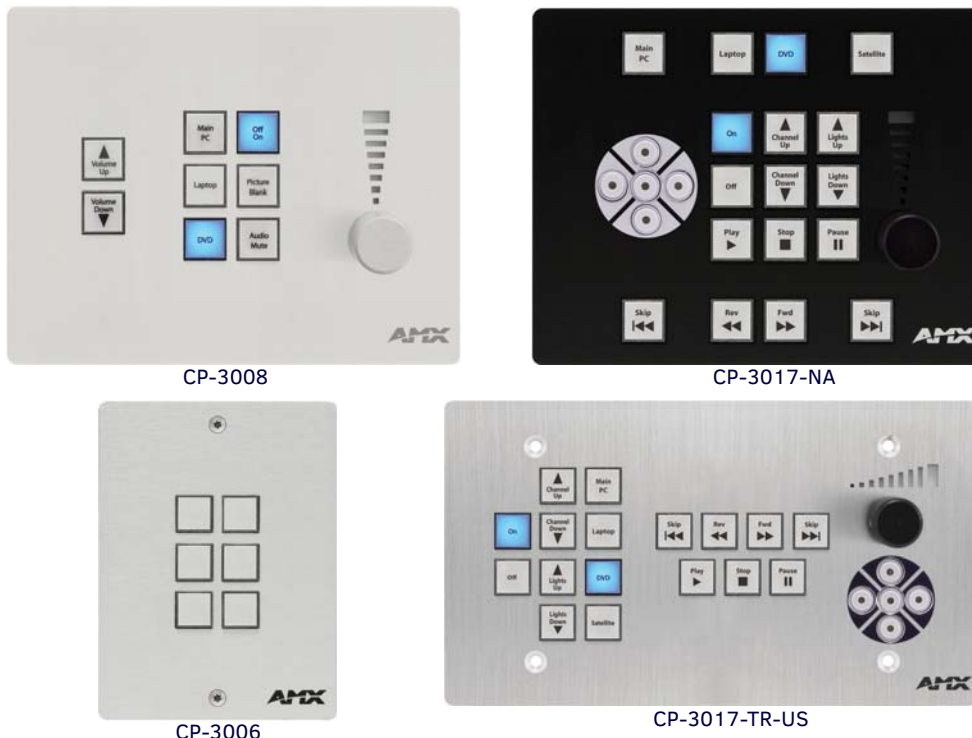

**FIG. 1** NOVARA 3000 Series ControlPads

The NOVARA 3000 Series of ControlPads include:

NOVARA 3000 Series ControlPads		
Name	Description	Colors/FG#s
CP-3006 6-Button ControlPad	Fits standard 1-gang US, UK, and EU back box sizes.	<ul style="list-style-type: none"> <li>Aluminum: FG1302-06-A</li> <li>Black: FG1302-06-B</li> <li>White: FG1302-06-W</li> </ul>
CP-3008 8-Button ControlPad	Fits standard 2-gang US, UK, and EU back box sizes.	<ul style="list-style-type: none"> <li>Aluminum: FG1302-08-A</li> <li>Black: FG1302-08-B</li> <li>White: FG1302-08-W</li> </ul>
CP-3017-TR-US 17-Button ControlPad	Fits standard 4-gang US back box sizes.	<ul style="list-style-type: none"> <li>Aluminum: FG1302-17-4-SA</li> <li>Black: FG1302-17-4-SB</li> <li>White: FG1302-17-4-SW</li> </ul>
CP-3017-NA 17-Button ControlPad	Fits standard 2-gang US, UK, and EU back box sizes.	<ul style="list-style-type: none"> <li>Aluminum: FG1302-17-2-A</li> <li>Black: FG1302-17-2-B</li> <li>White: FG1302-17-2-W</li> </ul>

## Product Specifications

### CP-3006

NOVARA CP-3006 ControlPad	
Power Requirements:	<ul style="list-style-type: none"> <li>Min: 109mA@12 V<sub>DC</sub></li> <li>Max: 220mA@12 V<sub>DC</sub></li> <li>Using a non-PoE power supply operates on voltages ranging from 9V to 16V continuously.</li> </ul>
Button Layout:	6 blue back-lit buttons with programmable feedback
Colors:	<ul style="list-style-type: none"> <li>Aluminum: FG1302-06-A</li> <li>Black: FG1302-06-B</li> <li>White: FG1302-06-W</li> </ul>
Rear Panel Connectors	
Power	One 2-pin Phoenix connector accepting 12V <sub>DC</sub> power
Serial	One 3-pin Phoenix connector for RS-232 connection. Input voltage: <ul style="list-style-type: none"> <li>V<sub>IH</sub> &gt; +2.7 V<sub>DC</sub>,</li> <li>V<sub>IL</sub> &lt; -2.7 V<sub>DC</sub></li> </ul> Output voltage: <ul style="list-style-type: none"> <li>V<sub>OH</sub> &gt; +5.0 V<sub>DC</sub> @ 35 mA maximum,</li> <li>V<sub>OL</sub> &lt; -5.0 V<sub>DC</sub> @ 35 mA maximum</li> </ul>
IR	One 2-pin Phoenix connector for IR emitters. Supports generating carriers up to 1.142 MHz. Output only port. Output voltage: <ul style="list-style-type: none"> <li>V<sub>OH</sub> = +3.3 V<sub>DC</sub> +/- 0.3 V<sub>DC</sub> @ 13 mA maximum</li> <li>V<sub>OL</sub> = 0 V<sub>DC</sub> +/- 0.3 V<sub>DC</sub> @ 13 mA maximum</li> </ul>
Ethernet	One RJ-45 connector for LAN connectivity.
Reset	One pinhole pushbutton for factory reset.
Supported Baud Rates:	Up to 115200
Dimensions (HWD):	4 11/16" x 3 7/16" x 1 7/16" (11.9cm x 8.8 cm x 3.7 cm)
Operating Environment:	<ul style="list-style-type: none"> <li>Storage temperature range: 14° - 140° F (-10° - 60° C)</li> <li>Operating temperature range: 32° - 104° F (0° - 40° C)</li> <li>Relative humidity: 5% to 85%, non-condensing</li> </ul>
Included Accessories:	<ul style="list-style-type: none"> <li>Power Supply, 90-240VACIN, 12VOUT, 500MA (24-5791-SA)</li> <li>Pre-printed labels (40-0087)</li> </ul>
Other AMX Equipment:	<ul style="list-style-type: none"> <li>CP-RMS, RMS Gateway Module (<b>FG1310-01</b>)</li> <li>CC-NIRC, NetLinX IR Emitter (<b>FG10-000-11</b>)</li> </ul>
Certifications:	FCC Class B, CE, UL, CB Scheme

### CP-3008

NOVARA CP-3008 ControlPad Specifications	
Power Requirements:	<ul style="list-style-type: none"> <li>Min: 121mA@12 V<sub>DC</sub></li> <li>Max: 320mA@12 V<sub>DC</sub></li> <li>Using a non-PoE power supply operates on voltages ranging from 9V to 16V continuously.</li> </ul>
Button Layout:	<ul style="list-style-type: none"> <li>8 red, green, and blue backlit buttons with programmable feedback</li> <li>Pressable volume knob</li> <li>Volume indicator</li> </ul>
Colors:	<ul style="list-style-type: none"> <li>Aluminum: FG1302-08-A</li> <li>Black: FG1302-08-B</li> <li>White: FG1302-08-W</li> </ul>
Rear Panel Connectors	
Power	One 2-pin Phoenix connector accepting 12V <sub>DC</sub> power
Serial	Two 3-pin Phoenix connectors for RS-232 connections. <ul style="list-style-type: none"> <li>Input voltage: V<sub>IH</sub> &gt; +2.7 V<sub>DC</sub>, V<sub>IL</sub> &lt; -2.7 V<sub>DC</sub></li> <li>Output voltage: V<sub>OH</sub> &gt; +5.0 V<sub>DC</sub> @ 35 mA maximum, V<sub>OL</sub> &lt; -5.0 V<sub>DC</sub> @ 35 mA maximum</li> </ul>

<b>NOVARA CP-3008 ControlPad Specifications (Cont.)</b>	
IR	Two 2-pin Phoenix connectors for IR emitters. Supports generating carriers up to 1.142 MHz. Output only port. Output voltage: <ul style="list-style-type: none"> <li>• <math>V_{OH} = +3.3 V_{DC} \pm 0.3 V_{DC}</math> @ 13 mA maximum</li> <li>• <math>V_{OL} = 0 V_{DC} \pm 0.3 V_{DC}</math> @ 13 mA maximum</li> </ul>
I/O	One 4-pin Phoenix connector for I/O connections. Supports sensing contact closure. Input voltage: <ul style="list-style-type: none"> <li>• HIGH (no contact closure): <math>V_{IH} &gt; 2.5 V_{DC}</math></li> <li>• LOW (contact closure): <math>V_{IL} &lt; 0.8 V_{DC}</math></li> </ul> Output voltage: <ul style="list-style-type: none"> <li>• <math>V_{OH} = +3.3 V_{DC} \pm 0.3 V_{DC}</math> (internal 25k Ohm pull-up resistor)</li> <li>• <math>V_{OL} = 0 V_{DC} \pm 0.3 V_{DC}</math> (200 mA maximum sink current)</li> </ul>
Relay	One 4-pin Phoenix connector for relay connections capable of switching $24 V_{DC}$ @ 1A maximum or $28V_{AC}$ @ 1A maximum
LAN	One RJ-45 connector for LAN connectivity.
Reset	One pinhole pushbutton for factory reset (CP-3017-TR-US only, see for location of Reset button access).
Supported Baud Rates:	Up to 115200
Dimensions (HWD):	4 11/16" x 6" x 1 3/4" (including knob) (11.9cm x 15.2 cm x 4.5 cm)
Weight:	0.863 lbs (0.392 kg)
Operating Environment:	<ul style="list-style-type: none"> <li>• Storage temperature range: 14° - 140° F (-10° - 60° C)</li> <li>• Operating temperature range: 32° - 104° F (0° - 40° C)</li> <li>• Relative humidity: 5% to 85%, non-condensing</li> </ul>
Included Accessories:	<ul style="list-style-type: none"> <li>• Power Supply, 90-240VACIN, 12VOUT, 500MA (24-5791-SA)</li> <li>• Pre-printed labels (40-0087)</li> </ul>
Other AMX Equipment:	<ul style="list-style-type: none"> <li>• CP-RMS, RMS Gateway Module (<b>FG1310-01</b>)</li> <li>• CC-NIRC, NetLinX IR Emitter (<b>FG10-000-11</b>)</li> </ul>
Certifications:	FCC Class B, CE, UL, CB Scheme

**CP-3017-TR-US & -NA**

<b>NOVARA CP-3017-TR-US &amp; -NA ControlPads Specifications</b>	
Power Requirements:	<ul style="list-style-type: none"> <li>• CP-3017-TR-US: Min 136mA@12 <math>V_{DC}</math>, Max 450mA@12 <math>V_{DC}</math></li> <li>• CP-3017-NA: Min 141mA@12 <math>V_{DC}</math>, Max 450mA@12 <math>V_{DC}</math></li> <li>• Using a non-PoE power supply operates on voltages ranging from 9V to 16V continuously.</li> </ul>
Button Layout:	<ul style="list-style-type: none"> <li>• 17 red, green, and blue backlit buttons with programmable feedback</li> <li>• Pressable volume knob</li> <li>• Volume indicator</li> <li>• 5-button navigational pad (white backlighting only)</li> </ul>
Colors:	<ul style="list-style-type: none"> <li>• CP-3017-TR-US: Aluminum: FG1302-17-4-SA Black: FG1302-17-4-SB White: FG1302-17-4-SW</li> <li>• CP-3017-NA: Aluminum: FG1302-17-2-A Black: FG1302-17-2-B White: FG1302-17-2-W</li> </ul>
<b>Rear Panel Connectors</b>	
Power	One 2-pin Phoenix connector accepting 12 $V_{DC}$ power
Serial	Three 3-pin Phoenix connectors for RS-232 connections. Input voltage: <ul style="list-style-type: none"> <li>• <math>V_{IH} &gt; +2.7 V_{DC}</math>,</li> <li>• <math>V_{IL} &lt; -2.7 V_{DC}</math></li> </ul> Output voltage: <ul style="list-style-type: none"> <li>• <math>V_{OH} &gt; +5.0 V_{DC}</math> @ 35 mA maximum,</li> <li>• <math>V_{OL} &lt; -5.0 V_{DC}</math> @ 35 mA maximum</li> </ul>



NOVARA CP-3017-TR-US & -NA ControlPads Specifications (Cont.)	
IR	Two 2-pin Phoenix connectors for IR emitters. Supports generating carriers up to 1.142 MHz. Output only ports. Output voltage: <ul style="list-style-type: none"> <li>• <math>V_{OH} = +3.3 V_{DC} \pm 0.3 V_{DC}</math> @ 13 mA maximum</li> <li>• <math>V_{OL} = 0 V_{DC} \pm 0.3 V_{DC}</math> @ 13 mA maximum</li> </ul>
I/O	One 4-pin Phoenix connector for I/O connections. Supports sensing contact closure. Input voltage: <ul style="list-style-type: none"> <li>• HIGH (no contact closure): <math>V_{IH} &gt; 2.5 V_{DC}</math></li> <li>• LOW (contact closure): <math>V_{IL} &lt; 0.8 V_{DC}</math></li> </ul> Output voltage: <ul style="list-style-type: none"> <li>• <math>V_{OH} = +3.3 V_{DC} \pm 0.3 V_{DC}</math> (internal 25k Ohm pull-up resistor)</li> <li>• <math>V_{OL} = 0 V_{DC} \pm 0.3 V_{DC}</math> (200 mA maximum sink current)</li> </ul>
Relay	One 4-pin Phoenix connector for relay connections capable of switching $24 V_{DC}$ @ 1A maximum or $28V_{AC}$ @ 1A maximum
LAN	One RJ-45 connector for LAN connectivity.
Ethernet	One RJ-45 connector for LAN connectivity.
Reset	One pinhole pushbutton for factory reset ( <i>CP-3017-TR-US only, see FIG. 4 on page 12 for location of Reset button access</i> ).
Supported Baud Rates:	Up to 115200
Dimensions (HWD):	<ul style="list-style-type: none"> <li>• CP-3017-TR-US 17-button ControlPads (including knob): 4 11/16" x 8 1/4" x 1 3/4" (11.9 cm x 21.0 cm x 4.5 cm) Mounts into standard 4-gang US back boxes</li> <li>• CP-3017-NA 17-button ControlPads (including knob): CP-3017-NA: 4 11/16" x 6" x 1 3/4" (11.9 cm x 15.2 cm x 4.5 cm) Mounts into standard 2 gang US, UK, or EU back boxes.</li> </ul>
Weight:	<ul style="list-style-type: none"> <li>• CP-3017-TR-US: 0.588 lbs (0.267 kg)</li> <li>• CP-3017-NA: 0.863 lbs (0.392 kg)</li> </ul>
Operating Environment:	<ul style="list-style-type: none"> <li>• Storage temperature range: 14° - 140° F (-10° - 60° C)</li> <li>• Operating temperature range: 32° - 104° F (0° - 40° C)</li> <li>• Relative humidity: 5% to 85%, non-condensing</li> </ul>
Included Accessories:	<ul style="list-style-type: none"> <li>• Power Supply, 90-240VACIN, 12VOUT, 500mA (24-5791-SA)</li> <li>• Pre-printed labels (40-0087)</li> </ul>
Other AMX Equipment:	<ul style="list-style-type: none"> <li>• CP-RMS, RMS Gateway Module (<b>FG1310-01</b>)</li> <li>• CC-NIRC, NetLinX IR Emitter (<b>FG10-000-11</b>)</li> </ul>
Certifications:	FCC Class B, CE, UL, CB Scheme

## Mounting Specifications - 6-Button ControlPads

### CP-3006

CP-3006 6-button keypads mount onto standard 1 gang US, UK, or EU back boxes.

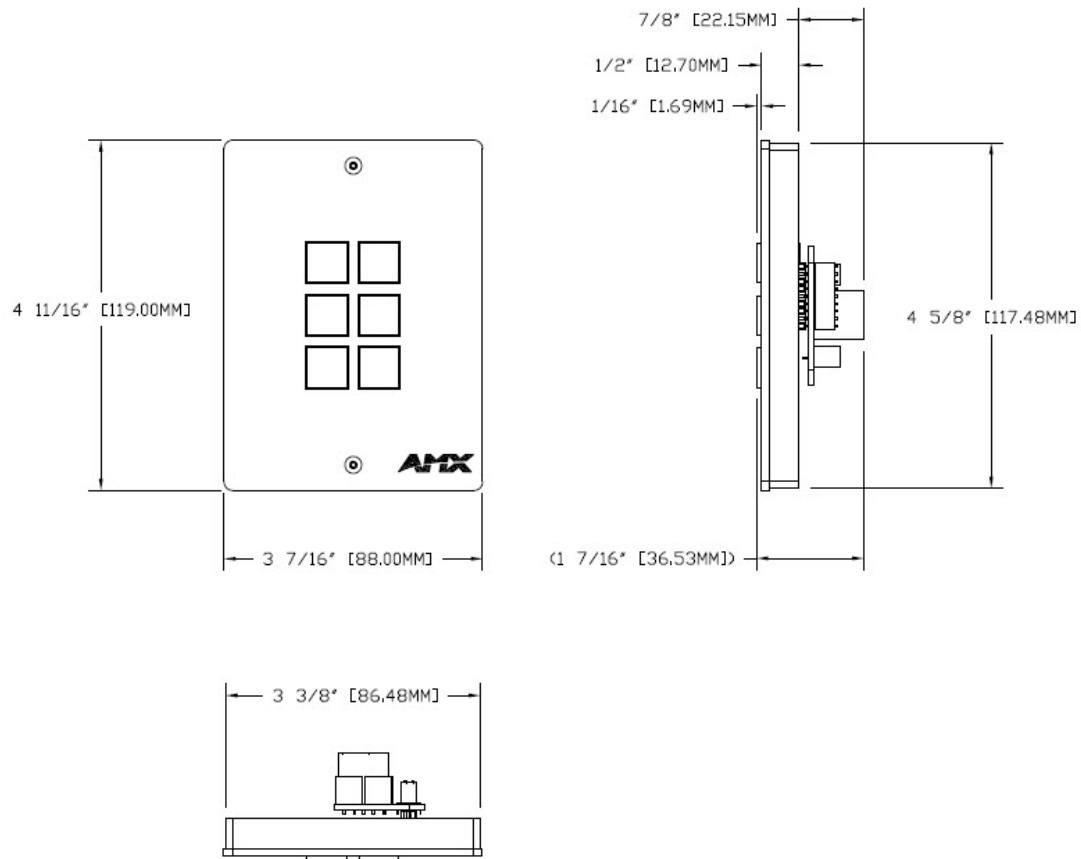
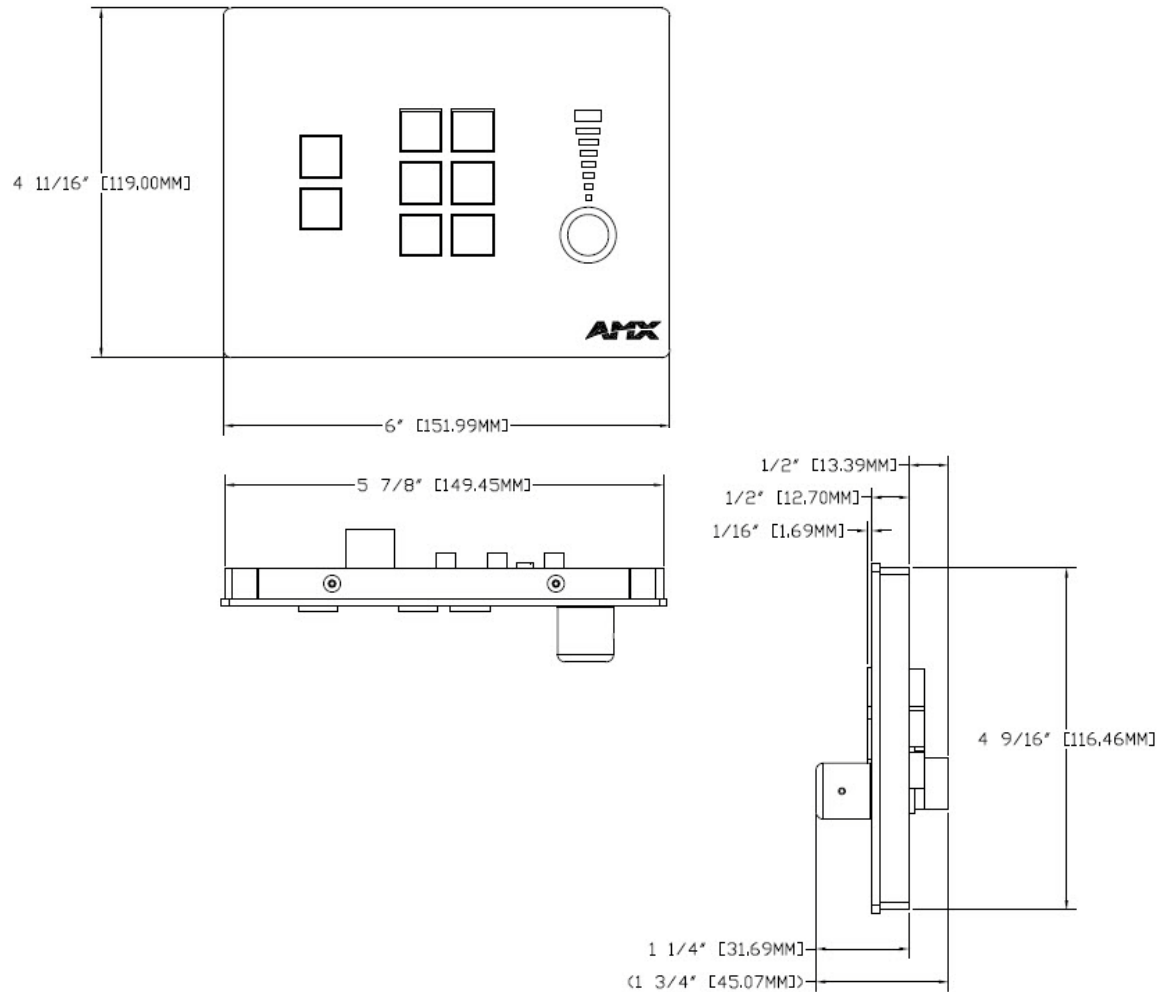

**FIG. 2** CP-3006 dimensions

## Mounting Specifications - 8-Button ControlPads

### CP-3008

CP-3008 8-button keypads mount onto standard 2 gang US, UK, or EU back boxes.

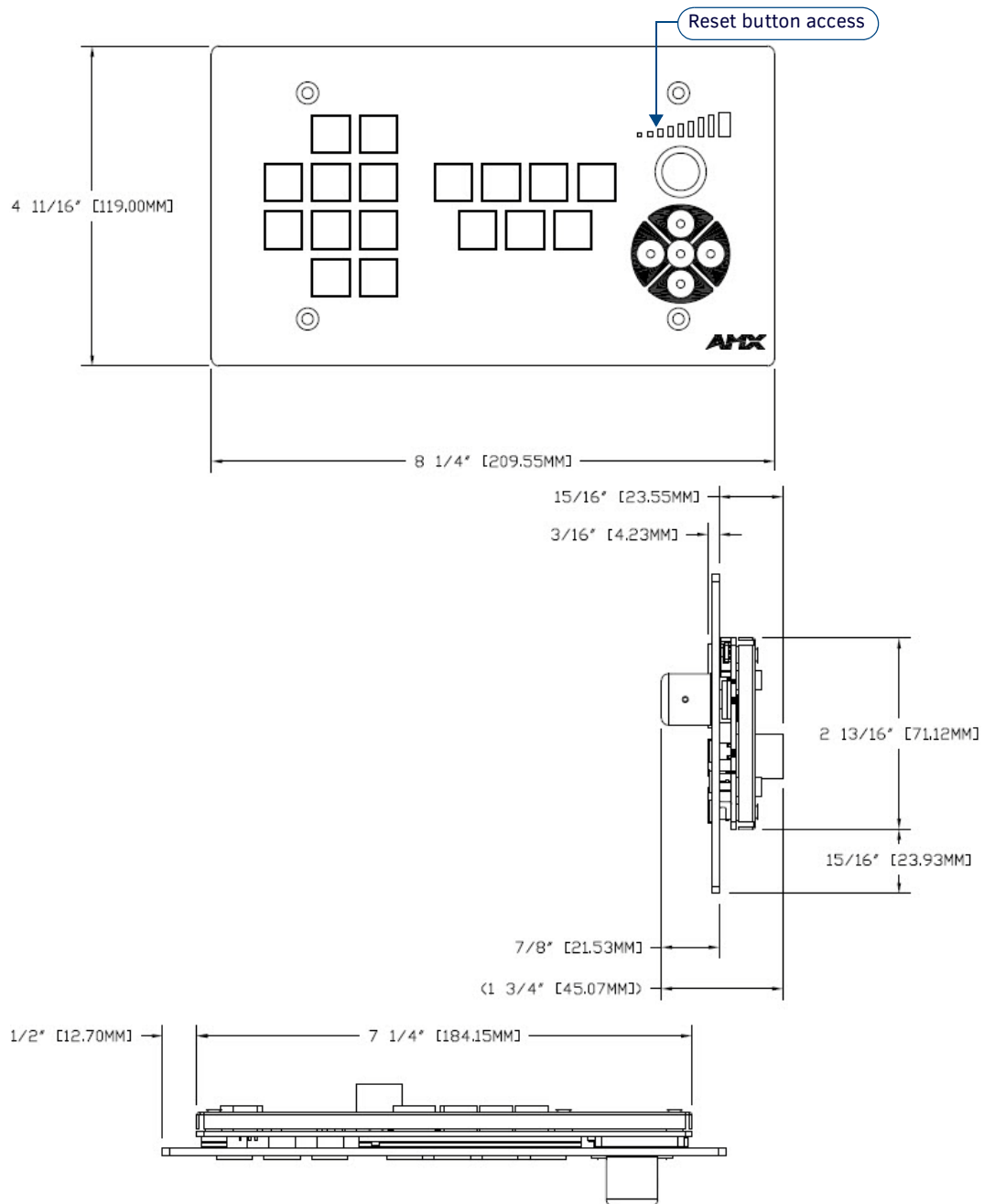

**FIG. 3** CP-3008 dimensions

## Mounting Specifications - 17-Button ControlPads

### CP-3017-TR-US

CP-3017-TR-US 17-button keypads mount onto standard 4 gang US back boxes.



**FIG. 4** CP-3017-TR-US dimensions

**CP-3017-NA**

CP-3017-NA 17-button keypads mount onto standard 2 gang US, UK, or EU back boxes.

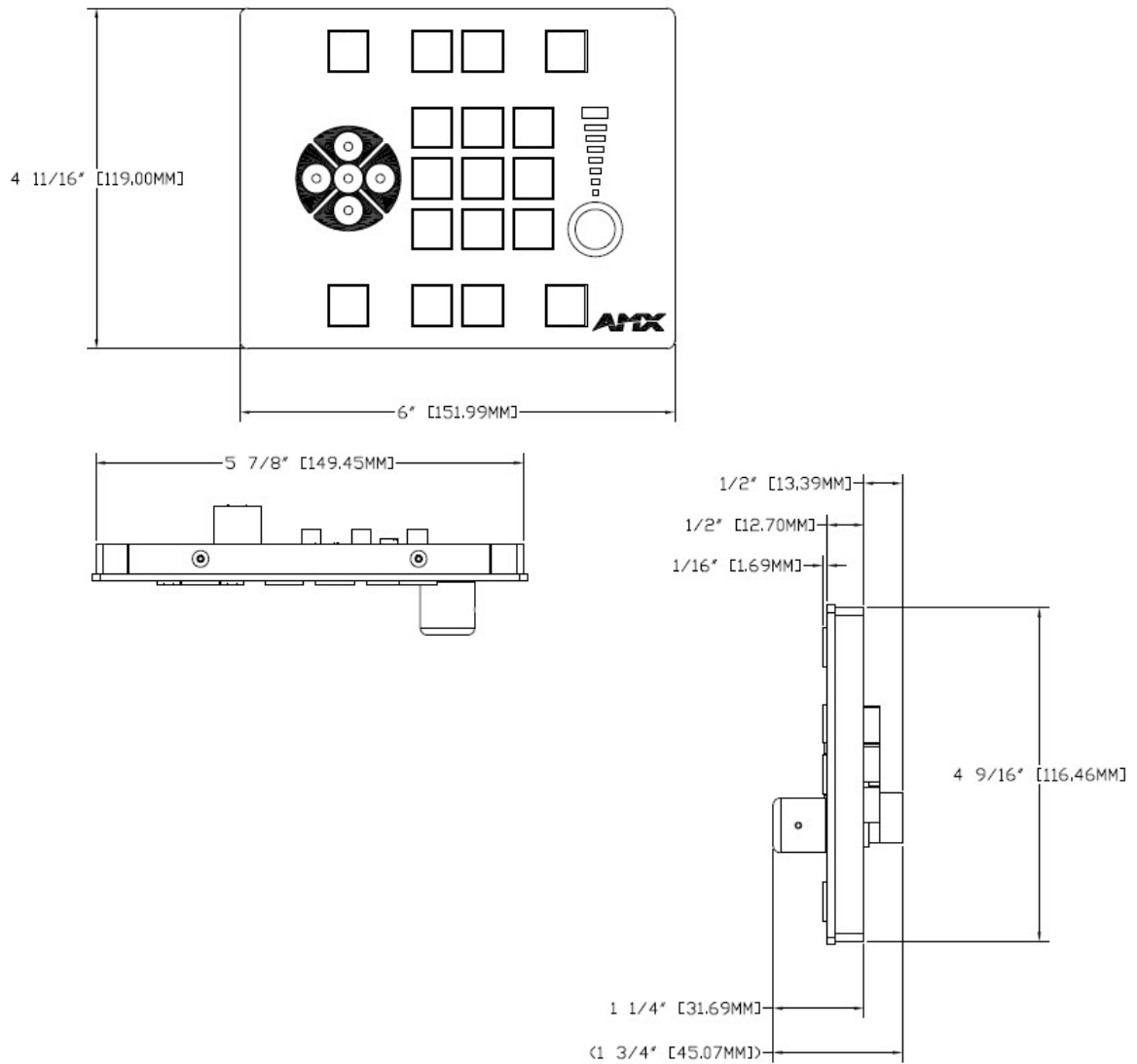

**FIG. 5** CP-3017-NA dimensions

## Button Layout

This section displays the button layout for each type of ControlPad.

### CP-3006

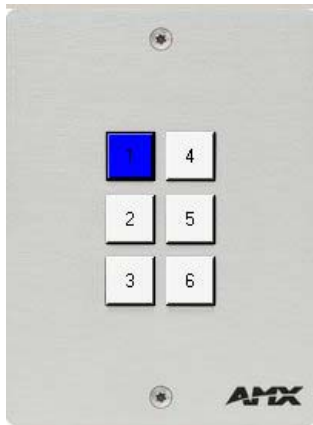

FIG. 6 CP-3006 button layout

### CP-3008

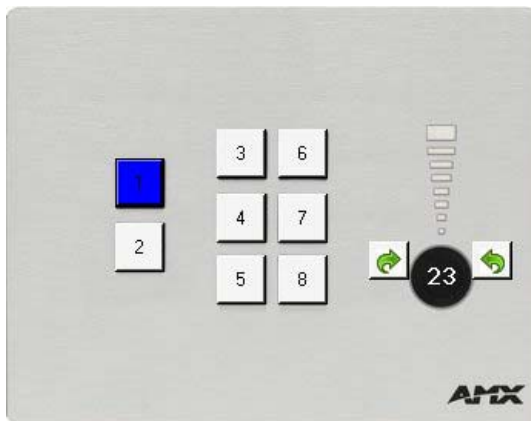

FIG. 7 CP-3008 button layout

### CP-3017-NA

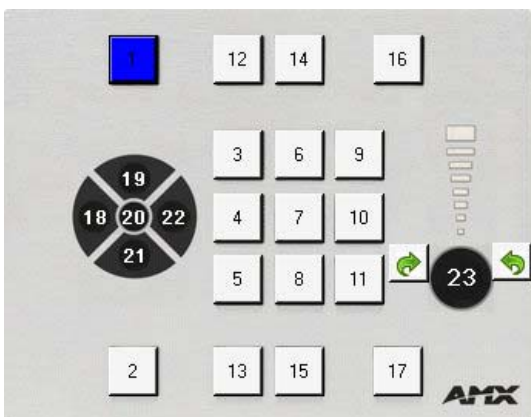
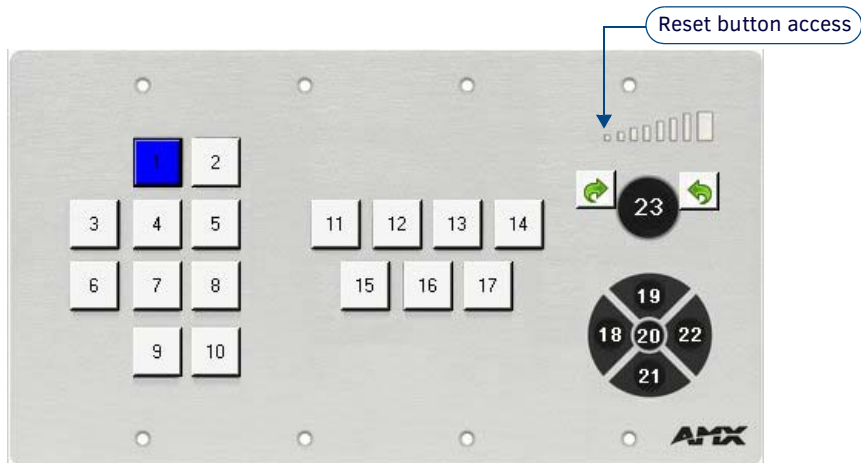

FIG. 8 CP-3017-NA button layout

**CP-3017-TR-US****FIG. 9** CP-3017-TR-US button layout

# Wiring and Device Connections

## Overview

This section describes the device connectors and ports available on each type of NOVARA 3000-series ControlPad. Here you can find wiring and electrical capacities for each type of connector. FIG. 10 displays the rear panel of the CP-3006:

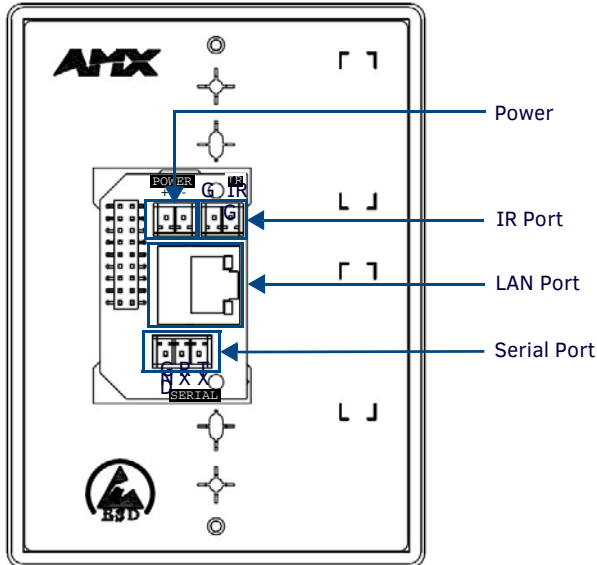

FIG. 10 CP-3006 rear panel

FIG. 11 displays the rear panel of the CP-3008:

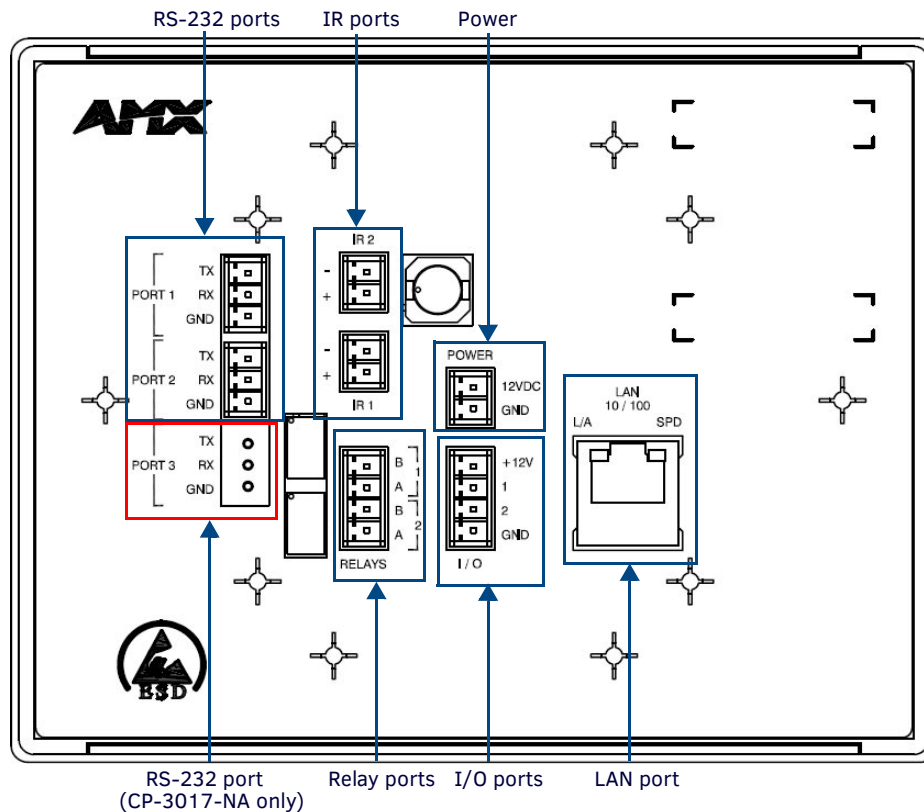

FIG. 11 CP-3008 rear panel

**NOTE:** The CP-3017-NA ControlPad has an identical rear panel layout as the CP-3008 except that the CP-3017-NA contains a third RS-232 port.



FIG. 12 displays the rear panel of the CP-3017-TR-US:

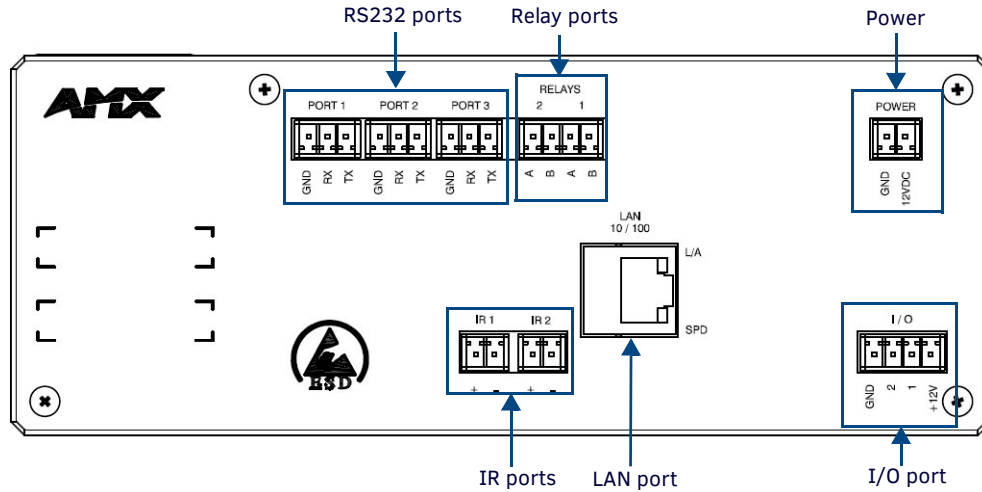

FIG. 12 CP-3017-TR-US rear panel

## Rear Panel Components

The following sub-sections describe each component on the rear panel of the 3000-series ControlPads. Refer to *Overview* section on page 16 for the component layout of the rear panels of each type of NOVARA 3000-series ControlPad.

### Power

The NOVARA 3000-series ControlPads features a 2-pin Phoenix connector accepting 12V<sub>DC</sub> power.

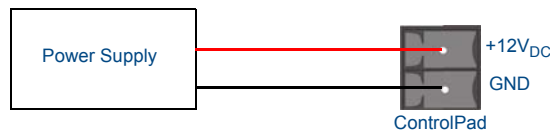

FIG. 13 Power Supply wiring

### RS-232

The NOVARA 3000-series ControlPads features up to two RS-232 connector ports so you can connect up to two serial devices to the ControlPad. The serial connectors comply with EIA-232-F signal levels. The RX line supports polling for RS-232 devices for statuses such as power status, input status, and lamp hours, so that this information can be provided to RMS.

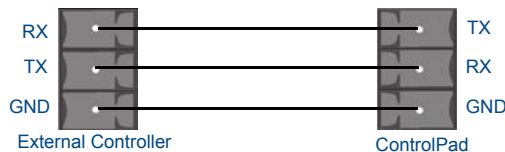

FIG. 14 Serial Connector wiring

Input voltage is as follows:

- $V_{IH} > +2.7 V_{DC}$
- $V_{IL} < -2.7 V_{DC}$

Output voltage is as follows:

- $V_{OH} > +5.0 V_{DC}$  @ 35 mA maximum
- $V_{OL} < -5.0 V_{DC}$  @ 35 mA maximum

## RELAYS

You can connect up to two independent external relay devices to the Relay connectors on the device. Connectors labeled **A** are for *Common* and **B** are for *Output* (FIG. 15).

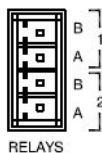
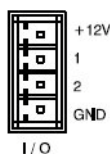

**FIG. 15** RELAYS connectors

- Each relay is isolated and normally open.
- 24 V<sub>DC</sub> @ 1 A maximum
- 28 V<sub>AC</sub> @ 1 A maximum

## I/O

The I/O port (FIG. 16) responds to switch closures and voltage level (high/low) changes, or can be used for logic-level outputs. The PWR pin provides +12 VDC @ 200 mA and is designed as a power output for the PCS Power Current Sensors, VSS2 Video Sync Sensors (or equivalent). The GND connector is a common ground and is shared by all I/O ports. A common ground is shared with I/O ports 1 - 2.



**FIG. 16** I/O connectors

Inputs are contact closure sensing. Input voltage is as follows:

- HIGH (no contact closure):  $V_{IH} > 2.5 V_{DC}$
- LOW (contact closure):  $V_{IL} < 0.8 V_{DC}$

Output voltage is as follows:

- $V_{OH} = +3.3 V_{DC} \pm 0.3 V_{DC}$  (internal 25k Ohm pull-up resistor)
- $V_{OL} = 0 V_{DC} \pm 0.3 V_{DC}$  (200 mA maximum sink current)

The following table provides wiring requirements for the I/O port:

I/O Port Wiring Specifications	
Signal	Function
+12 V:	PWR
1:	Output
2:	Output
GND:	Signal GND

## IR

You can connect up to two IR-controllable devices to the IR connectors (FIG. 17).

The IR connectors support generating carriers up to 1.142 MHz. The IR connectors accept an IR Emitter (CC-NIRC) that mounts onto the device's IR window, or a mini-plug (CC-NSER) that connects to the device's control jack.

You can also connect a data (0 - 5 V<sub>DC</sub>) device.

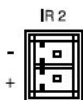

**FIG. 17** IR/SERIAL connectors

Output only port. Output voltage is as follows:

- $V_{OH} = +3.3 V_{DC} \pm 0.3 V_{DC} @ 13 \text{ mA maximum}$
- $V_{OL} = 0 V_{DC} \pm 0.3 V_{DC} @ 13 \text{ mA maximum}$

The IR/Serial connector wiring specifications are listed in the following table:

IR Connector Wiring Specifications (per Port)		
IR connections	Signal	Function
1	GND (-) Signal 1 (+)	Signal GND IR data
2	GND (-) Signal 2 (+)	Signal GND IR data

**NOTE:** Do NOT connect a power connector to either IR port. Doing so may damage the ControlPad.

### LAN (RJ-45)

The LAN RJ-45 port provides 10/100 Mbps communication via Cat5/5e/6 network cable. The LAN port automatically negotiates the connection speed (10 Mbps or 100 Mbps), and whether to use half duplex or full duplex mode. The LAN port is best used for connecting to a network switch.

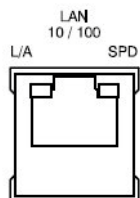

FIG. 18 LAN port

FIG. 19 provides the pinouts and signals for the LAN connector and cable.

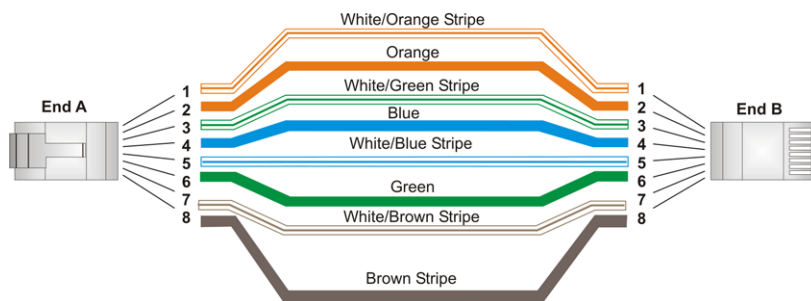

FIG. 19 RJ-45 wiring diagram

**NOTE:** If Ethernet connectivity is lost on any keypad, and then re-established, connectivity may take some time to resume. You will be unable to program the keypad until it is fully online.

## Resetting the ControlPad

Each ControlPad features a pinhole Reset pushbutton on the rear on the unit for factory reset. To reset the ControlPad, press and hold in the Reset pushbutton for 10 seconds, then release it. The ControlPad will reset. During factory reset, the backlight turns off for all buttons, but all buttons should be back online after 1-2 minutes. If you do not hold in the reset button for the full 10 seconds, the reset does not occur. (There is no soft reboot with the Reset button, but you can perform a soft reboot from the web pages.)

**NOTE:** When you reset a ControlPad, the ControlPad is restored to the factory default, so you will lose any scripts, IRL files, Device Interrogation settings, or RMS server information loaded on the system.

## CP-RC01 IR Remote

The CP-RC01 IR Remote (FG1302-70) (FIG. 1) provides local control of CP-3008 and CP-3017 series ControlPads.



FIG. 20 CP-RC01 IR Remote

### Product Specifications

CP-RC01 IR Remote	
Dimensions (HWD):	8" x 2" x 1" (20 cm x 5.5 cm x 2.8 cm)
Weight:	Without batteries: 0.208 lbs (94.34g)
Battery:	2 AAA Batteries
Power Consumption:	Approximately 50mA at IR transmit
IR Transmit Frequency:	38 KHz
Range:	20-30ft (6-9m) Standard <i>Note: Range can be affected by factors such as angle of incidence and LED graph brightness.</i>
Operating Environment:	<ul style="list-style-type: none"> <li>Storage temperature range: -40° - 158° F (-40° - 70° C)</li> <li>Operating temperature range: 41° - 104° F (5° - 40° C)</li> <li>Relative humidity: 10% to 90%, non-condensing</li> </ul>

### Button Functions

You can create a CP-3000 script for each button on the remote to perform a specific task when pressed. The buttons can be programmed by using AMX DCS software to program a virtual button. Each button has a corresponding IR remote code. See the *IR Remote Codes* section for a list of IR remote codes.

To program a button function, write a script for a virtual button numbered with the corresponding IR remote code for the button on the remote plus 100. For example, if you want to program the Power button on the remote, you should write a script for virtual button 109 (9+100). Select the virtual button from the Button Num menu in the Button Event area of the AMX DCS window.

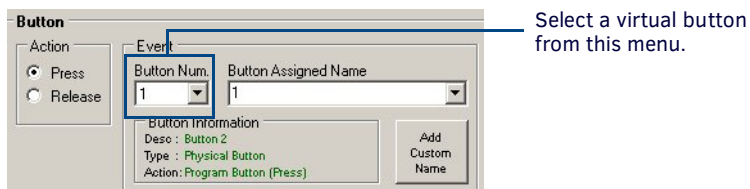

FIG. 21 Button Event area of the AMX DCS window

For more information about scripting and using AMX DCS, see the *Device Configuration Software* section on page 28.

## IR Remote Codes

The following table lists the IR codes for the CP-RC01 remote.

IR Remote Codes			
Button	Code	Button	Code
Mute	26	Record	8
Power	9	Pause	2
PC	30	Stop	3
STB	31	Volume Up	24
Disc	32	Volume Down	25
Aux	33	Page Up	106
Red	71	Page Down	107
Green	72	Channel Up	22
Yellow	73	Channel Down	23
Blue	74	1	11
Exit	50	2	12
Info	101	3	13
Up	45	4	14
Down	46	5	15
Left	47	6	16
Right	48	7	17
OK	49	8	18
Guide	105	9	19
Menu	44	0	10
Rewind	5	Subtitle	100
Play	1	Prev	81
Fast Forward	4		

## PS-PoE-EX0.9 PoE Extractor

The PS-PoE-EX0.9 PoE Extractor (FG423-85) (FIG. 22) is a power extractor module that delivers regulated DC power for any secondary device that is not Power-over-Ethernet (PoE) capable. It allows multiple PoE devices to run over a single power over Ethernet.

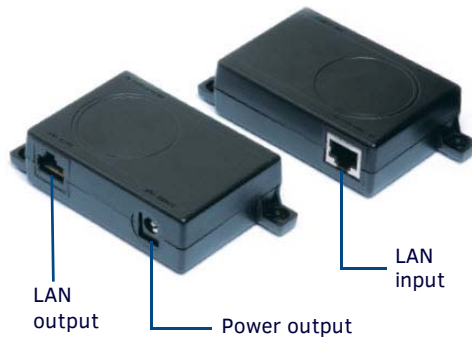

**FIG. 22** PS-PoE-EX0.9 PoE Extractor

### Product Specifications

PS-PoE-EX0.9 PoE Extractor	
Input Connector:	Standard LAN connector
Output:	
Output Voltage:	12V <sub>DC</sub>
Output Current:	0.9A
Output Power:	10.8W
Line and Load Voltage Regulation:	+/-1% V-out
Efficiency:	88% min.
Transient Response:	1% of V-out (50%-100% load deviation)
Overvoltage Protection:	Transorb protected
Output Connection:	Standard
Output Noise:	1% of V-out, 20MHz BW
Input:	
Input:	36-57 V <sub>DC</sub>
Input Current Overload Protection:	When I <sub>in</sub> > 450mA for 75mSec, input latches off
Input Surge:	Transorb protected
Input Undervoltage:	<ul style="list-style-type: none"> <li>• Turn on: 33-42 V<sub>DC</sub></li> <li>• Turn off: 30-34 V<sub>DC</sub></li> </ul>
General:	
Switching Frequency:	200kHz +/- 1%
Recovery Time:	100Usec to 1% V-out (SR= 1a/10Usec)
I-overload:	120% ± 5%
Short Circuit:	Auto recovery when short is removed
Thermal Shutdown:	Internally protected against over-temp conditions.
Operating Temperature:	<ul style="list-style-type: none"> <li>• Storage temperature range: -40° - 185° F (-40° - 85° C)</li> <li>• Operating temperature range: -40° - 140° F (-40° - 60° C)</li> </ul>
Dimensions (LWH):	3" x 2 1/8" x 1" (7 5/8 cm x 5 1/3 cm x 2 1/2 cm)
Weight:	58 g (205 oz.)
Certifications:	RoHS

## Connection

The PS-PoE-EX0.9 PoE Extractor converts a LAN connector PoE source into a data-only LAN output and a voltage-only output via a standard DC connector. Use standard Cat5 cables and the provided power connector to connect the PoE Extractor to your ControlPad.

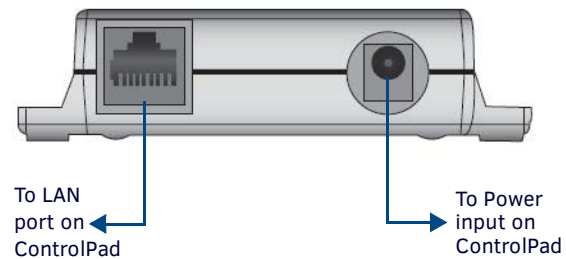

**FIG. 23** PoE Extractor outputs

The following steps describe how to connect the PoE Extractor to your ControlPad.

1. Connect a Cat5 cable from a PoE source to the LAN input on the PoE extractor.
2. Connect a Cat5 cable from the LAN output on the PoE extractor to an LAN port on the ControlPad.

**NOTE:** *The PS-PoE-EX0.9 PoE Extractor uses standard Cat5 cabling.*

3. Use the provided cable to connect the power supply from the power output on the PoE extractor to the power input on the ControlPad.

## Power Cable Wiring

The PS-PoE-EX0.9 Extractor features a 72-inch (82 7/8cm) 2-pin Phoenix connector outputs 12VDC power to a 2.5 x 5.5mm barrel connector. FIG. 24 illustrates the wiring for the power cable:

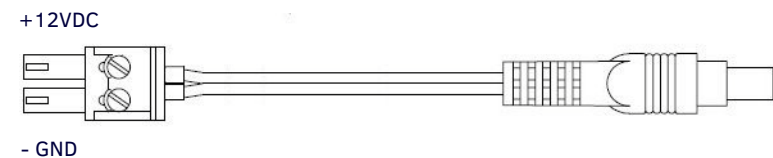
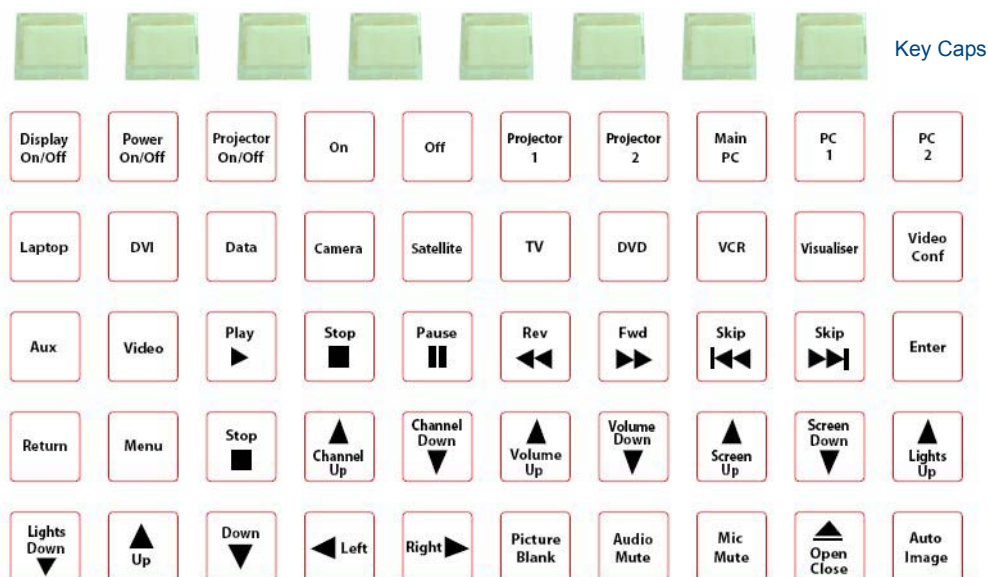

**FIG. 24** PS-PoE-EX0.9 Extractor wiring diagram

# Button Labeling

## Overview

NOVARA ControlPads and KeyPads come with a set of clear plastic Key Caps, which are designed to fit tightly over the pushbuttons, and allow you to place a label on each button according to the requirements of your particular installation. NOVARA ControlPads and KeyPads also come with a pre-printed acetate sheet with a range of 50 (pre-cut) button label inserts. The button labels provided will accommodate most installations, but it is also possible to print your own button labels on acetate for custom button labeling.



Acetate sheet of 50 standard Button Labels (pre-cut)

**FIG. 25** Acetate Button Labels and plastic Key Caps

### Installing Acetate Button Labels and Key Caps - READ THIS FIRST!

1. Punch out the desired Button Label from the included acetate sheet.
  - If you have printed your own custom button labels on acetate, cut each button label to fit inside the Key Caps.
    - Custom button labels must be cut to a **1.14cm (0.45") square** to fit securely inside the Key Caps.
    - The thickness of the acetate used must not exceed **.004" (0.10 mm)**.
2. Place the Key Cap face-down, and insert the Button Label into the bottom of the Key Cap (FIG. 26).

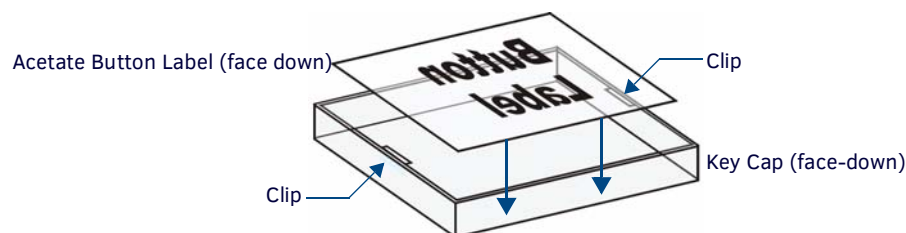

**FIG. 26** Placing a Button Label inside a Key Cap

- Orient the Button Label inside the Key Cap so that the two clips are located on the left and right sides of the readable text on the Button Label, as indicated in FIG. 26.
  - Be sure to place the Button Label face-down inside the Key Cap (see FIG. 26), otherwise the label will be seen in reverse once the Key Cap is installed.
3. Install the Key Cap on the pushbutton (FIG. 27):



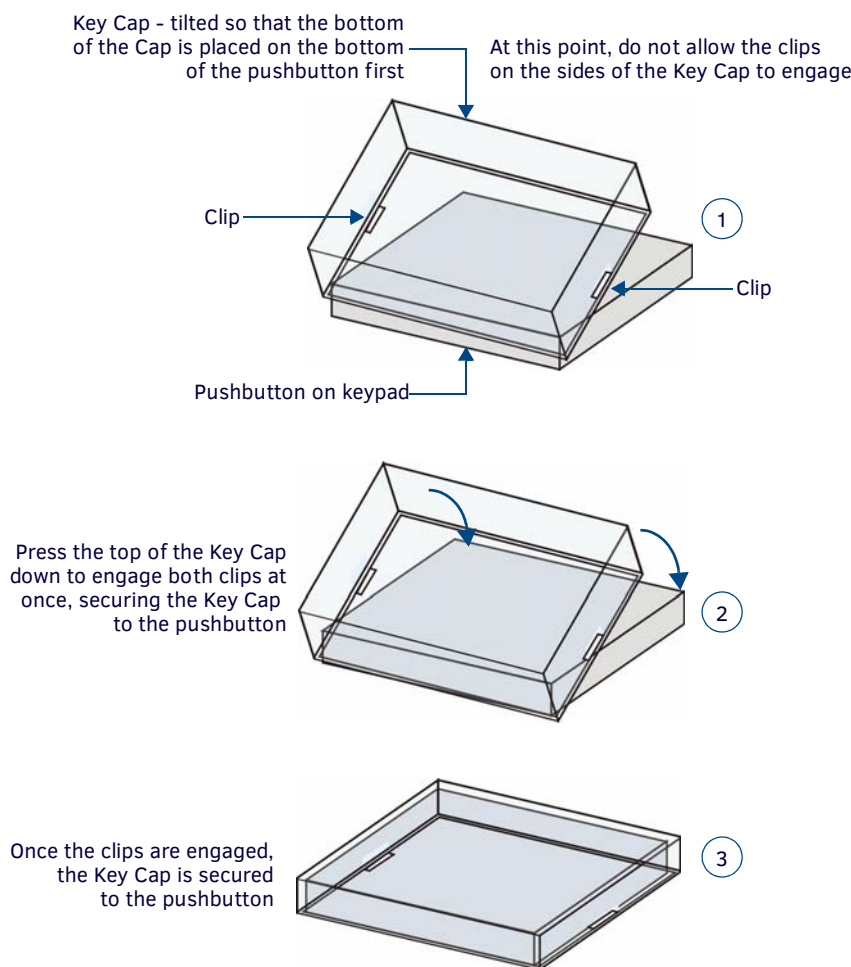

**FIG. 27** Placing a Button Label inside a Key Cap

**NOTE:** Verify that the vertical orientation of the Button Label is correct relative to the keypad.

- Gently press the bottom of the Key Cap (no clip) onto the pushbutton. Do not allow the clips on either side to engage.
- With the bottom of the Key Cap secured, gently press the top of the Key Cap. This action will engage both clips simultaneously, and the Key Cap will snap into place on the push button.

**NOTE:** Be careful to follow these procedures closely - the bottom of the Key Cap must be installed on the pushbutton before the Key Cap clips engage, or there is a risk of the button being misaligned. Also note that removing the Key Caps requires additional steps - see the Removing/Replacing Button Labels section on page 25 for details.

## Removing/Replacing Button Labels

The button labels on NOVARA keypads are acetate inserts that fit inside the Key Caps installed on the pushbuttons. In order to change the inserts, the key caps need to be removed. Removing the Key Caps on NOVARA keypads requires disassembling the keypad, so that they can be accessed through the rear of the faceplate:

### Disassembling the NOVARA ControlPad

**NOTE:** Remove power from the NOVARA keypad, and discharge any static electricity from your body by touching a grounded metal object before performing the following steps.

This procedure requires a Phillips-head screwdriver and a .050" hex driver. This procedure is not necessary with CP-3006 ControlPads.

- Loosen the knob from the faceplate by using a .050" hex driver in the hole in the side of the knob.
- Remove the volume knob by unscrewing it from the faceplate.
- Lift the faceplate away from the rear panel to expose the buttons and circuit board.

### Replacing Key Caps / Button Labels

Once the lower board has been removed, you have full access to the pushbuttons.

- Insert the acetate Button Label in each Key Cap. Be sure to place the Button Label face-down inside the Key Cap, otherwise the label will be seen in reverse once the Key Cap is installed.
- Gently replace the Key Cap on the pushbutton:

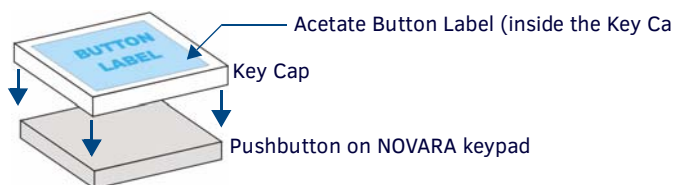

**FIG. 28** Placing a Button Label inside a Key Cap

- Verify that the vertical orientation of the Button Label is correct relative to the NOVARA keypad.
- Align the Key Cap with the target pushbutton, and gently push the Key Cap down over the pushbutton.
- Once seated properly on the pushbutton, the Key Cap will snap into place.

### Re-Assembling the ControlPad

Follow these steps to re-assemble the keypad.

1. With all button Key Caps in place, put the faceplate over the circuit board.
2. Use the supplied #6 screws to secure the faceplate to the circuit board. There are two screw holes on the top of the faceplate rim, and two on the bottom. Use either the Torx screws or #4 Phillips-head screws to attach the faceplate. Use a Torx driver with a T8 tip for the Torx screws; use a Phillips-head screwdriver for the Phillips-head screws. For CP-3006 and CP-3017-TR-US ControlPads, the screws attach through the holes in the faceplate. See the *CP-3008 Reassembly* section on page 26, the *CP-3017-NA Reassembly* section on page 27, and the *CP-3017-TR-US Reassembly* section on page 27 for visual demonstrations of how to reassemble each type of ControlPad.
3. Reattach the knob to the faceplate and screw it in as far as it can go. You should be able to press the knob as a button for extra functionality.
4. Tighten the knob in place using a .050" hex driver in the hole in the side of the knob.

Steps 3 and 4 do not apply to CP-3006 ControlPads.

### CP-3008 Reassembly

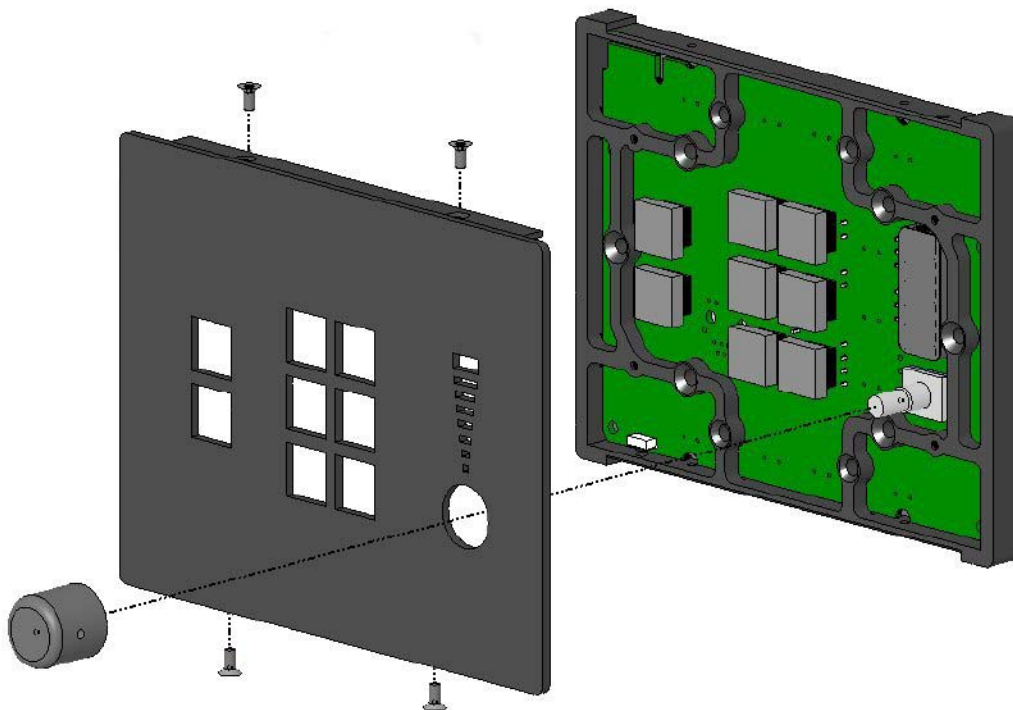

**FIG. 29** CP-3008 reassembly

### CP-3017-NA Reassembly

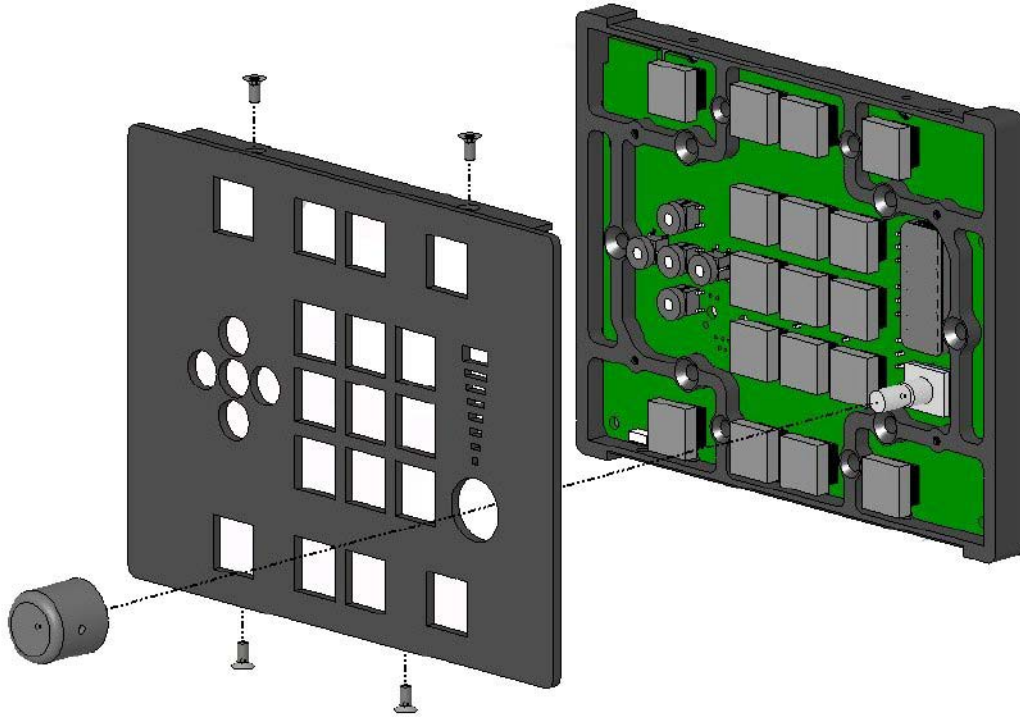

**FIG. 30** Reassembling a CP-3017-NA ControlPad

### CP-3017-TR-US Reassembly

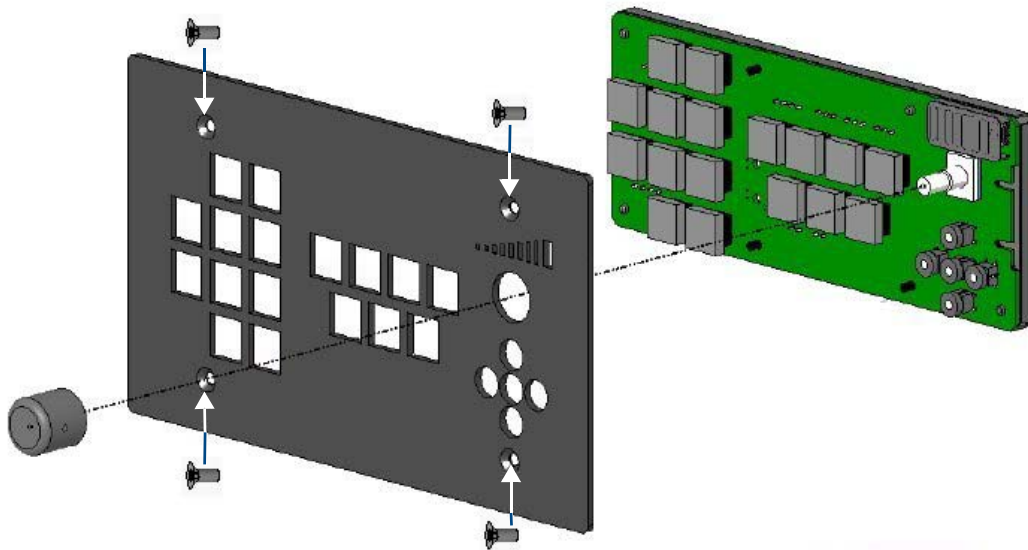

**FIG. 31** CP-3017-TR-US reassembly

# Device Configuration Software

## Overview

You can configure Novara ControlPads and KeyPads using the *AMX DCS* software application, available for download from [www.amx.com](http://www.amx.com) (FIG. 32).

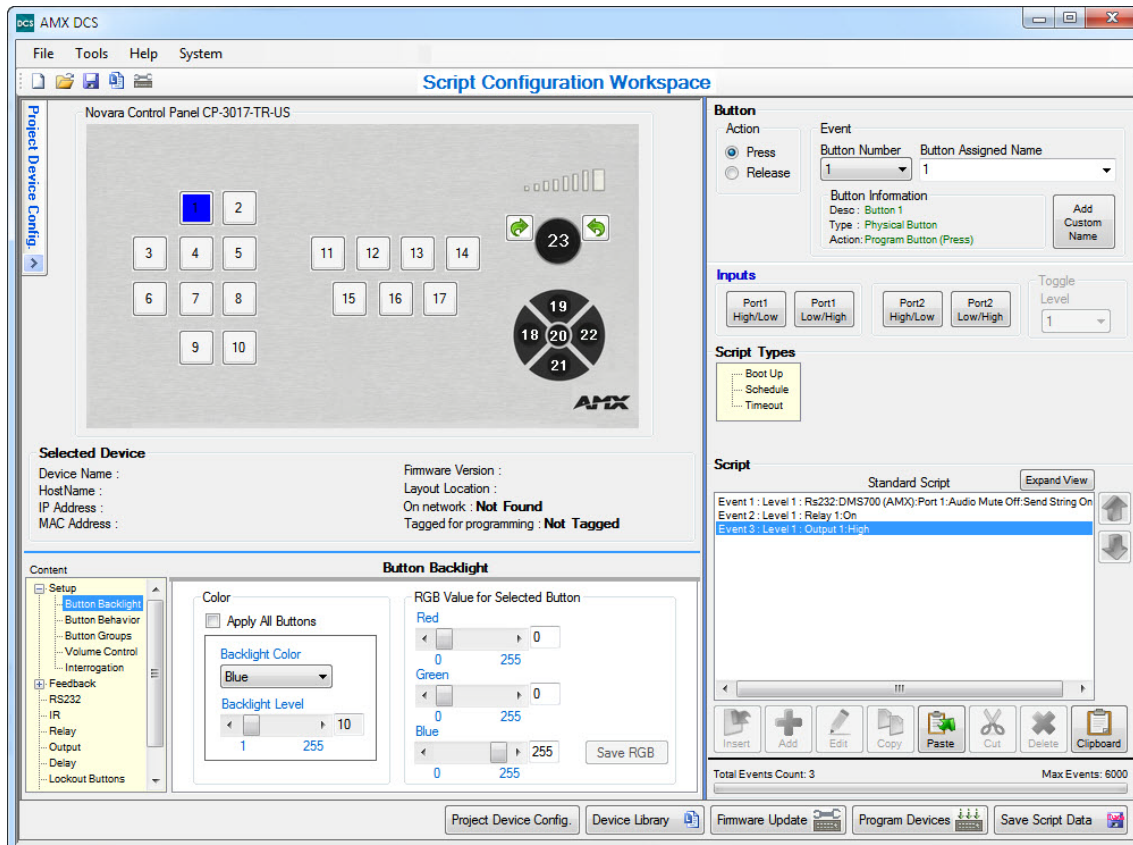

FIG. 32 AMX DCS Main screen

The *AMX DCS* application allows the ControlPad to perform various functions such as RS232/IR control, button feedback, delay time, and relay control.

- Each button is configured individually, and can execute on a Press or Release.
- A Script is written for each button containing events. A script can be written for events to execute when the ControlPad is powered up by selecting 'Start Up' from the system window.
- An Event can be an RS232 command, a button Feedback, a Delay Time, etc.
- When any or all of the buttons have been configured, the information can be uploaded to the ControlPad.

The *AMX DCS* application is compatible with the following operating systems:

- Windows XP (32-bit) (US English)
- Windows 7 (32-bit) (US English)
- Windows 7 (32-bit) (Chinese)
- Windows 7 (32-bit) (German)
- Windows 7 (32-bit) (Japanese)
- Windows 7 (32-bit) (Arabic)
- Windows 7 (64-bit) (US English)
- Windows 7 (64-bit) (Chinese)
- Windows 7 (64-bit) (German)
- Windows 7 (64-bit) (Japanese)
- Windows 7 (64-bit) (Arabic)

**NOTE:** You may experience scaling issues with the *AMX DCS* user interface if you use Large or Extra Large fonts with a low resolution display. Adjusting your resolution to a standard DPI setting should resolve these issues.

## Setting Your Bonjour Preference

Bonjour is a zero-configuration networking client that allows you to detect the IP addresses of any ControlPads on a local area network. In essence, it allows you to set up a network without any configuration. Bonjour is free, and widely available for download. Each time you open DCS, it detects whether you have Bonjour installed, and if DCS cannot find Bonjour on your PC, you receive the option to download Bonjour (FIG. 33).



**FIG. 33** Download Apple's Bonjour DLL dialog

Selecting Yes closes DCS, opens your default web browser, and takes you to the Bonjour website so you can download and install the software. If you do not want to use Bonjour to detect your ControlPads, you can disable Bonjour. Disabling Bonjour before installing it also stops the prompts asking you to install it whenever you open DCS. Perform these steps to set your Bonjour preference:

1. From the Tools menu, select **Bonjour Preference**. The *Bonjour Preference* dialog opens (FIG. 34).

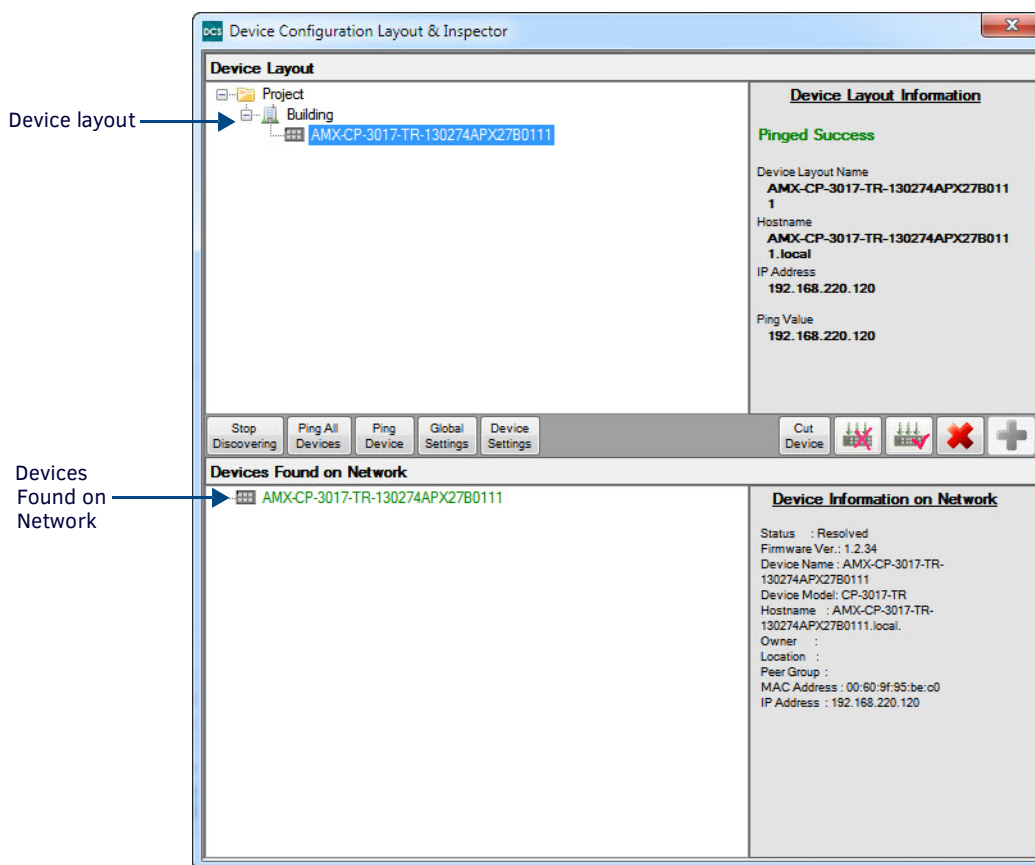

**FIG. 34** Bonjour Preference dialog

2. Select **Enable Bonjour** or **Disable Bonjour** depending on the option you want.
3. Click **OK**.

## Project Device Configuration

The project device configuration establishes the layout of all devices in the system. When you open an existing project device configuration, AMX DCS detects all devices on the network. Any devices found appear in the Devices Found on Network area. You can use these devices to create a layout of devices, separating each by project or location. You can create your device layout in the Device Configuration Layout & Inspector window (FIG. 35).







**FIG. 35** Device Configuration Layout & Inspector window

The Device Configuration Layout & Inspector window is divided into two sections: the Device layout and the Devices Found on Network list. The device layout displays your device layout and is broken up into the three nodes: main project, location, and device. The Devices Found on Network list displays all available ControlPads that are not bound to another system or project. These devices are available for you to use in your device layout.

Device Configuration Layout & Inspector Window Options	
Device Layout	The device layout is broken up into three nodes. The top node is the main project, the 2nd node defines the location, and the 3rd node defines the device.
Discover Devices/ Stop Discovering	Click to search for any ControlPads currently on the network and display them in the Devices Found on Network list. When you click Discover Devices, DCS continuously searches for new devices on your network. While this is happening, the button label changes to Stop Discovering. Click Stop Discovering to have DCS stop detecting devices. This option is not available if you disable Bonjour.
Ping All Devices	Click to ping all devices in the current Device Layout. If the device is successfully pinged, the device appears in black in the Device Layout. If undetected, it appears in red.
Ping Device	Click to ping the selected device. If the device is successfully pinged, the device appears in black in the Device Layout. If undetected, it appears in red.
Global Settings	Click to view the global settings for Network, DNS, and other connected services. This button only appears after you add a project to the device layout.
Device Settings	Click to view the Network, Device Info, DNS, and Connection settings for a device. At the device level, you can set individual settings for a single device or use the global device settings set for the project. This button only appears when you select a device in the device layout.
Cut Device	Click to remove a node from the device layout and save it to memory. Next, you can use the Paste Device option to place the node into another location in the device layout.
Paste Device	Click to place a node that is saved to memory via Cut Device into another location in the device layout.



Device Configuration Layout & Inspector Window Options (Cont.)	
Untag Device	 To untag a device, select it then click the Untag button. Selecting a Project or Location then clicking the Untag button shall untag all sub-devices.
Tag Device	 A tagged device can be programmed or receive a firmware upgrade. Any firmware upgrades or device programming you perform in the AMX DCS window only apply to the tagged devices in the Project Device Configuration. Select a device then click the Tag button to tag the device. Selecting a Project or Location then clicking the Tag button tags all sub-devices.
Delete	 Highlight a node and click the Delete button to remove the node from the Device Layout. Deleting a project or location also removes all its sub-nodes.
Add	 Add locations to help organize the device layout in your project. Click the Add button to open the Select Item to Add window. You can add a Building, House, Classroom/Room, or Device. You can also add sub-locations to any location.
Devices Found on Network	Displays a listing of all available ControlPads on your network that are not in your project. The status of each ControlPad is noted by color, and if you pass your mouse pointer over a device, a pop-up text indicating the status of the device appears. <ul style="list-style-type: none"> <li>• Black text indicates the ControlPad is not yet resolved, and it may nor may not be online in the subnet.</li> <li>• Red text indicates that DCS cannot find this device on the subnet.</li> <li>• Green text indicates that DCS found the device on the subnet, and you can add it to your project.</li> </ul> You can click and drag a device from this section to the device layout to add it to your project.

### Modifying a ControlPad in the Device Layout

The Device Layout is an area on the Device Configuration Layout & Inspector window in which you can set up and organize all ControlPads in your configuration. You can modify a device's name or change its IP address or hostname by right-clicking the device in the Device Layout tree. Doing so opens the Modify Device Layout Information window.

**NOTE:** If you are configuring your ControlPads while they are off your network, you should manually configure static IP addresses for the ControlPads in the Device Info section of the Configure Device Settings window. See the Configuring Device Settings section on page 34 for more information.

Perform these steps to modify a ControlPad in the device layout:

1. Add a device to your project.
2. In the Device Layout tree, right-click the ControlPad you want to modify. The Modify Device Layout Information window opens (FIG. 36).

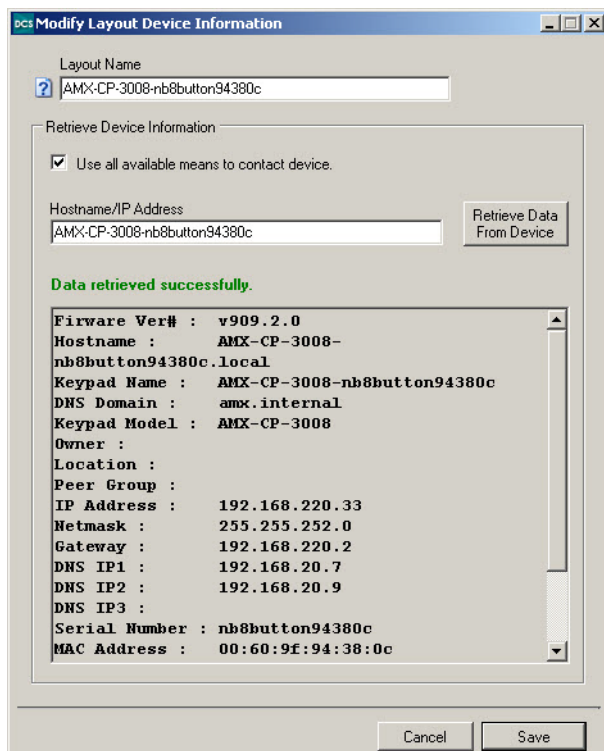

FIG. 36 Modify Layout Device Information window

3. Enter the name for the ControlPad in the Layout Name field.

**NOTE:** If you have a CP-3006 with a serial number (located under the barcode) of 123456APX78A0001, the hostname and the device name that will be used by its Bonjour beacon will be AMX-CP-3006-123456APX78A0001. For models with a designation such as CP-3017-TR, the hostname will include the -TR (e.g. AMX-CP-3017-TR-123456APX78A0001).

4. Enter the IP address or hostname of the ControlPad in the Hostname/IP Address field.
5. Click **Retrieve Data from Device** to ping the ControlPad and retrieve information about it.
6. Click **Save** to save the changes and close the window.

**NOTE:** Whenever you retrieve settings from a ControlPad, and you add or save the changes to the layout, the changes not only override the currently saved settings for the ControlPad, but also unchecks the Use Project Global Default Settings check boxes on the Configure Device Settings window. You must re-edit the ControlPad, and recheck these boxes if you want to override the recently saved settings.

### Creating a New Project

Add a Project node to an empty device layout by clicking the Add button. The project node automatically appears and you can rename the project to anything you like. After naming the project, you can configure the global settings for the project. See the *Configuring Global Settings* section on page 33 for more information.

Clicking the Add button again enables you to add a location node to the project. After you create a project, you can drag any device in the Devices Found on Network area to the project or location. The device will appear beneath the project or location to which you drag it. You can only add a device to a single project. Once you add a device to a project, the device is bound and any attempt to drag it to another project or location results in an error.

### Adding a Node to the Device Layout

Add a Project node to an empty device layout by clicking the Add button. The project node automatically appears and you can rename the project to anything you like. After naming the project, you can configure the global settings for the project. See the *Configuring Global Settings* section on page 33 for more information.

### Renaming Tree Nodes

You can rename Project and Location nodes by clicking the nodes twice (once for selection and again to rename). You must assign a unique name to each node. To rename a device, you must change it through the Device settings. Perform these steps to rename a device in your device layout:

1. Add a device to your project.
2. Select the device in the device layout, and click **Device Settings**. The Configure Device Settings window opens (FIG. 39).
3. Click **Device Info** in the Content area to display the Device Information options.
4. Enter the device name in the **New Device Name** field. You can also provide information in the Host Name, Owner, and Location fields if you want.
5. Click **Accept**. The new device name appears in the device layout.

### Relocating Tree Nodes

Location and Device nodes can be relocated to applicable area by clicking and dragging the node to its new location within the project. Moving a node also moves its sub-nodes. No node can be added or moved under a device. Project nodes cannot be relocated and must remain on top of the tree.

### Tagging Devices

A tagged device can be programmed or receive a firmware upgrade. Any firmware upgrades or device programming you perform in the AMX DCS window only apply to the tagged devices in the Project Device Configuration.

Select a device then click the Tag button to tag the device. Selecting a Project or Location then clicking the Tag button shall tag all sub-devices.

To untag a device, select it then click the Untag button. Selecting a Project or Location then clicking the Untag button shall untag all sub-devices.

When a device is not found on the network, the text label appears bolded red. You cannot tag these devices.

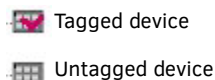

**FIG. 37** Configure Global Device Settings Window (Network options)



## Configuring Global Settings

At the project level, you can set global settings for all devices on the project. Click the Global Settings button to access the Configure Global Device Settings window (FIG. 38). The window contains five separate screens with settings for Network, DNS, Connections, NTP, and Web. Click the option you want in the Content area to view or change the settings for each type.

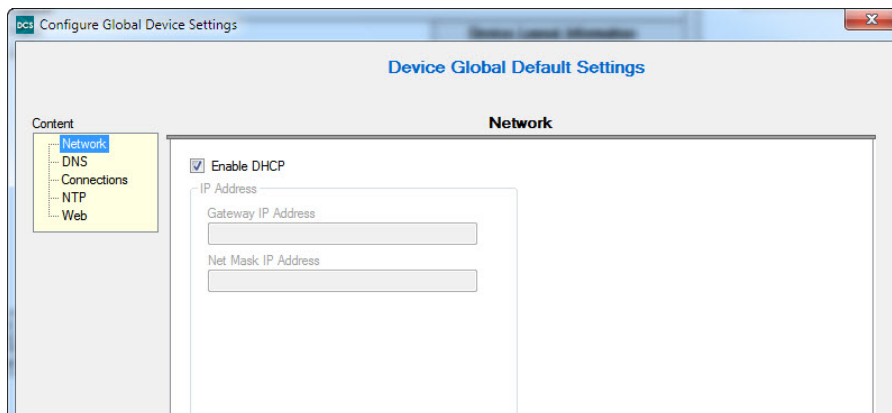

FIG. 38 Configure Global Device Settings Window (Network options)

The following table lists the options for each section of the Configure Global Device Settings window:

Configure Global Device Settings Window Options	
<b>Network</b>	
Enable DHCP	Enables DHCP on all devices when checked. This option is checked by default. This option is checked by default. If you disable this option, you should manually configure static IP addresses for the ControlPads in the Device Info section of the Configure Device Settings window. See the <i>Configuring Device Settings</i> section on page 34 for more information.
Gateway IP Address	Enter the gateway IP address in the field provided. This option only applies if you disable DHCP.
Net Mask IP Address	Enter the network mask IP address in the field provided. This option only applies if you disable DHCP.
<b>DNS</b>	
Enable mDNS	Enables Multicast DNS on all devices when checked. This option is checked by default. <i>Warning: Disabling this option prevents DCS from seeing the device again. DCS will only see the device again after restoring the factory defaults, which causes you to lose all configuration and scripting data.</i>
Domain Suffix	Enter the domain suffix in the field provided. This option only applies if you disable DHCP.
DNS IP	Enter the IP address of the domain server in the fields provided. You can enter up to three IP addresses in the three individual fields. This option only applies if you disable DHCP.
<b>Connections</b>	
Enable RMS	Enable RMS on all devices when checked. This option is checked by default.
Preferred RMS Server IP Address	Enter the IP address of the RMS server in this field.
RMS Peer Group	Enter the address of the RMS peer group in this field. <i>Note: If you set the RMS Peer Group to an empty value, then that ControlPad will disappear from RMS, as the RMS Proxy will no longer see it. If you want to set the RMS Peer Group to an empty value, you must restore the factory defaults for the ControlPad.</i>
RMS Proxy Port	Displays the proxy port for the RMS server. This field is view-only.
Enable DCS	Enable DCS on all devices when checked. This option is checked by default. <i>Warning: Disabling this option prevents DCS from seeing the device again. DCS will only see the device again after restoring the factory defaults, which causes you to lose all configuration and scripting data.</i>
DCS Port	Displays the port DCS is using. This field is view-only.
<b>NTP</b>	
Enable NTP	Enables the Network Time Protocol (NTP) on all devices when checked. This option is unchecked by default.
Primary NTP Server	Enter or use the menu to select the primary NTP server.
Secondary NTP Server	Enter or use the menu to select the secondary NTP server.
Tertiary NTP Server	Enter or use the menu to select the tertiary NTP server.
Update Frequency	Use the menu to select an update frequency for the NTP server. You can choose from 15 minutes, 30 minutes, 1 hour, 2 hours, 4 hours, and 24 hours.
Time Zone	Use the menu to select the NTP time zone.

Configure Global Device Settings Window Options (Cont.)	
Enable Daylight Savings	Click this check box to turn on Daylight Savings. When enabled, all options within this area are active. This option is unchecked by default.
Offset	Use the hour and minute menus to indicate the amount of the time change when Daylight Savings is active.
Starts	Use the available menus to indicate the time when Daylight Savings begins including month, day of the week, week of the month, and time of day.
Ends	Use the available menus to indicate the time when Daylight Savings ends including month, day of the week, week of the month, and time of day.
<b>Web</b>	
Enable HTTP Web Server	Enables the HTTP web server on all devices when checked. This option is unchecked by default. This option enables access to web pages for all devices. See the <i>Web Console</i> section on page 59 for more information on the web pages.
Administrator Name	Enter the web server administrator name in this field. The default administrator name is <b>Admin</b> and is populated in the field by default. This option is for future use. Any change in the administrator name is not reflected in web access.
Administrator Password	Enter the web server administrator password in this field. The default password is <b>1988</b> and is populated in the field by default. This option is for future use. Any change in the administrator password is not reflected in web access.
HTTP Port	Enter the web HTTP port in this field. The default HTTP port is <b>80</b> and is populated in the field by default.
Download Logo to Device	You can download a logo to device when checked. This field is not available until you load a logo image.
Select Image	Click this button to load an image. Clicking this button opens a browser window you can use to navigate to the image's location. The image must be no greater than 7K in size.
View Image's Actual Size	Click this button to view the image's actual size. Clicking this button opens the <i>View Image</i> dialog.
Image Dimension	Displays the loaded image's dimension in pixels. This information is view-only.
Image Size	Displays the loaded image's size in bytes. This information is view-only.

### Enabling the HTTP Web Server

Perform these steps to enable the HTTP web server and allow user access to web pages for all devices:

1. Access the Device Configuration Layout & Inspector window (FIG. 35).
2. Click **Global Settings**. The Configure Global Device Settings window opens (FIG. 38).
3. Click **Web**.
4. Click **Enable HTTP Web Server**.

### Configuring Device Settings

At the device level, you can set individual settings for a single device or use the global device settings set for the project. Select a device and click the Device Settings button to access the Configure Device Settings window (FIG. 39).

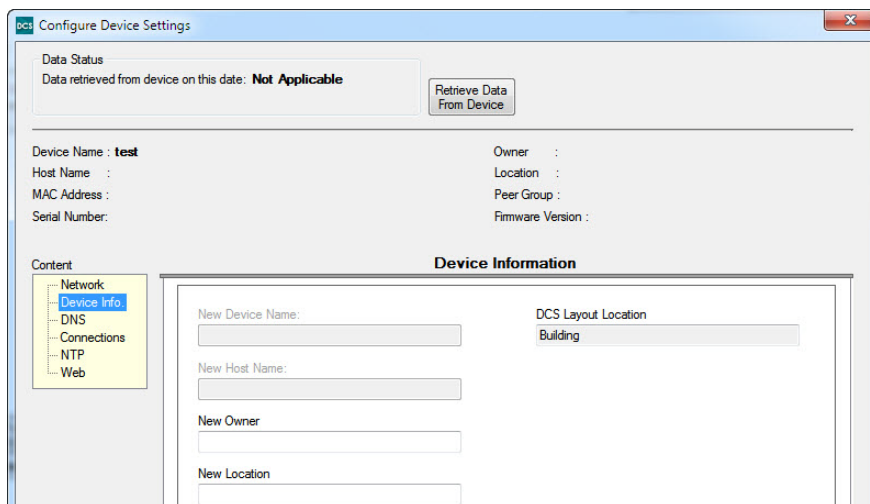

**FIG. 39** Configure Device Settings window

The window contains six separate screens with settings for Network, Device Info, DNS, Connections, NTP, and Web. Click the option you want in the Content area to view or change the settings for each type. The Network, DNS, Connections, NTP, and Web screens are identical to the screens containing the global settings configuration options, but they each also include an option to use the global settings for the device.

The following table lists the options for the Device Info screen. You must configure these options if you disable DHCP in the Configure Global Device Settings window.

Configure Device Settings Window Options	
Retrieve Data from Device	Click this button to retrieve information about the ControlPad. Clicking the button opens the Retrieve Device Information window.
New Device Name	Enter the new name for the device in the provided field.
New Host Name	Enter the host name for the device in the provided field.
New Owner	Enter the name of the owner of the device in the provided field. Once accepted, data entered appears in the header section.
New Location	Enter the new RMS location of the device in the provided field. Once accepted, data entered appears in the header section.
DCS Layout Location	The location of the keypad in the project. This value reflects where the keypad appears in the Device Configuration Layout. You may see Project, Building, House, Classroom/Room, or Device listed here. This area is view-only.

The current configuration of the currently selected ControlPad displays at the top of the window. The information that appears includes: Device Name, Host Name, MAC Address, Serial Number, Owner, Location, Peer Group (for RMS), and Firmware Version. Some of these fields may be blank if they have not yet been set, or were cleared during programming.

## Device Interface

AMX DCS programs the buttons on your ControlPad. Using the device interface and the options provided, you can program each individual button, including the navigational pad buttons (#18-22), and the volume knob button (#23). You can also program events for the two directional turns of the volume knob button.

**NOTE:** The knob button is only available on CP-3008 and CP-3017 model ControlPads. The navigational pad buttons are only available on CP-3017 ControlPads.

The Selected Device section displays specific information for the ControlPad (FIG. 40).

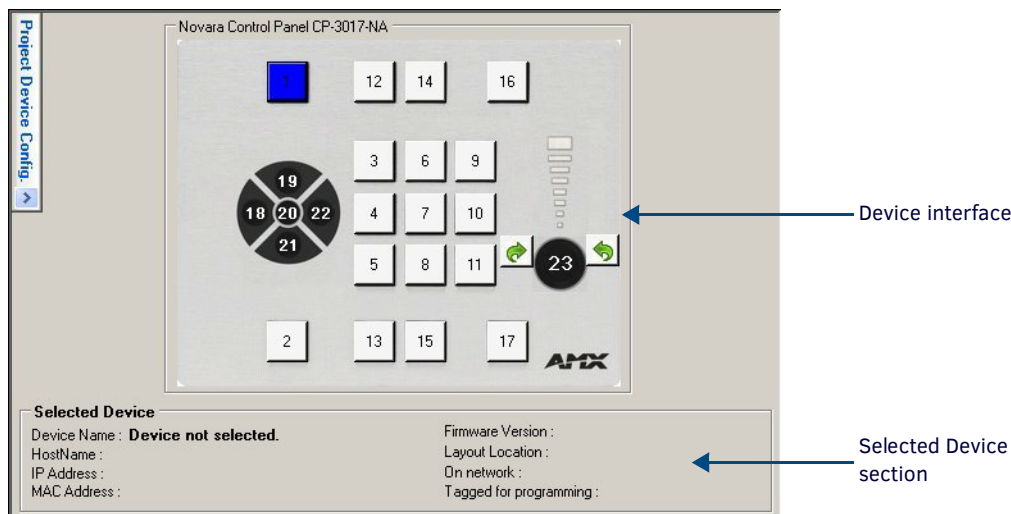

FIG. 40 DCS graphical representation of your ControlPad

Clicking a button on the device interface reflects the event button number on the right side of the screen (FIG. 41). Likewise, selecting a button from the Button Number menu changes the object selected on the device interface.

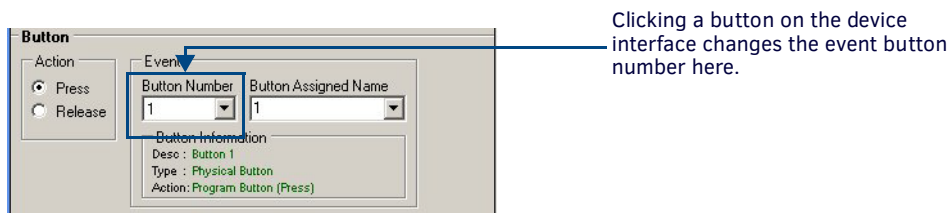

FIG. 41 Button area

## Device Setup

The following sections describe the options available for event scripting for each keypad.

### Scripting

The Scripting area enables you to program a series of events and upload the program to the device. In this area, you can view the script as it currently exists, and add, delete, or re-arrange the order of events as needed.

- The maximum number of events you can add to a script is 255.
- The maximum total number of scripted events across all scripts is 6000.
- All script events must be programmed at the same time.
- If you program a script and send it to a device, then create a second script and send it to the device, the second script replaces the first script.
- You can also create boot-up scripts which executes when a device boots-up and before any input is accepted by the ControlPad. See the *Creating a Boot-Up Script* section on page 50 for more information.

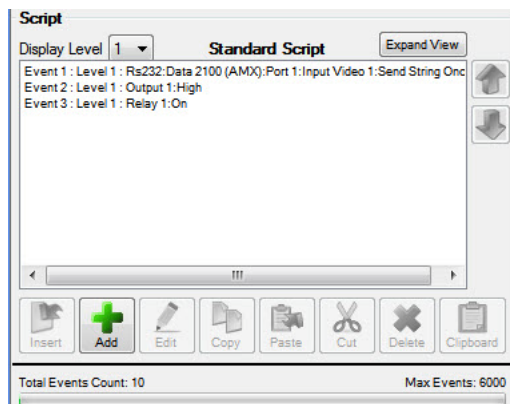

FIG. 42 Scripting area

The following table lists the Scripting options:

Scripting Options	
Display Level	Click to display only the events belonging to a particular bank or toggle level. You can choose from All or any number from 1-4. This option is not available if you set the Button Behavior Action Type to Normal.
Expand View	Click to open the Script window. The Script window displays a larger, more easily readable version of the scripting area. All button options from the Scripting area appear in the window and you can use these options to edit, copy, cut, paste, and delete events from the script. While the Script window is open, you cannot access the script in the AMX DCS window. An Expanded View Active message appears in the Scripting area when the Script window is open.
Insert	Click to insert an event above the selected event in a script. This button appears grayed-out until you select an event within the script.
Add	Click to add an event to the script. Clicking this button adds the current event from the Content area on the left side of the screen to the script. The maximum number of events you can add to a script is 255.
Edit	Click to open the Script Event Editor so you can edit the selected event. In the Script Event Editor, the options that appear depend on the type of event you are editing. For example, if you are editing a Button Backlight event, the Button Backlight options appear in the Editor. Make any changes, then click Save to close the Editor.
Copy	Click to copy the selected events into memory. This button appears grayed-out until you select an event within the script. These events can be viewed by clicking Clipboard.
Paste	Click to place the events on the current clipboard into the script. The events are inserted at the end of the script. To insert the events into another part of the script, use the Insert button. This button appears grayed-out until you use Cut or Copy to save an event to the clipboard buffer.
Cut	Click to copy the selected events into memory and remove them from the script. This button appears grayed-out until you select an event within the script. These events can be viewed by clicking Clipboard.
Delete	Click to remove an event from the script. You can highlight multiple events to delete them all with one click. This button appears grayed-out until you select an event within the script.
Clipboard	Opens the DCS Clipboard Buffer window (FIG. 44) so you can view the items currently saved in current memory. This button appears grayed-out until you use Cut or Copy to save information to the clipboard buffer.

FIG. 43 displays the Script window:

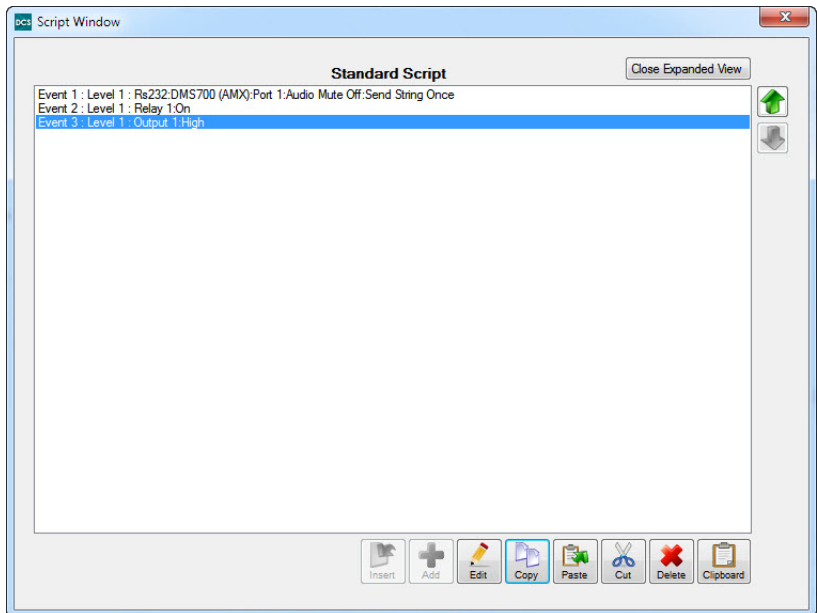

FIG. 43 Script Window

Click **Close Expanded View** to close the Script window.

FIG. 44 displays the DCS Clipboard Buffer window.

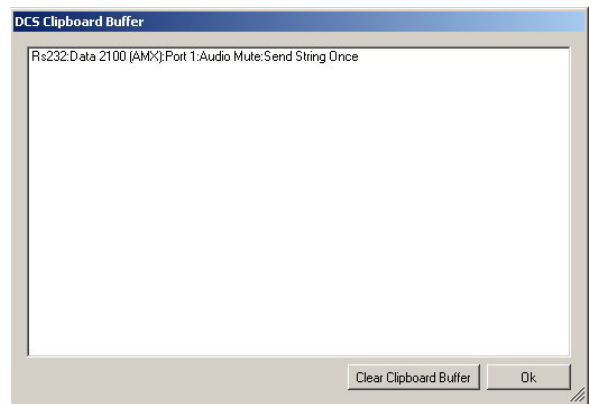

FIG. 44 DCS Clipboard Buffer

Click **Clear Clipboard Buffer** to remove all data from the clipboard. Click **OK** to close the window.

### Setup

Setup contains five options for your ControlPad: Button Backlight, Button Behavior, Button Groups, Volume Control, and Interrogation. Click the plus sign (+) beside Setup to expand or collapse the available options.

### Button Backlight

The Button Backlight option enables you to set the backlight color and level for each button on the keypad. Select a button on the graphical representation of the keypad then select Button Setup to change the button backlight properties. You cannot add this option to a script. It is a global setting and is set when the ControlPad starts up. Once you select the color you want, you can program it by clicking the Program Devices button.

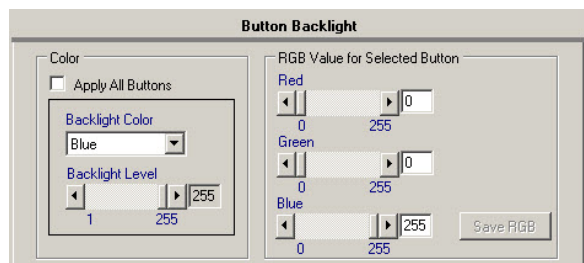

FIG. 45 Button Backlight options

**NOTE:** If you attempt to program a button's backlight color with an empty script, the ControlPad does not reflect the change. You must program at least one line of a script for the color change to take effect.

The following table lists the Button Backlight options:

Button Backlight Options	
Apply All Buttons	Check this box to apply the backlight color, level, and default RGB values to all buttons on the keypad. If checked, the RGB Value section is disabled. If unchecked, the RGB Value section is enabled. A warning appears if you choose to check this option.
Backlight Color	Select a button color from the menu. Default RGB Values appear in the RGB section on the right based on selected color.
Backlight Level	Use the slider to set the backlight level of the button between 1 and 255. You can also use your pointer to select the text in the field beside the slider and manually enter the backlight level for the button. <i>Note: You cannot turn off the backlight level by setting the level to 0.</i>
RGB Value for Selected Button	This section holds the RGB values for the Backlight color selected. You can create a custom RGB by modifying the colors shown in this section. The Save RGB button activates if you make any RGB color changes.
Save RGB	Saves your custom backlight color. This button only becomes active after you make an RGB color change.
Default RGB	Restores the backlight color to its default state.

### Setting the Backlight Color Of a Button

1. In the AMX DCS window, click the plus sign (+) beside Setup in the Content area. A list of setup options appear.
2. Click **Button Backlight**. The Button Backlight options appear (FIG. 45).
3. If you want the backlight settings to affect all buttons, click the **Apply All Buttons** check box.
4. Select the button color from the Backlight Color options menu.
5. Use the **Backlight Level** slider to set the backlight level for the button.
6. In the Scripting area, click **Program Devices**. The backlight color is sent to the ControlPad.

**NOTE:** Due to the nature of RGB LEDs, you may discover that certain color and brightness settings, when applied across all buttons on a ControlPad, have minor variations in color. If this is noticeable, the recommended solution is to adjust the color on buttons individually until the colors match across all buttons.

### Button Behavior

A button can be assigned to one of four banks W, X, Y, or Z. Each bank can have up to four different functions. This is useful if you have a common set of functions. For example, you could have a single 'Play' button controlling up to four different devices (e.g. DVD, VCR, CD, MP3 player, etc). To achieve this, you must enable a bank and assign a Play command to one or more buttons, and then assign the entire bank to another button.

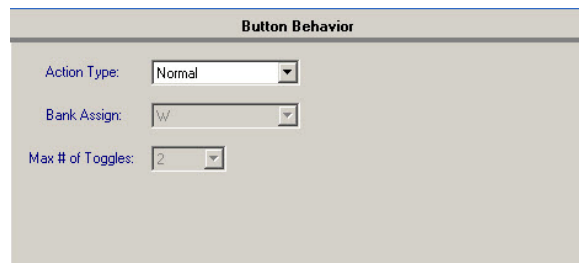

**FIG. 46** Bank Assign and Toggle options

The following table lists the Button Behavior options:

Button Behavior Options	
Action Type	You can choose from Normal, Bank, and Toggle. Selecting Bank activates the Bank Assign option. Selecting Toggle activates the Max # of Toggles option. Selecting the Bank or Toggle options also activates the respective Bank Level or Toggle Level option in the Inputs area on the AMX DCS window.
Bank Assign	This option enables you to select a bank of functions. This option is only available when you select Bank for the Action Type.
Max # of Toggles	This option enables you to set the maximum number of toggles. This option is only available when you select Toggle for the Action Type. The number of toggles you select reflects the number of toggles available in the Advance Toggle area.

## Button Groups

Button Groups allow you to assign buttons to groups and assign custom group names to a group of buttons. With this feature, you can create feedback events for buttons within groups. You can create up to 8 groups of buttons.

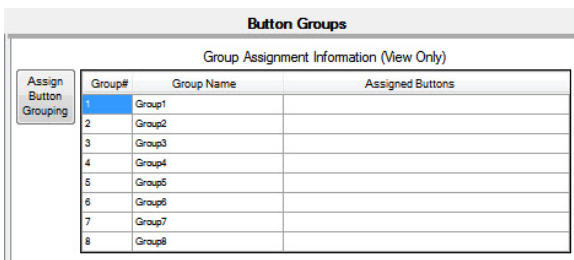

FIG. 47 Button Groups options

**NOTE:** Any button can be assigned to more than one group, but the button groups are not isolated from each other. An event which affects a button, affects the button within each group to which it is assigned. Cross-group functionality should only be an issue with button back-lighting and should not affect functionality for an individual button.

The following table lists the Button Groups options:

Button Groups Options	
Assign Button Grouping	Click this button to open the <i>Button Grouping</i> dialog.
Group Assignment Information	Use this area to view which ControlPad buttons have been assigned to each of the 8 button groups. This area is view-only.

### Assigning a Button To a Button Group

1. Open the AMX DCS window.
2. Select **Button Groups** in the Content area. The Button Groups options appear (FIG. 47).
3. Click **Assign Button Grouping**. The *Button Grouping* dialog opens (FIG. 48).

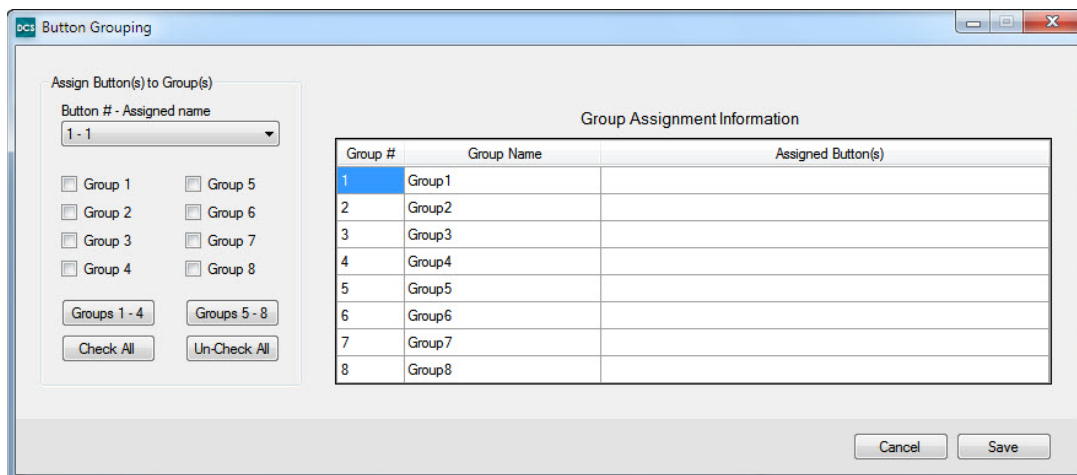

FIG. 48 Button Grouping dialog

4. Use the **Button # - Assigned Name** options menu to select a ControlPad button.
5. Click the appropriate Group check boxes to assign the selected ControlPad button to a group. Click **Check All** to assign the button to all groups.
6. Repeat steps 4 and 5 to assign more ControlPad buttons.
7. Click **Save**. The dialog closes and the button assignments appear in the Group Assignment Information area in the AMX DCS window.



## Volume Control

The Volume Control area enables you to set the maximum and default volumes for any device connected to the ControlPad. You cannot add this option to a script. It is a global setting and is set when the ControlPad starts up. Once you select the volume levels you want, you can program it by clicking the Program Devices button.

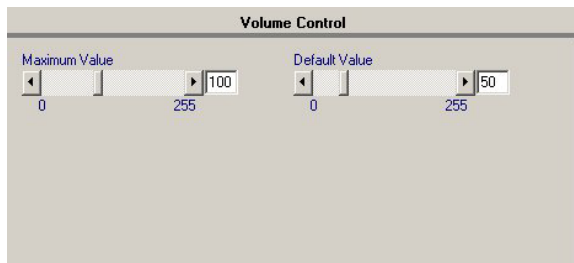

FIG. 49 Volume Control options

The following table lists the Volume Control options:

Volume Control Options	
Maximum Value	Use the slider to set the maximum volume.
Default Value	Use the slider to set the default value. The default maximum value is based on the Maximum value you set. For example, if you set your maximum value to 50, you set the default value to any number between 0 and 50.

### Setting the Volume Control For a Device

1. In the AMX DCS window, click the plus sign (+) beside Setup in the Content area. A list of setup options appear.
2. Click **Volume Control**. The Volume Control options appear (FIG. 49).
3. Use the **Maximum Value** slider to set the maximum volume for the device.
4. Use the **Default Value** slider to set the default volume for the device.
5. In the Scripting area, click **Program Devices**. The volume settings are sent to the ControlPad.

**NOTE:** If you attempt to program the volume with an empty script, the ControlPad does not reflect the change. You must program at least one line of a script for the new volume settings to take effect.

### Interrogation

The Interrogation option enables you to assign specific devices that are connected to the ports on the rear of the ControlPad. After assigning devices, you can view the request and status names and the hexadecimal command codes for each device. You can also view or change the Request and Status commands for RMS.

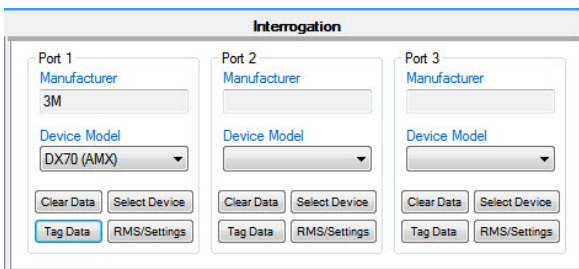

FIG. 50 Interrogation options

The following table lists the Interrogation options:

Interrogation Options	
Manufacturer	Displays the manufacturer of the device. This option is view-only on this screen. You can only change it by clicking Select Device and selecting a different Make.
Device Model	Use the drop-down menu to select the model of the device for the manufacturer. No devices appear in this menu until you use the Select Device option to select a model and device type.
Clear Data	Click to clear the device from the corresponding port. You must clear and reselect a device to pick up any changes to the device in the Device Library entry. Otherwise, the original RS-232 commands, responses, and formulas remain in the script, despite the library being updated.
Select Device	Click to open the <i>DCS Device Library</i> dialog so you can select a device for the port.
Tag Data	Click to open the Device Interrogation window and select which requests you want to be programmed on the ControlPad.
RMS/Settings	Click to open the Assign RMS Custom Request and Status Names window which displays the Request and Status names. You can enter custom names and select the Timeout/Time for Response settings.



### Assigning a Device To a ControlPad

1. In the AMX DCS window, click the plus sign (+) beside Setup in the Content area. A list of setup options appear.
2. Click **Interrogation**. The Device Interrogation options appear (FIG. 50).
3. Click **Select Device**. The *DCS Device Library* dialog opens (FIG. 51).



FIG. 51 DCS Device Library dialog

4. Use the **Make** and **Type** menus to select the manufacturer and type of device, and click **Load Devices**. The dialog closes and the make is populated in the Manufacturer field of the Device Interrogation options.
  5. Use the **Device Model** menu to indicate the specific device connected to the port. If you do not see the device, you may need to add it to the Device Library. See the *Adding a Device to the Device Library* section on page 55 for more information.
- In the AMX DCS window, click **Tag Data** to open the Device Interrogation window (FIG. 52) and view the details of the device.

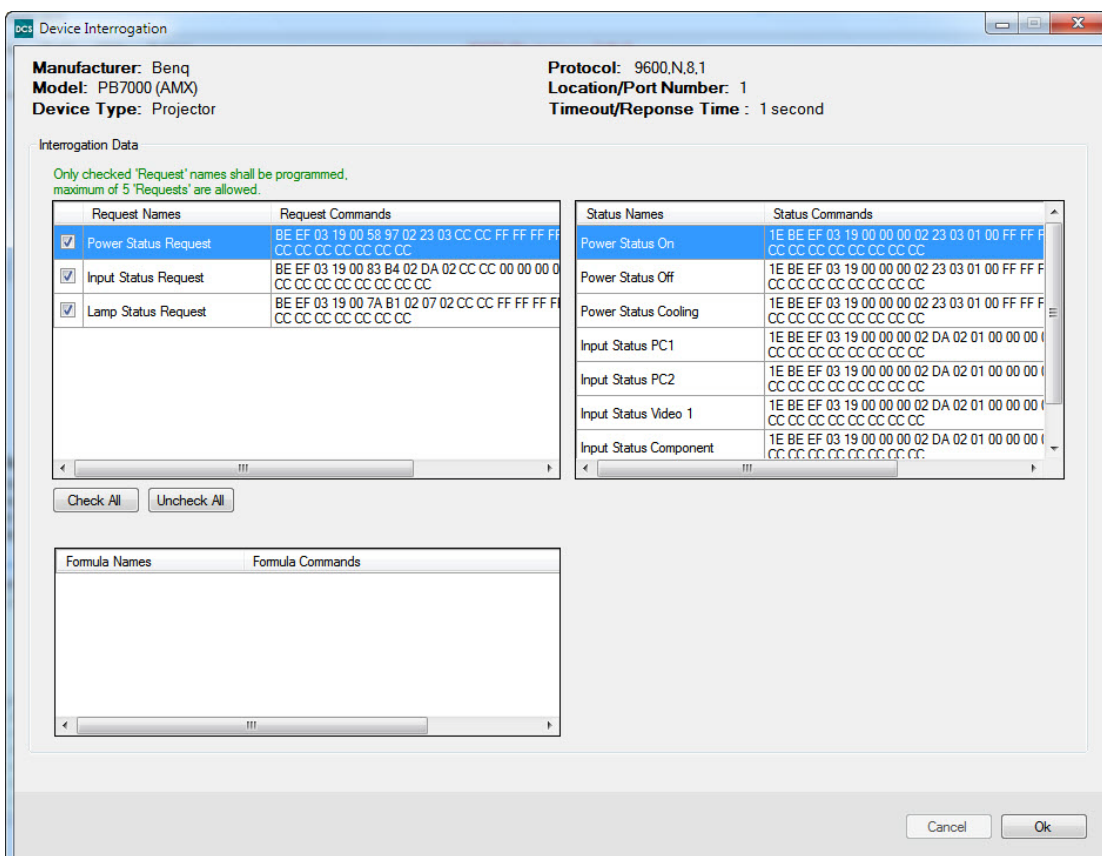
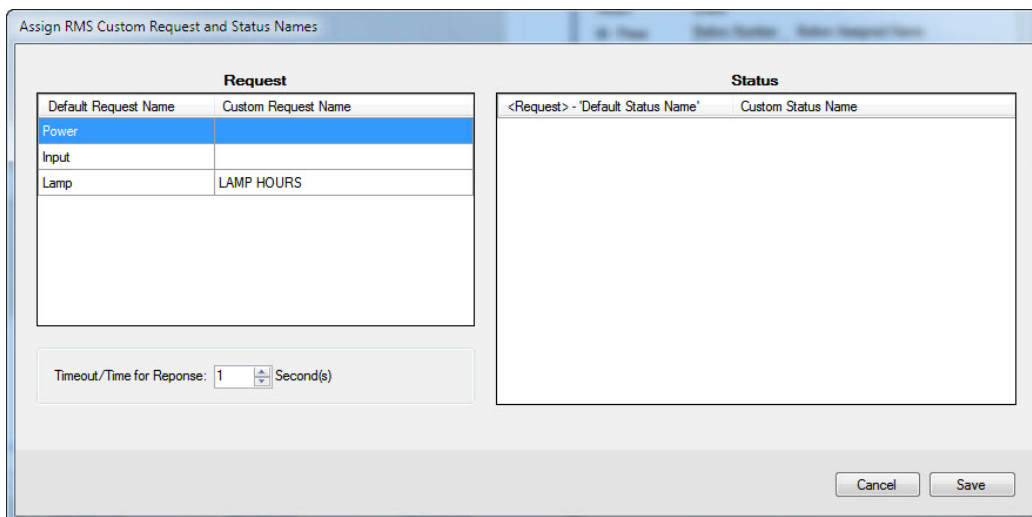

FIG. 52 Device Interrogation window

You can check a maximum of five Request names to be programmed for the device. DCS auto-checks all interrogation requests if there are five or fewer requests available for the device.

6. In the AMX DCS window, click **RMS/Settings** to open the Assign RMS Custom Request and Status Names window (FIG. 53). This window enables you to enter custom request and status names for RMS and set the response timeout for the device.



**FIG. 53** Assign RMS Custom Request and Status Names window

**Changing the Custom Request and Status Names For RMS**

1. In the AMX DCS window, click the plus sign (+) beside Setup in the Content area. A list of setup options appear.
2. Click **Interrogation**. The Device Interrogation options appear (FIG. 50).
3. Click **RMS/Settings**. The Assign RMS Custom Request and Status Names window opens (FIG. 53).
4. Change the custom request or status name by clicking **Custom Request Name** or **Custom Status Name** beside the default request or status name until a cursor appears, and enter the new name in the space provided.
5. Use the arrow buttons beside the **Timeout/Time for Response** option to set the response time, in seconds, for the device.
6. Click **Save**.

**Feedback**

Feedback contains two options for your ControlPad: Buttons and Volume Bar. Click the plus sign (+) beside Feedback to expand or collapse the available options.

**Buttons**

The Feedback option configures button feedback for the keypad. This allows you to program whether the button displays specific information under a certain condition. For example, the button may change to a different color after it is pressed to power on a device.

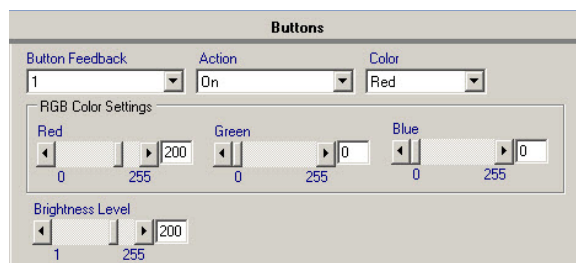

**FIG. 54** Buttons options

The following table lists the Buttons options:

<b>Buttons Options</b>	
Button Feedback	Enables you to select the button on ControlPad you want to use to provide feedback. You can also click the button on the graphical representation of the ControlPad in the DCS window to select the button for this option.
Action	Enables you to indicate whether you want to activate button feedback. You can choose from On, Backlight, Flash, Full Off, On / All Buttons Off, On / Group Off, On / All Buttons Backlight, and On / Group Backlight. Selecting Full Off turns off button feedback and reduces LED power to zero. Selecting Group Off or Group Backlight sets the event for all buttons assigned to a button group. See the <i>Button Groups</i> section on page 39 for more information.
Color	Enables you to indicate the color of the button feedback for the specified action.
RGB Color Settings	Use the sliders to set a custom color for the button feedback.
Brightness Level	Use the slider to set the brightness level of the button between 1 and 255. You can also use your pointer to select the text in the field beside the slider and manually enter the brightness level for the button. <b>Note:</b> You cannot turn off the brightness level by setting the level to 0.

### Setting Button Feedback

1. In the AMX DCS window, click the plus sign (+) beside Feedback in the Content area. A list of feedback options appear.
2. Click **Buttons**. The Buttons options appear (FIG. 54).
3. Select the button number from the **Button Feedback** options menu.
4. Use the Action options menu to indicate whether you want to turn on button feedback. Selecting **Off** turns off button feedback.
5. Select a color from the **Color** options menu, or use the **RGB Color Settings** sliders to indicate a different color from those listed.
6. In the Scripting area, click **Add**. The Feedback event now appears in the script.

### Volume Bar

The Volume Bar area enables you to set the brightness level for the volume indicator on the ControlPad.

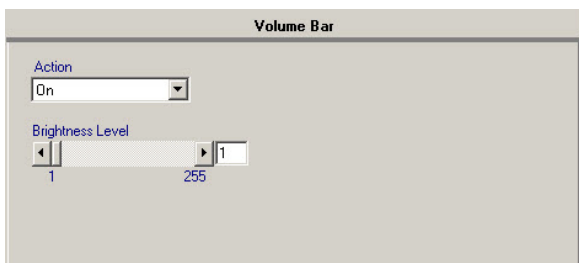

FIG. 55 Volume Bar options

The following table lists the Volume Bar options:

Volume Bar Options	
Action	Enables you to select the volume LED action type. You can choose from On, Flash, or Power Off.
Brightness Level	Use the slider to set the brightness level of the button between 1 and 255. You can also use your pointer to select the text in the field beside the slider and manually enter the brightness level for the button. <i>Note: You cannot turn off the brightness level by setting the level to 0.</i>

### RS232

The RS232 option configures an RS232 device for the keypad. RS232 devices connect to the RS232 serial ports on the rear of the keypad. You must use the Device Library Manager to add or import RS232 devices that you can program through DCS. Once the device you want to program is in the device library, you can load the device in the RS232 section and program events for it. See the *Device Library Manager* section on page 53 for more information.

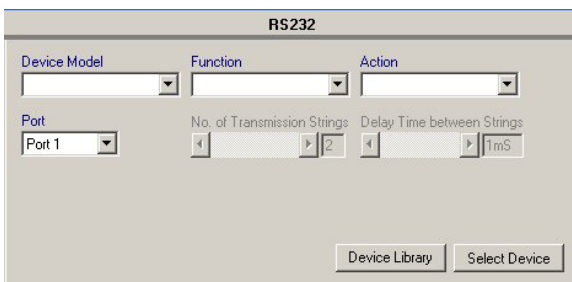

FIG. 56 RS232 options

The following table lists the RS232 options:

RS232 Options	
Device Model	Enables you to select the device connected to the RS232 port on the ControlPad. If no devices are available from the drop-down menu, click <b>Select Device</b> to select and load a device. If no devices are available, click <b>Device Library</b> to add a device. See the <i>Device Library Manager</i> section on page 53 for more information.
Function	Enables you to select a function for the device to perform. Functions include options such as audio or video mute, power on/off, input switching, and volume control. You can program functions using the Device Library Manager. See the <i>Device Library Manager</i> section on page 53 for more information.
Action	Enables you to select the number of times you want the function to execute. You can choose from Send String Once, Send String No., and Send Continuously.
Port	Enables you to select the port on the ControlPad you want to use to execute the function. The number of ports available varies depending on the type of ControlPad you are using.

RS232 Options	
No. of Transmission Strings	Use the slider arrows to indicate the number of times you want a function to transmit. You can also enter a number in the space provided. You can set any amount between 2 and 50. This option is only available if you select Send String No. from the Action menu.
Delay Time between Strings	Use the slider arrows to indicate how often you want the function to repeat. You can also enter a number in the space provided. You can set any amount of time between 10 and 2500 milliseconds. This option is only available if you select Send String No. from the Action menu.
Device Library	Click to access the Device Library Manager. See the <i>Device Library Manager</i> section on page 53 for more information.
Select Device	Click to open the DCS Device Library window. Using this window, you can select an RS232 device to program.

**Adding an RS232 Event To a Script**

1. In the AMX DCS window, click **RS232**. The RS232 options appear (FIG. 56).
2. Click **Select Device** to open the *DCS Device Library* dialog (FIG. 57).



**FIG. 57** DCS Device Library dialog

3. Select the manufacturer of the device you want to program from the **Make** options menu.
4. Select the type of device from the **Type** options menu.
 

**NOTE:** If the *Make* and *Type* fields are blank, you need to use the *Device Library Manager* to create or import devices. See the *Adding a Device to the Device Library* section on page 55 and the *Importing a Device Library* section on page 55 for more information.
5. Click **Load Devices** to close the dialog and return to the AMX DCS window. You should now see the Device Model and Function menus populated with one or more options.
6. Select a device model from the **Device Model** options menu.
7. Select a function from the **Functions** menu.
8. Select the number of times you want the function to occur from the Action menu. If you choose **Select Send No.**, do the following:
  - Use the **No. of Transmission Strings** slider to indicate the number of times you want the function to transmit.
  - Use the **Delay Time between Strings** slider to indicate the amount of time in between each occurrence of the function.
9. Select the RS232 port the device is connected to from the Port options menu.
10. In the Scripting area, click **Add**. The RS232 event now appears in the script.

**IR**

The IR option configures an IR device for the keypad. IR devices connect to the IR ports on the rear of the keypad.

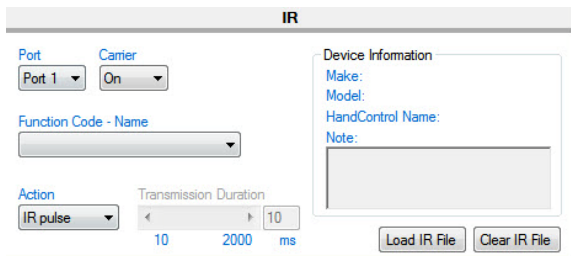

**FIG. 58** IR options

The following table lists the IR options:

IR Options	
Port	Enables you to select the port on the ControlPad you want to use to execute the function. The number of ports available varies depending on the type of ControlPad you are using.
Carrier	Enables you to turn on the carrier. When hard-wiring to a device, the carrier may have to be turned off. Otherwise, carrier must be left On.

IR Options (Cont.)	
Function Code - Name	Enables you to select a function code for the device to perform.
Action	Enables you to select the number of times you want the function to execute. You can choose from IR Pulse and IR Duration.
Transmitter Duration	Use the slider arrows to indicate the amount of time, in milliseconds, you want a function to transmit. You can set any amount between 10 and 2000. This option is only available if you select IR Duration from the Action menu. <b>Note:</b> If you set the Transmission Duration slider to a value in milliseconds, which is less than the full pulse length of the IRL file's recorded pulse, the ControlPad sends at least 1 full pulse when the script is triggered. Fractional IR pulses are not supported. Additionally, if you set the value to a number greater than the length of the pulse, the ControlPad sends as many pulses as possible that fit into the time frame. No fractional pulses are sent.
Device Information	Displays the Make, Model, and HandControl Name of the IR device, as well as any additional information in the Note area. This information is view-only.
Load IR File	Click to load an AMX IR file (.irl) containing information about your IR device. You must load an .irl file for each port.
Clear IR File	Click to clear the loaded IR file (.irl) for the port.

### Adding an IR Event To a Script

1. In the AMX DCS window, click **IR**. The IR options appear (FIG. 58).
2. Click **Load IR File for Selected Port**. An *Open* dialog appears with which you can navigate to the location of an AMX IR file (.irl) containing information about your IR device. After you have selected the appropriate file, click **OK**.
3. Select the IR port the device is connected to from the Port options menu.
4. Select a function from the Function Code options menu.
5. Select the number of times you want the function to occur from the Action menu. If you select IR Duration, use the Transmitter Duration slider to the amount of time, in milliseconds, you want a function to transmit.
6. In the Scripting area, click **Add**. The IR event now appears in the script.

### Relay

The Relay option enables you to activate any devices connected to the relay on the rear of the keypad.



FIG. 59 Relay options

The following table lists the Relay options:

Relay Options	
Relay	Enables you to select the relay to control.
Action	Enables you to select the relay action type. You can choose from On or Off.

### Activating a Relay

1. In the AMX DCS window, click **Relay**. The Relay options appear (FIG. 59).
2. Select the relay from you want to activate from the **Relay** options menu.
3. Select **On** from the **Action** options menu to activate the relay. Selecting **Off** deactivates the relay.
4. In the Scripting area, click **Add**. The Relay event now appears in the script.

### Output

The Output option enables you to indicate which port you want to use as an output.

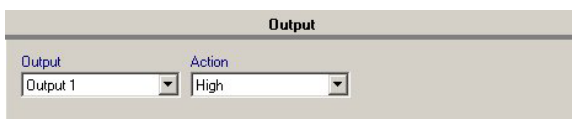

FIG. 60 Output options

The following table lists the Output options:

Output Options	
Output	Enables you to select the output.
Action	Enables you to select the output action type. You can choose from High or Low.

## Setting Up an Output

1. In the AMX DCS window, click **Output**. The Output options appear (FIG. 60).
2. Select the output from you want to use from the **Output** options menu.
3. Select the output action type from the **Action** options menu.
4. In the Scripting area, click **Add**. The Output event now appears in the script.

## Delay

The Delay option enables you to insert a period of inaction into a script. Delays can range from 1 second up to 9 minutes and 59 seconds. The delay is absolute and no other Event or Button press is acknowledged until the time period has elapsed.

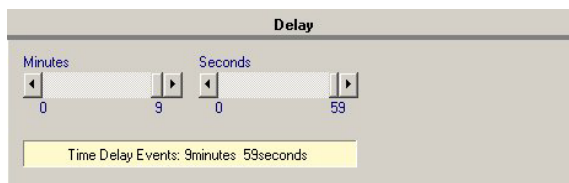

**FIG. 61** Delay options

The following table lists the Delay options:

Delay Options	
Minutes	Use the slider to indicate the number of minutes in the delay. You can set up to 9 minutes.
Seconds	Use the slider to indicate the number of seconds in the delay. You can set up to 59 seconds.
Time Delay	This area displays the amount of time for the delay in minutes and seconds and reflects the movement of each of the sliders.

## Setting a Delay In a Script

1. In the AMX DCS window, click **Delay**. The Delay options appear (FIG. 61).
2. Use the Minutes and Seconds sliders to set the amount of time for the delay.
3. In the Scripting area, click **Add**. The delay now appears in the script.

## Lockout Buttons

The Lockout Buttons option enables you to set a passcode for activating the keypad. With a lockout activated, a user must enter a series of button presses before using the keypad. The passcode can be a sequential order of button presses or a collection of button to be pressed simultaneously. You can program up to four buttons in one combination.

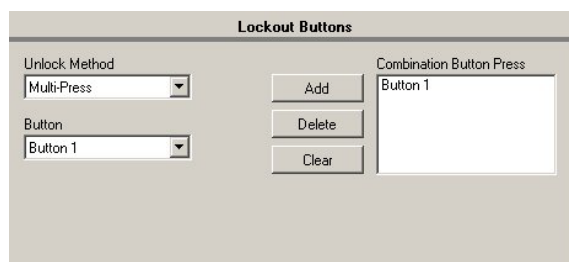

**FIG. 62** Lockout Buttons options

The following table lists the Lockout Buttons options:

Lockout Buttons Options	
Unlock Method	Choose the method you want to use to unlock the keypad. You can choose from Sequence or Multi-Press. Sequence indicates you must use a series of key presses in a particular order to unlock the keypad. Multi-Press indicates the designated buttons are to be pressed simultaneously.
Button	Select a button you want to include in the button combination.
Add	Click to add the selected button to the button combination. If you try to add a button that is already in a multi-press combination, you will receive an error message. This option is disabled once you have added four buttons to a combination.
Delete	Click to remove the selected a button from the button combination.
Clear	Click to remove all buttons from the button combination.
Combination Button Press	Displays the current button combination.

### Setting a Button Lockout

1. In the AMX DCS window, click **Lockout Buttons**. The Lockout Buttons options appear (FIG. 62).
2. From the Unlock Method options menu, select whether you want the passcode to be a sequential order of button presses (**Sequence**) or a collection of button to be pressed simultaneously (**Multi-Press**).
3. Select a button from the Button menu, and click **Add** to add the button to the Combination Button Press list. Repeat this step until you have a complete passcode (up to four button presses).
4. In the Scripting area, click **Add**. The button lockout now appears in the script.

### Bank Enable

You can use this option to enable a bank for a single button. Using this option, you can select a bank and add it to a script. There are four banks available (W, X, Y, and Z) with each bank containing four separate options.

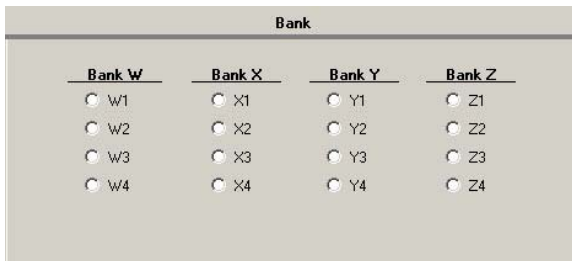

FIG. 63 Bank Enable options

### Example: Using the Bank Enable Option

1. In the AMX DCS window, click Button 1 on the ControlPad interface.
2. Click **Bank Enable**. The Bank Enable options appear (FIG. 63).
3. Select **W1**, and click **Add** to add the bank enable function to your script.
4. Click Button 2 on the ControlPad interface.
5. Select **W2** from the Bank Enable options, and click **Add** to add the bank enable function to your script.
6. Click Button 3 on the ControlPad interface.
7. Select **W3** from the Bank Enable options, and click **Add** to add the bank enable function to your script.
8. Click Button 4 on the ControlPad interface.
9. Select **W4** from the Bank Enable options, and click **Add** to add the bank enable function to your script.
10. Click Button 5 on the ControlPad interface.
11. Click **Button Behavior**. The Button Behavior options appear (FIG. 46).
12. Set the Action Type to **Bank**.
13. From the Bank Assign menu, select **W**.
14. In the Content area, click the plus sign (+) beside Feedback to expand the tree.
15. Select **Buttons**. The Buttons options appear (FIG. 54).
16. Select **Red** from the Color menu, and select **1** from the Bank Level menu on the right side of the window (FIG. 64).

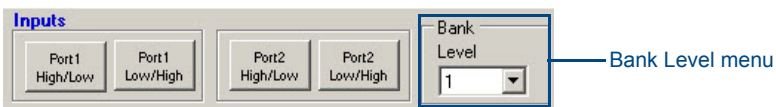

FIG. 64 Bank Level menu

17. Click **Add** to add the event to the script.
18. Select **Green** from the Color menu, and select **2** from the Bank Level menu on the right side of the window.
19. Click **Add** to add the event to the script.
20. Select **Blue** from the Color menu, and select **3** from the Bank Level menu on the right side of the window.
21. Click **Add** to add the event to the script.
22. Select **Yellow** from the Color menu, and select **4** from the Bank Level menu on the right side of the window.
23. Click **Add** to add the event to the script.
24. Click **Program Devices** to program the scripts on the selected ControlPads.

The ControlPad should now act in the following way:

- If you press Button 1 then press Button 5, Button 5 turns red.
- If you press Button 2 then press Button 5, Button 5 turns green.
- If you press Button 3 then press Button 5, Button 5 turns blue.
- If you press Button 4 then press Button 5, Button 5 turns yellow.

## Advance Toggle

The **Advance Toggle** feature allows a button to skip toggles. For example, a button is configured to toggle a Device on and off, and the first press turns on the device. With a toggle programmed into the script, a second press of the same button turns off the device. If the Device is also turned off by a Time Out function, then pressing the button a 2nd time will have no effect as the Device is already off.

If you are using a delay in a script with toggles, you should include an additional toggle at the end of the script in the event that the delay caused the ControlPad to miss a toggle. Pressing a button during a delay can cause any button events to not execute during the period of delay. An advance toggle at the end of the script switches the toggle to the next event in case it was not executed.

**NOTE:** You may find that executing a button press through RMS does not advance toggle. If this occurs in RMS, create a virtual button that contains all the events you want to run, and if you want to change the toggle level, use the advance toggle level to X script function.

In the AMX DCS window, click **Advance Toggle**. The Advance Toggle options appear (FIG. 65).

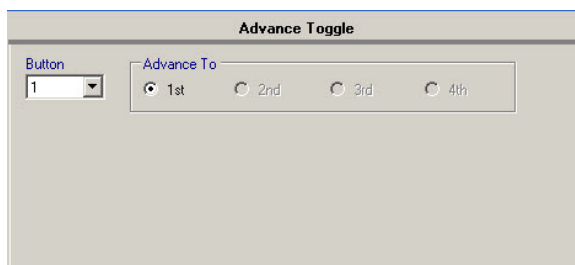

FIG. 65 Advance Toggle options

### Example: Using the Advance Toggle Option

1. In the AMX DCS window, click Button 1 on the ControlPad interface.
2. Select **Button Behavior** in the Content area, and ensure that the Action Type is set to Normal.
3. In the Content area, click the plus sign (+) beside **Feedback** to expand the tree.
4. Select **Buttons**. The Buttons options appear (FIG. 54).
5. Select **Red** from the Color menu, and **Add** to add the event to the script.
6. Click Button 2 on the ControlPad interface.
7. Select **Button Behavior** in the Content area, and set the Action Type is set to Toggle.
8. Set the **Max # of Toggles** option to 2.
9. Select **Buttons** in the Content area.
10. Select **Red** from the Color menu, and select **1** from the Toggle Level menu on the right side of the window (FIG. 66).

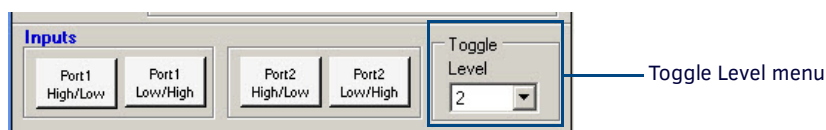

FIG. 66 Toggle Level menu

11. Click **Add** to add the event to the script.
12. Select **Green** from the Color menu, and select **2** from the Toggle Level menu on the right side of the window.
13. Click **Add** to add the event to the script.
14. Click Button 3 on the ControlPad interface.
15. Select **Button Behavior** in the Content area, and set the Action Type is set to Toggle.
16. Set the **Max # of Toggles** option to 3.
17. Select **Buttons** in the Content area.
18. Select **Red** from the Color menu, and select **1** from the Toggle Level menu on the right side of the window.
19. Click **Add** to add the event to the script.
20. Select **Green** from the Color menu, and select **2** from the Toggle Level menu on the right side of the window.
21. Click **Add** to add the event to the script.
22. Select **Blue** from the Color menu, and select **3** from the Toggle Level menu on the right side of the window.
23. Click **Add** to add the event to the script.
24. Click Button 4 on the ControlPad interface.
25. Select **Button Behavior** in the Content area, and set the Action Type is set to Toggle.
26. Set the **Max # of Toggles** option to 4.
27. Select **Buttons** in the Content area.



28. Select **Red** from the Color menu, and select **1** from the Toggle Level menu on the right side of the window.
29. Click **Add** to add the event to the script.
30. Select **Green** from the Color menu, and select **2** from the Toggle Level menu on the right side of the window.
31. Click **Add** to add the event to the script.
32. Select **Blue** from the Color menu, and select **3** from the Toggle Level menu on the right side of the window.
33. Click **Add** to add the event to the script.
34. Select **White** from the Color menu, and select **4** from the Toggle Level menu on the right side of the window.
35. Click **Add** to add the event to the script.
36. Click Button 5 on the ControlPad interface.
37. Select **Advance Toggle** in the Content area, and select button 4 from the Button menu.
38. Select **2nd** from the Advance to option buttons.
39. Click **Add** to add the event to the script.
40. Click **Program Devices** to program the scripts on the selected ControlPads.

The ControlPad should do the following:

- Pressing Button 1 causes the button to turn red.
- Pressing Button 2 causes the button to turn red. Pressing it again turns the button green.
- Pressing Button 3 causes the button to turn red. Pressing it again turns the button green. Pressing it a third time turns the button blue.
- Pressing Button 4 causes the button to turn red. Pressing it again turns the button green. Pressing it a third time turns the button blue. Pressing it a final time turns the button white.
- Pressing Button 5 then pressing Button 4 turns Button 4 green.

## Button Actions and Events

The Button area enables you to specify whether a button event occurs when the button is pressed or the button is released. You can also use this area to assign a name to a button or create custom names for devices.

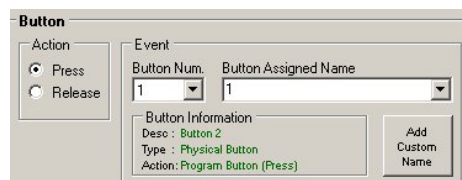

FIG. 67 Button Actions and Events area

The following table lists the options available in the Button area:

Button Actions and Events Options	
Action	Select whether you want the event to occur when the button is pressed or the button is released. You can program separate events for both pressing and releasing the button. (For example, pressing the button powers on a device while releasing the button changes the button color on the keypad.) <i>Note: The Release action is not supported for button presses received via the IR RX sensor. Additionally, since scripts cannot be interrupted, when using the release script you should take into account the fact that if a press script is still running when the release event occurs, then the release script will not run.</i>
Event Button Number	Select the button number you want to program from the menu. You can select a button number between 1 and 255. Buttons 30-255 are virtual buttons. Selecting a button from the Button Number menu changes the object selected on the graphical representation of the keypad. Likewise, clicking a button on the graphical representation of the keypad reflects the event button number on the right side of the screen.
Event Button Assigned Name	Assign a name to the button by selecting a pre-existing name from the list. You can also use your pointer to select the text in the menu field and enter a unique name for the button.
Add Custom Name	Enables you to create a custom button for AMX's Resource Management Suite (RMS). Clicking this button opens the <i>Custom Assigned Button Name</i> dialog. Using this dialog, you can enter any device ID number within the range of 2000-65536 and assign the name of a device or device function to it. (If you enter a number outside the device ID range, an error message appears.)

## Programming Virtual Buttons

In DCS, you can program any button between 30 and 255 as a virtual button. A virtual button allows you to program a series of commands to execute without pressing a physical button on a ControlPad. For example, use a virtual button to create a program which shuts down all devices in a room. Perform these steps to program a virtual button:

1. In the AMX DCS window, select a button number between 30 and 255 from the Button Number options menu.
2. Program a script containing any actions you want to occur.
3. Click **Program Devices**. The *Programming Device(s) Monitor* dialog opens and displays the list of devices to be programmed. For more information on programming a device, see the *Programming a Device* section on page 52.

**NOTE:** If you are using the CP-RC01 IR Remote, you can use virtual buttons 101-255 with it. See the CP-RC01 IR Remote on page 20 for more information.

### Creating a Custom Name for a Button

You can use AMX DCS to create customized buttons for RMS. Perform these steps to create a custom name for a button:

1. In the Button area, press **Add Custom Name**. The Custom Assigned Button Name dialog opens (FIG. 68).

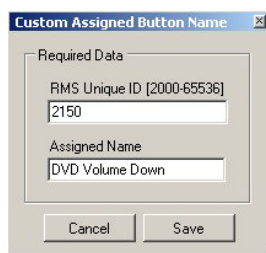

**FIG. 68** Custom Assigned Button Name dialog

2. Enter a device ID number within the range of 2000-65536 in the RMS Unique ID field. If you enter a number outside the device ID range, an error message appears.
3. Enter a name for the button in the Assigned Name field.
4. Click **Save**. The dialog closes and the custom button appears in the Button Assigned Name options menu.

### Inputs

The Input buttons enable you to program events for devices connected to the ports on the backside of the keypad. You can write scripts for ports that are detected to have transitioned from a High to a Low state, or from a Low to a High State.

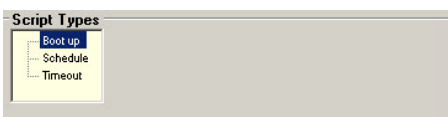

**FIG. 69** Inputs area

### Script Types

You can create three different types of scripts: Boot-Up, Schedule, and Timeout. When you select one of the script types, the Button section is disabled and the Script section shows the list of scripts for the selected script type. To create one of the above script types, you must do the following:

- Create a script
- Program the device with the script



**FIG. 70** Script Types area

### Creating a Boot-Up Script

A Boot-Up script allows you to create a list of scripts for boot up purposes. A Boot-Up script is the first script to execute on device boot up. Once you click the Boot-Up Script button, the Button section is disabled, and the Script section shows the list of scripts for Boot Up. Once the designated boot-up script is loaded to the device, the script executes when you launch the device. Perform these steps to create a boot-up script:

1. In the Script Types area, click **Boot Up**.
 

**NOTE:** All button actions and events are disabled. Clicking an object on the device interface exits Boot Up Script mode.
2. Program a script containing any actions you want to occur upon device launch.
3. Click **Program Devices**. The *Programming Device(s) Monitor* dialog opens and displays the list of devices to be programmed. For more information on programming a device, see the *Programming a Device* section on page 52.

## Creating a Schedule Script

A schedule script is a script which executes at a scheduled time. Once you set up a scheduled time, you can add events to the selected schedule script.

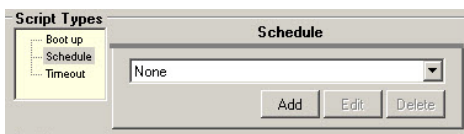

**FIG. 71** Schedule script

Perform these steps to create a schedule script:

1. In the Script Types area, click **Schedule**. A set of options appears in the blank space within the area (FIG. 71).
2. Click **Add**. The Schedule Properties window opens (FIG. 72).

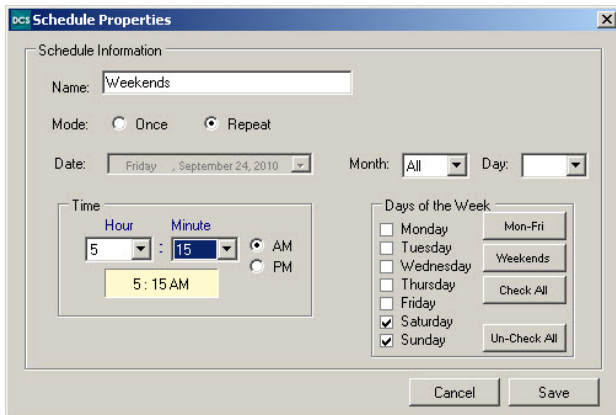
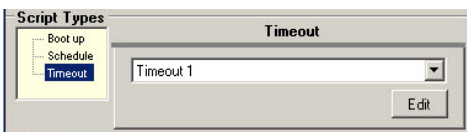

**FIG. 72** Schedule Properties window

3. Enter a name for the schedule in the Name field. This name will appear in the schedule menu on the AMX DCS window after you save the schedule.
4. Click the **Once** or **Repeat** option button to indicate how often you want the script to execute. Depending on which option you choose, perform one of the following:
  - If you select **Once**, select the date you want the script to execute from the Date menu.
  - If you select **Repeat**, use the Month and Day menus to indicate which month or day you want the script to become active. Afterward, use the Days of the Week options to indicate which days during the week you want the script to execute.
5. Use the options in the Time area to indicate the time of day when you want the script to execute.
6. Click **Save**. The scheduled script now appears in the Schedule menu on the AMX DCS window.
7. Select the schedule from the Schedule menu and create a script. When you program the device, the script will execute at the specified time.

## Creating a Timeout Script

A timeout script is the script which executes when no activity is detected on the ControlPad. You can program up to three timeouts. The timeout counter starts after the boot-up script executes.



**FIG. 73** Timeout script

Perform these steps to create a timeout script:

1. In the Script Types area, click **Timeout**. A set of options appears in the blank space within the area (FIG. 73).
2. Select one of the existing timeouts, and click **Edit**. The *Timeout Properties* dialog opens (FIG. 74).

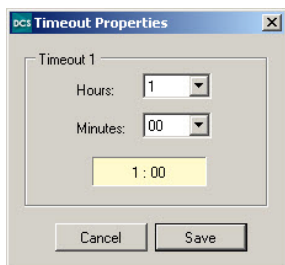
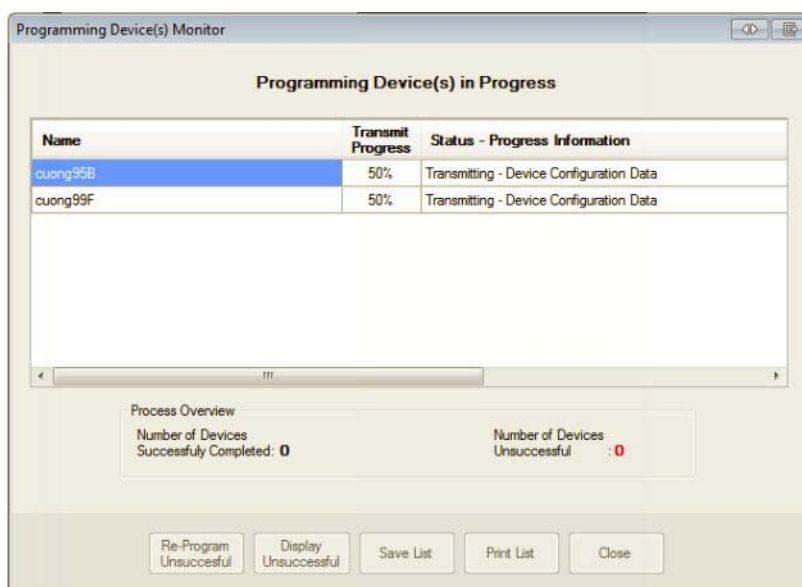

**FIG. 74** Timeout Properties dialog

3. Use the Hours and Minutes menus to indicate the length of the timeout.
4. Click **Save** to return to the AMX DCS window.
5. Select the timeout from the Timeout menu and create a script. When you program the device, the script will execute after the specified amount of time elapses without any activity on the ControlPad.

### Programming a Device

Click the Program Devices button to program configuration data and scripts to all tagged Novara devices. You can view the progress of the device update in the *Programming Device(s) Monitor* dialog (FIG. 75).



**FIG. 75** Programming Device(s) Monitor dialog

The following options appear in this dialog:

Programming Device(s) Monitor Dialog Options	
Re-Program Unsuccessful	This button is enabled if there are any unsuccessful programmed devices. Once clicked, the system attempts to re-program all unsuccessful devices in the display window.
Display Unsuccessful	Opens the <i>Programmed Unsuccessful</i> dialog which displays a list of unsuccessful programmed devices. The Print button allows you to print the list, and the Close button closes the window.
Save List	Saves the list of successful and unsuccessful items in a text file. A dialog appears to allow you to give the file a different name before saving it.
Print List	Displays the Print Preview page before allowing you to print the page.
Close	A warning displays upon closing if there are any unsuccessful devices that have not been reprogrammed. You have the option to either re-program the devices or continue to exit the programming devices window

**NOTE:** If you open a device with a script already programmed or working, but you just want to set the button setup (backlight) color, you must also re-program the script. Failure to program the script again may result in the device rebooting, and programming the device configuration without the new button setup being transmitted to the device.

1. Open the Device Configuration & Layout Inspector window (see page 30).
2. Tag any devices you want to program. You can tag as many devices as needed.
3. On the AMX DCS window, build a script using the device interface and the available options.
4. Click **Program Devices**. The *Programming Device(s) Monitor* dialog opens and displays the list of devices to be programmed. AMX DCS begins programming the device immediately.

All devices are programmed in parallel. The options at the bottom of the dialog are disabled until the updates are complete. A confirmation box appears if all updates are successful. If any updates fail, click **Re-Program Unsuccessful** to attempt the update again.

## Device Library Manager

The Device Library Manager (FIG. 76) enables you to add, import, and modify information about individual devices you can configure with DCS software. You can modify the device's serial connection settings and provide hexadecimal values, where needed, for executable and status commands. The Device Library Manager is accessible by selecting Device Library Manager from the File menu on the AMX DCS window.

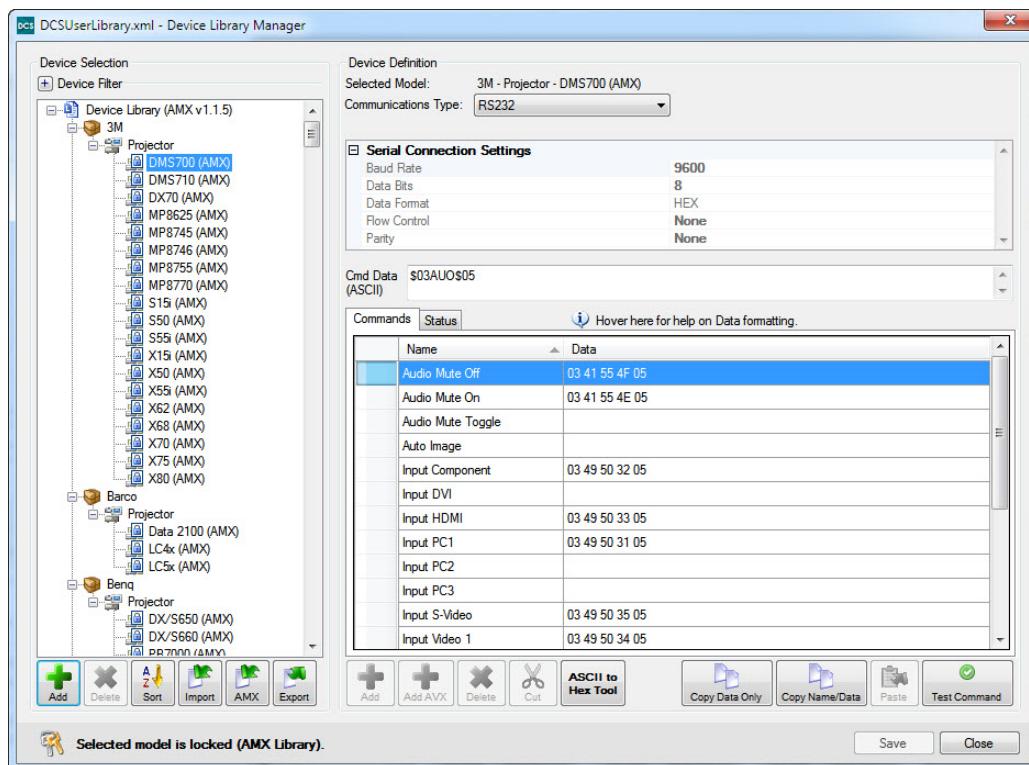

FIG. 76 Device Library Manager

**NOTE:** You can command Novara ControlPads to match only a piece of the response that comes back from a device. This ability is useful in cases where a device may send multiple responses back at one time, or may put other variable data before/after the RS-232 responses. This option is not available for the AVX-400. Since DCS is shared between the AVX-400 and the Novara ControlPads, if you modify your device library entry to use this method of partial matching, you will not get a match on the AVX-400, and will not see any values or changes to values you are monitoring.

The following options appear on the Device Library Manager window

Device Library Manager Options	
Device Selection	
Device Filter	The Device Filter option opens to reveal three filtering options to help narrow your search for a specific device. You can filter by Manufacturer, Device Type, or Communications.
Add	Add a new device to the library. The Manufacturer can be a new manufacturer or you can select a previously-defined entry from the drop-down list. Similarly, the Device Type can be a new entry or you can select a previously-defined entry from the drop-down list. Manufacturer and Device Model entries are limited to 20 characters while Device Type is limited to 40 characters. Once the device is added it will be populated and selected in the device layout.
Delete	Delete the selected device.
Sort	Sort the devices alphabetically.
Import	Allows you to import Novara or Solecis legacy library files (one-by-one) and add their device definitions to the library. You can also import a previously exported.xml library file.
AMX	Click to open a web browser which navigates to <a href="http://www.amx.com">www.amx.com</a> so you can download a device library file.
Export	Allows you to select an existing device model from the tree and export its definition to a file in .xml format. This feature allows you to share devices with others. Once exported you can import the definition and add it to the library (assuming it does not already exist).

Device Library Manager Options (Cont.)	
Device Definition	
Selected Model	The name of the selected device. This information is view-only.
Communications Type	The type of connection for the device. A different set of commands can be saved for each communication type. RS-232 communications have a commands and status section whereas Infrared has only a command section.
Serial Connection Settings	Displays the Baud Rate, Data Bits, Data Format, Flow Control, Parity, and Stop Bits for the device. You can change most of these options, if necessary. You cannot change any field that appears dimmed.
Cmd Data (ASCII)	When you select a record from the commands/status table, this field shows the ASCII representation of the data. This information is view-only, however, you can select and copy the information.
Command/Status Table	The command/status table displays all the commands/status for a selected communication type. Command/status names must be unique. Each cell in the Name and Data columns can be edited by clicking twice on the cell (once for row selection and once for editing). The table can be sorted in ascending or descending order by clicking on the Name or Data columns. In the command/status table for RS232, the data field is displayed in hex format separated by spaces. The only exception is literal values which can be present at the end of the hex string. When you click a value to edit it, the hex portion of the data transforms into ASCII. Non-printable characters remain in hex, but are appended with the '\$' character. If a literal string is present at the end of the value, it is surrounded by quotes. To define non-printable characters like OD, simply enter \$OD. To define the \$ character, enter \$\$.
Add	Adds a space for a new command in the above list. You can add the name of the command and its hexadecimal value in the Name and Data fields, respectively.
Delete	Deletes the selected command.
Cut	Removes the selected command from the command list and stores its information on the local clipboard for copying.
ASCII to Hex Tool	Opens a tool which helps convert ASCII text into hexadecimal code.
Copy Data Only	Copies the data from a selected record from the command/status table into memory. The data can then be pasted onto a command or into any model's command/status table.
Copy Name/Data	Copies a selected record from the command/status table into memory. The record can then be pasted into any model's command/status table as long as the name is unique.
Paste	Once a selected record from the command/status table is cut or copied, click this button to paste the record into any model's command/status table (provided the name is unique.)
Test Command	Click to launch the Test Command Tool so you can send commands and view feedback from the receiving device.

### Device Interrogation Formulas

When you are working with formulas for Device Interrogation, you can use the following procedure to ensure the formulas have the correct syntax:

1. Save all changes to the device library.
2. Clear and re-select the device on the interrogation feature in the AMX DCS window.
3. Select **Compile Scripts** from the Tools menu.

If the pop-up says "Compiled Successfully" it means the interrogation formulas follow the correct syntax. If an error appears, it indicates which status request or formula has an error. If multiple errors are present, only the first one encountered is shown.

The formula engine has a strict order of operations:

- The formula is read from left to right, with no parentheses allowed.
- Operators + - \* / are supported.
- When using math operators, you should enclose constants in single quotes.  
For example, <1> + '2' \* '3' / '4'.

**NOTE:** *Floating point results are not supported, and will be either truncated or rounded at the engine's discretion.*

- <#> represents the decimal value of the byte at position #. The first byte in the response is byte 1.
- &<#> represents the same as the above, but the & tells the formula engine to change the value into ASCII. So, if &<1> = 0x32 = ASCII "2", then that is what is returned to RMS.

The ControlPad can handle a maximum of 60 bytes upon receipt of a response from a projector in regards to Device Interrogation. It also polls the projector once per second for up to 5 maximum queries (if more than 5 queries are defined in the library, only the first 5 added into the library are run on the ControlPad.) The system only accepts pauses in serial RX streams of data for 100-150 milliseconds before it considers the string finished.

## Adding a Device to the Device Library

If the provided device library does not contain the device you are using, you can add the device to the library manually. Perform the following steps to add a device to the device library:

1. From the File menu, select **Device Manager Library**. The Device Library Manager window opens.
2. In the Device Selection area, click the **Add** button. The *Add Device* dialog opens (FIG. 77).

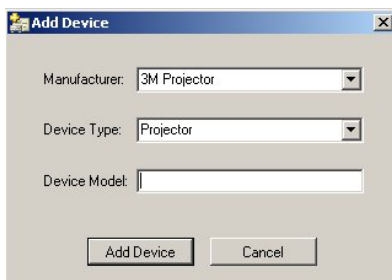

FIG. 77 Add Device dialog

3. From the Manufacturer options menu, select a device manufacturer.
4. From the Device Type options menu, select the type of device you want to add.
5. Enter the name of the device in the Device Model field.
6. Click **Add Device** to add the device to the device library.
7. Click **Save** to save the Device Library.

**NOTE:** DCS will add default fields when you create a new custom library file.

## Modifying Devices in the Device Library

To modify a device's connection and command information, perform the following steps:

1. Select the device from the Device Selection tree. Its connection and command information appears in the right pane.
2. Change the device's serial connection settings by clicking the individual option and selecting a new value from the available list.
3. For any commands that require programming, click the field under the Data column for the corresponding command, and enter the hexadecimal code required for the command. Consult the manual included with your device for more information.

Whenever a device's commands or status information is changed, and saved in the device library, you must manually update the commands in the script (delete/re-add.) In addition, you must to clear the device, and reselect it for device interrogation to work. More importantly, if you change which devices are on different serial ports for device interrogation, you should delete the device from RMS, stop the proxy, and then re-program the ControlPad. When those steps are complete, restart the proxy and re-add the ControlPad.

## Importing a Device Library

1. From the File menu, select **Device Manager Library**. The Device Library Manager window opens.
2. In the Device Selection area, click the **Import** button.
3. Navigate to a directory containing Novara device libraries (\*.xml, \*.plr, \*.pr, \*.txt) and select a library file. The Import Legacy Library dialog opens (FIG. 78).

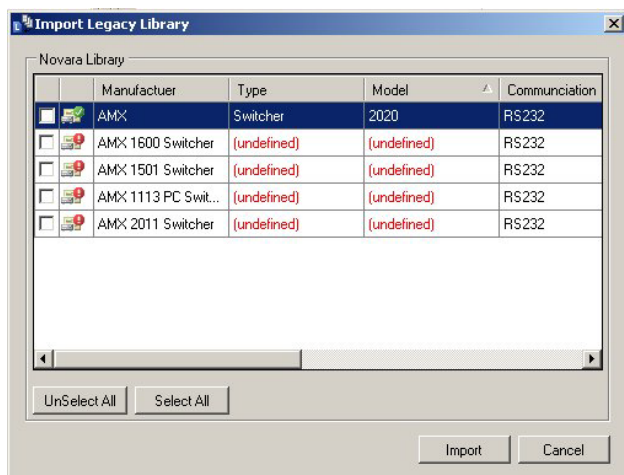

FIG. 78 Import Legacy Library dialog

4. Select the libraries you want to import, and click **Import**.



**NOTE:** If any of the fields in the device library are undefined, you must rename the device to define all fields before importing the library. See the *Renaming a Device* section on page 56 for more information.

- Click **OK** to confirm the libraries have been imported. The devices now appear in the Device Selection list.

### Renaming a Device

When importing a device library, if any of the fields in the device library are undefined, you must rename the device to define all fields before importing the library.

- Import a device library that contains undefined fields.
- Right-click the device with undefined fields, and select **Rename Device(s)**. The *Rename Device Libraries* dialog opens (FIG. 79).

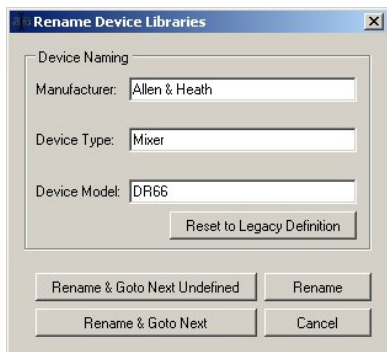
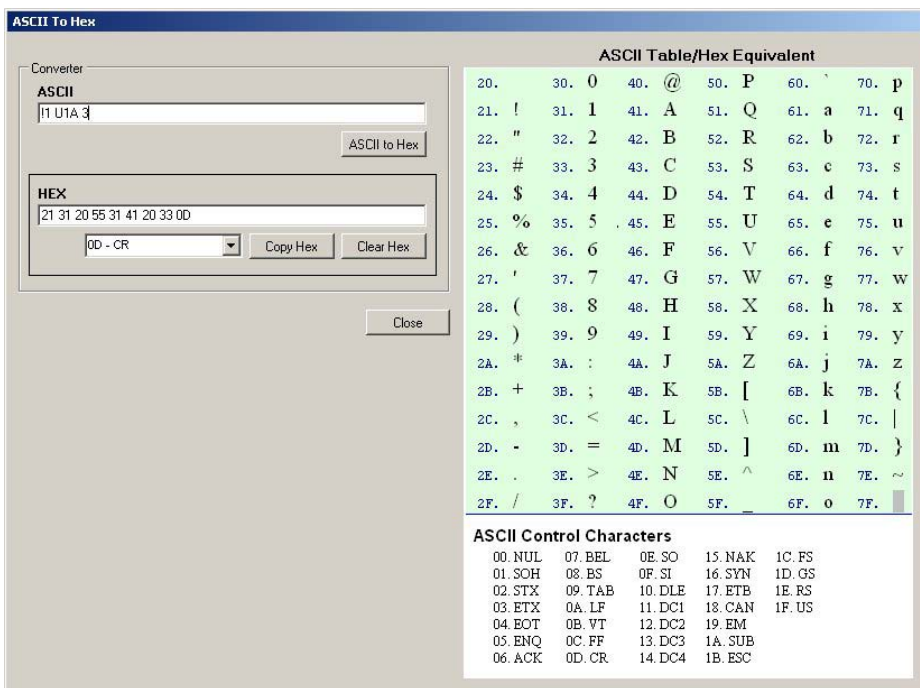

**FIG. 79** Rename Device Libraries dialog

- Enter the appropriate information in the undefined fields.
- Click **Rename**. The *Rename Device Libraries* dialog closes, and you can now import the device library.

### ASCII to Hex Tool

Use the ASCII to Hex tool to convert ASCII text to a hexadecimal value for device commands.



**FIG. 80** ASCII to Hex window

The following options appear in this window:

ASCII to Hex Window Options	
ASCII	Enter ASCII text in this field.
ASCII to Hex button	Click this button to convert the ASCII text to Hex.
HEX	Displays the Hex equivalent of the ASCII text.
Add Control Characters	Select an ASCII control character from the menu to add it to the HEX field. A list of ASCII control characters appears on the bottom right of the screen.
Copy Hex	Click to copy the Hex value into memory.



ASCII to Hex Window Options (Cont.)	
Clear Hex	Click to clear the HEX field.
Close	Click to close the window.

Perform the following steps to use the ASCII to Hex tool:

1. Enter text in the ASCII field.
2. Click **ASCII to Text**. The hexadecimal version of the text appears in the HEX field.
3. Click **Copy Hex** to copy the hexadecimal text to the clipboard.
4. Click **Close** to return to the Device Library Window.
5. Select a command, and click **Paste** to insert the data into the command/status table.

### Test Command Tool

The Test Command Tool enables you to test a created command by sending the commands directly to a display device that is directly connected to the PC via serial port. When using the Test Command Tool, you can send commands and view feedback from the receiving device.

**NOTE:** To use this tool, you must directly connect the SERIAL port on your PC to the device. See the RS-232 section on page 17 for wiring and connection information.

FIG. 81 displays the Test Command Tool (*Send Command thru COM to Device* window).

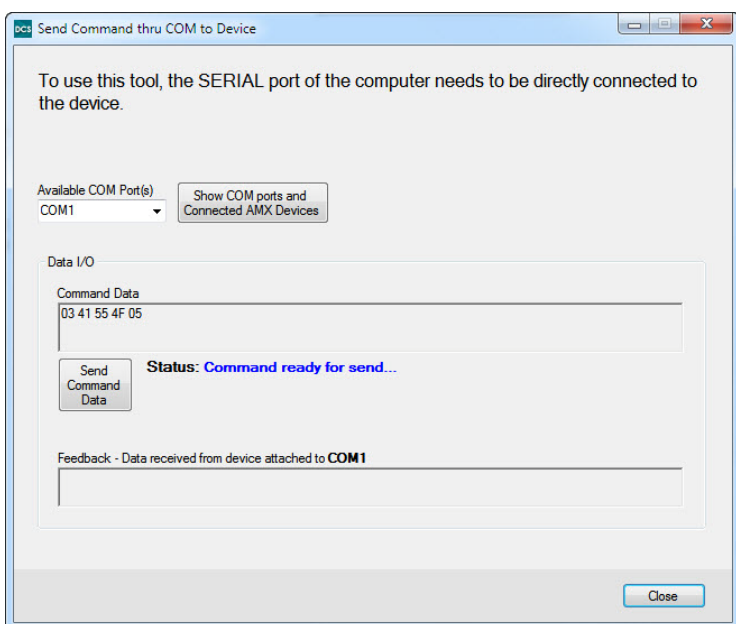

FIG. 81 Test Command Tool

The following options appear in this window:

Test Command Tool Options	
Available COM Port(s)	The available ports on the connected device. Click the Show COM ports and Connected AMX Devices button to refresh the list of available ports.
Show COM Ports and Connected AMX Devices	Click to refresh the list of available COM ports.
Command Data	The command data in hexadecimal format to the send to the device. This data is copied from the Data column for the command in the Device Library Manager. You cannot change this data from this window. You can only change it from the Device Library Manager.
Send Command Data	Click to send the command data to the connected device.
Feedback	This area displays any feedback received from the receiving device.
Close	Click to close the window.

### Using the Test Command Tool

1. Open the Device Library Manager.
2. Select a device, then select a command for the device.
3. Click **Test Command**. The Test Command Tool opens.
4. Select the COM port on the PC which is connected to the device to which you want to send the test command.

- Click **Send Command Data** to transmit the command data to the device. Any information returned from the device appears in the Feedback area.

## Updating Firmware

AMX DCS software provides a simple interface for updating your 3000-Series ControlPads with the latest available version of firmware. You must use a Novara CP3000 Firmware Data File (.out) to upgrade the firmware through AMX DCS software. The latest firmware files can be found at the Tech Center at [www.amx.com](http://www.amx.com). Perform these steps to update the firmware on your ControlPad:

- Open the Device Configuration & Layout Inspector window (see page 30).
- Tag any devices that need a firmware upgrade in the Device Layout. You can tag as many devices as needed. You cannot tag any devices in the Devices Found on Network list. If you want to upgrade the firmware of an unbound device, you must first add it to the Device Layout.
- On the AMX DCS window, click **Firmware Upgrade**.
- Select a firmware file (.out) from the dialog that appears, and click **OK**. The *Programming Device(s) Monitor* dialog appears (FIG. 82).

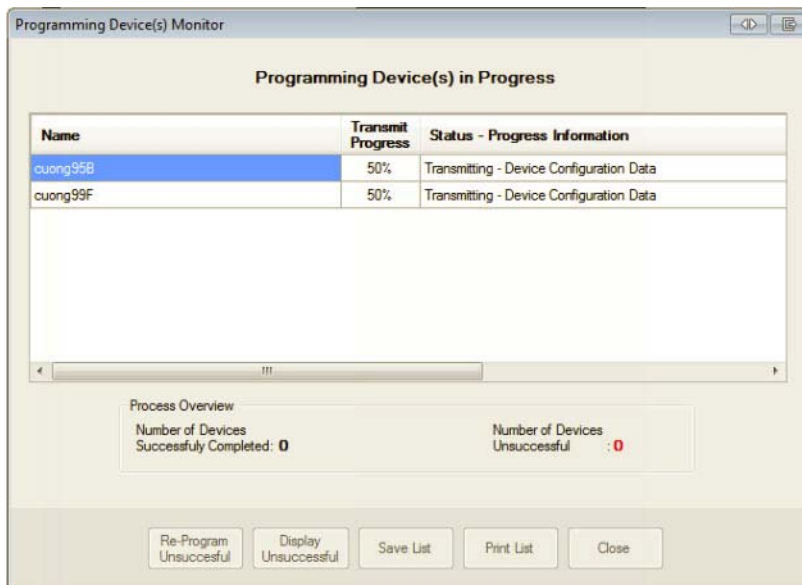

**FIG. 82** Programming Device(s) Monitor dialog

All firmware updates are programmed in parallel. The options at the bottom of the dialog are disabled until the updates are complete. A confirmation box appears if all updates are successful. If any updates fail, click **Re-Program Unsuccessful** to attempt the upgrade again.

If you are updating to firmware version 1.2 or higher and the current device uses a version lower than 1.2, the firmware update is split into two processes. The first process updates the firmware, and the second process updates the web page files. Follow the on-screen instructions to complete the second process.

**NOTE:** When you upgrade a ControlPad from a 1.0 version of firmware to a 1.2 version of firmware, the firmware must be upgraded two times. DCS normally prompts you to perform both upgrades. If you do not run the upgrade two times, the Web Console will not be available. Additionally, whenever a 1.2 version of firmware is upgraded, you **MUST** wait 2 minutes before attempting to program the ControlPad. This is true even if DCS says the firmware update is complete. The ControlPad sends the "complete" message to DCS before it has actually unpacked the web pages, and the board will be online (and could be programmed) while this unpacking is ongoing. You should not program, or press buttons physically, via the web, or via RMS during this time.

**NOTE:** During a firmware upgrade, the ControlPad runs sluggishly, and may skip scripted events and/or appear offline to RMS. You should only perform a firmware upgrade when the ControlPad is not in use, and no scheduled events or macros are set to run from RMS enabled ControlPads.

**NOTE:** If you need to downgrade the firmware from a 1.2.xx version to a 1.0.xx version, you must remove any scripting pertaining to options only available in version 1.2.xx and above. Your scripts cannot contain interrogation data or any configuration data including Bank, Toggle, Disable Schedule, or Volume LED from a 1.2.xx code release. Running scripts with these features on 1.0.xx firmware may cause errors with your ControlPad which can only be resolved by pressing the Reset button on the ControlPad and rebooting the system.

**NOTE:** If you are using Windows 7 Home Premium, 32-bit, US English version, you may experience an incomplete firmware upgrade. If this occurs, you can perform a complete firmware upgrade by disabling your firewall. You can re-enable the firewall after the firmware upgrade is complete.

# Web Console

## Overview

All CP-3000 ControlPads can use web pages for monitoring and limited control of the ControlPads. These pages will only be available if the web page capability has been enabled through DCS. See the *Configuring Global Settings* section on page 33 for more information. You can access the web pages by entering the IP address of a ControlPad in a web browser. After entering a valid username and password, you can use the web pages to view device information or remotely execute button presses. FIG. 83 displays the login page.

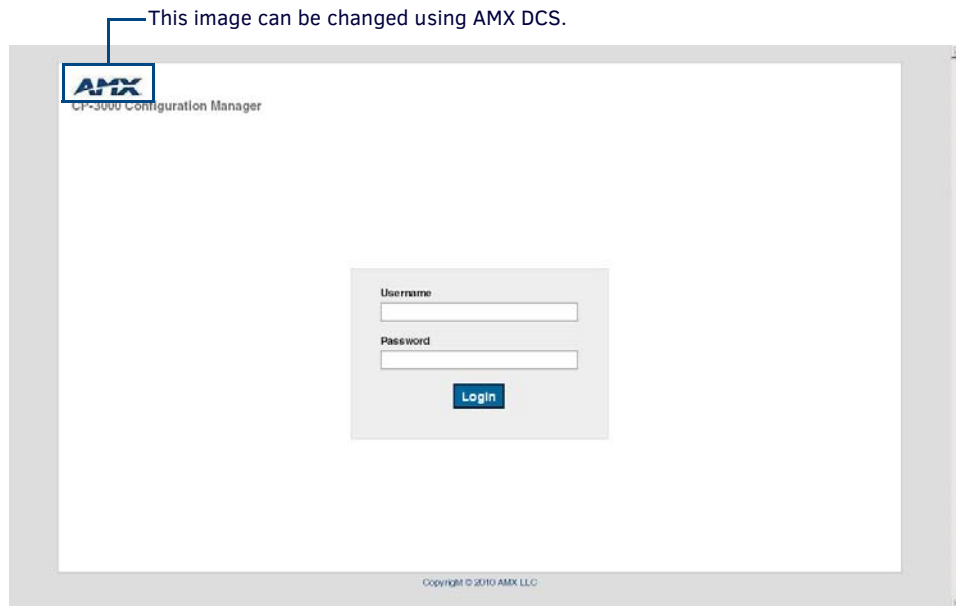

**FIG. 83** Login page

The default username is **admin** and the default password is **1988**.

### Changing the Image Logo on the Web Pages

AMX DCS contains a feature which enables you to add a logo or image file (.jpg, .gif, .png) which appears on each page. The image cannot be greater than 7 kilobytes in size. If the file is greater than 7 kilobytes, you will receive a notification that the file is too large and must be reduced in size before you can use it. Perform these steps to change the image logo on the web pages:

1. Open AMX DCS. See the *Device Configuration Software* section on page 28 for more information.
2. Click **Project Device Config** to open the Device Configuration Layout & Inspector window.
3. Click **Global Settings**. The Configure Global Device Settings window opens.
4. Click **Web**.
5. Click **Select Image**. A *Browse* dialog opens which you can use to navigate to the image file you want to use. Click **OK** after selecting the appropriate file.
6. Click **Download logo to device**.

## Device Information Page

The Device Information page displays information about the device such as device name and IP address. You cannot change any of the information on this page. However, you can reboot the ControlPad by clicking Reboot. FIG. 84 displays the Device Information page.

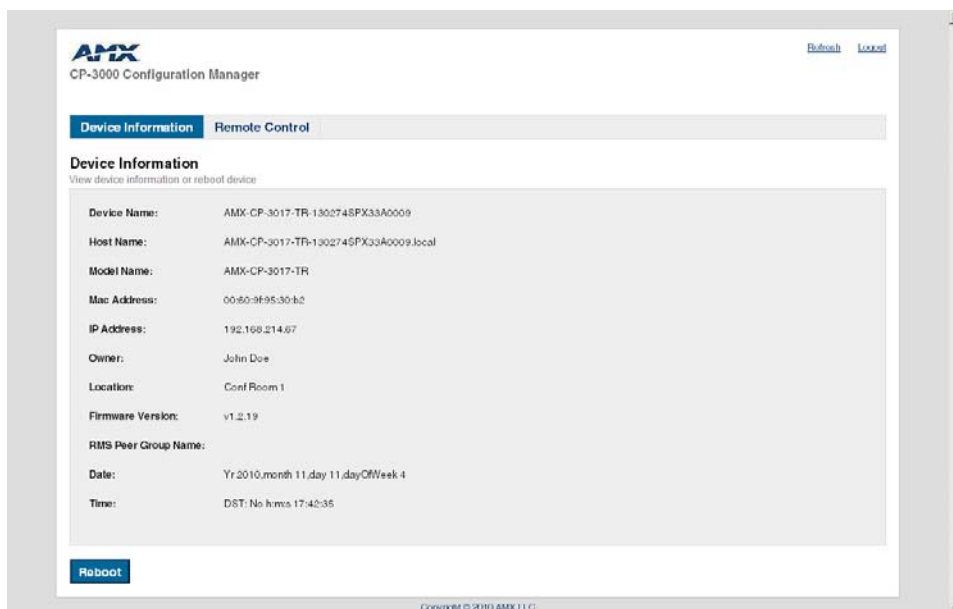

FIG. 84 Device Information page

## Remote Control Page

The Remote Control page enables you to remotely execute button presses from a web page. The page provides a list of all buttons on the ControlPad with an available script. Both physical and virtual with scripts are listed. On the web page, buttons on the page act like regular buttons in that a mouse button click represents a button press, and a mouse button release represents a button release. The web page enables you to activate press, release, and press-and-hold events that are programmed for each button on the ControlPad. FIG. 85 displays the Remote Control page.

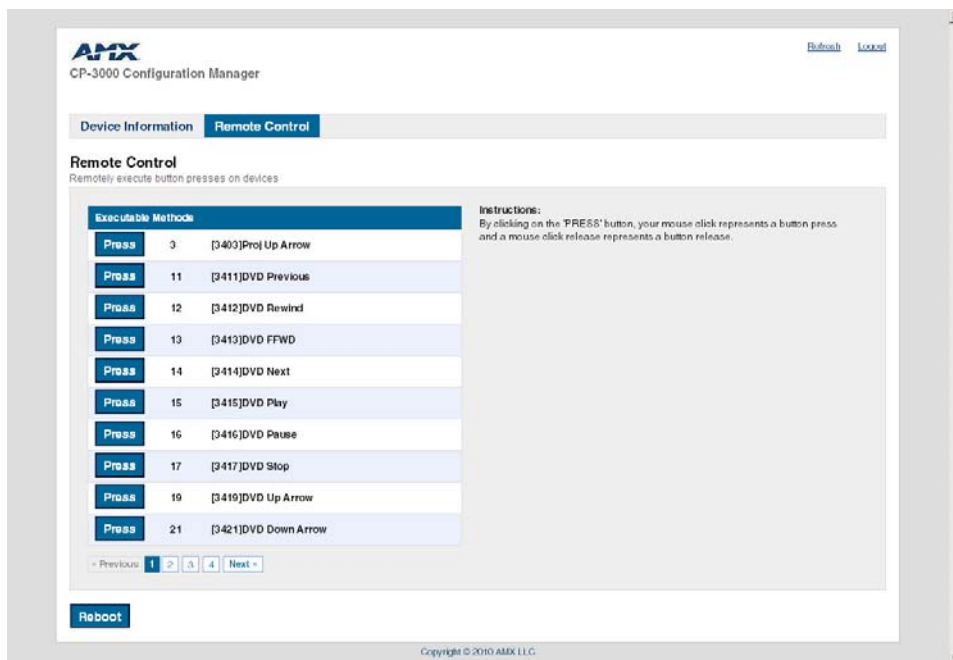

FIG. 85 Remote Control page

# RMS Configuration

## Overview

NOVARA 3000-series ControlPads can connect to a Resource Management Suite® (RMS) server to view online status, execute control functions, create macros containing those control functions, and schedule the execution of the macros. Connecting to RMS involves installing a proxy, called the CP-RMS application, directly onto the RMS server or on a PC. The proxy serves as a gateway between the ControlPads and the RMS server. There is no user interface available for the proxy, so when the proxy is installed on a PC, you must use telnet to view the proxy debug logs. The CP-RMS is a service that you must manually start after you install and configure it. Afterward, it automatically starts if you reboot the PC.

**NOTE:** *The CP-RMS proxy is designed to work with RMS 3.3 or higher and requires you have the latest version of Java loaded on your PC. The CP-RMS proxy is intended for use with 32-bit servers only. When upgrading the CP-RMS proxy, you should always shut down the CP-RMS proxy service prior to upgrading.*

The following table lists the operating systems compatible with the CP-RMS application:

Supported Operating Systems	
• Windows Server 2003 English	• Windows Server 2008 Italian
• Windows Server 2003 German	• Windows Server 2008 Dutch
• Windows Server 2003 Italian	• Windows Server 2008 French
• Windows Server 2008 English	• Windows Server 2008 Spanish
• Windows Server 2008 German	

## Installation Checklist

CP-RMS Proxy Installation Checklist
• Ensure you have the latest version of Java installed on the RMS server or the PC.
• Install the CP-RMS application using the CPRMS.msi file and follow the installation instructions.
• Edit the config.properties file to include the default RMS server IP address, the proxy telnet port, and the proxy telnet debug level.
• Edit the config.properties file to add the IP addresses of any ControlPads you want to track in RMS. <i>Note: Your zero-configuration client automatically discovers any ControlPads residing on the same subnet as your CP-RMS application. This step is only necessary if you want the ControlPads to use static IP addresses, or the ControlPads are on a different subnet from the CP-RMS application.</i>

## Installing the CP-RMS Proxy

Perform these steps to install the CP-RMS proxy:

1. Double-click the CPRMS.msi file to open the AMX CP-RMS Service Setup Wizard (FIG. 86).



**FIG. 86** AMX CP-RMS Service Setup Wizard

2. Click **Next**.
3. The next screen in the Installation Wizard enables you to change the installation folder (FIG. 87). Click **Browse** to navigate to a new folder, or click **Next** to accept the default location.

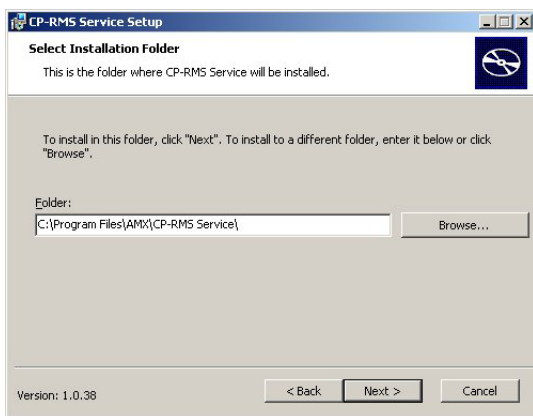

**FIG. 87** Select Installation Folder

4. On the next screen, click **Install**. The CP-RMS Service begins to install.
5. Click **Finish** when the installation is complete.

### Upgrading the CP-RMS Proxy

If you are upgrading the existing version of the CP-RMS proxy, perform the following:

1. Shut down the existing CP-RMS service.
2. Make a backup of the config.properties file.
3. Perform the upgrade.
4. When the installation is complete, restore the backup copy of the config.properties file to the installation folder of the proxy.

**NOTE:** If you do not have the `enabletelnet` parameter in your `config.properties` file, you can add it to the file before restoring the backup copy. This parameter turns on or turns off telnet access with CP-RMS Proxy Build 1.0.54 or later. Set the parameter to 1 for enable and 0 for disable.

5. Restart the proxy.

### Editing the Configuration File

The `config.properties` file enables you to edit the configuration file for the CP-RMS application to include the default RMS Server IP address, the peer group, and the IP addresses of any ControlPads residing on a different subnet or ControlPads you wish to statically define. You can also define the telnet information needed for accessing the CP-RMS application from a PC. The file is typically located in the

`C:\Program Files\AMX\CP-RMS` directory on the PC on which the CP-RMS application is running.

You can open the file with any text editor program. Once you make changes to and save the file, you must start the CP-RMS service. FIG. 88 displays an example of the configuration file.

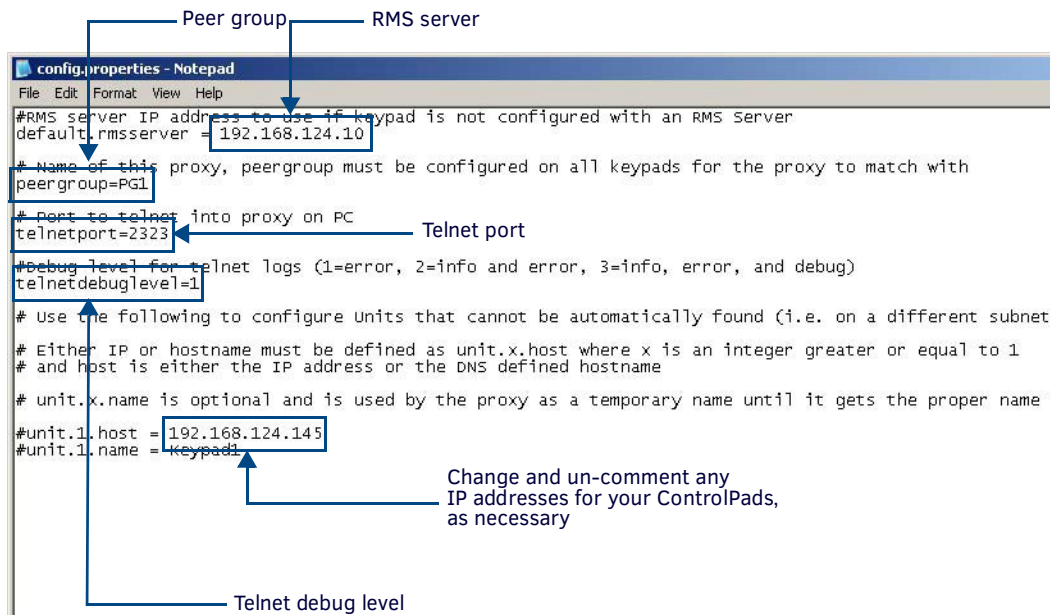

**FIG. 88** Configuration file

Perform these steps to edit the configuration file:

1. Using the PC on which the RMS proxy is installed, navigate to the location of the *config.properties* file (usually *C:\Program Files\AMX\CP-RMS*.)
2. Open the file with a Text Editor program like Notepad.
3. Change the default RMS server. This value is required for use if the ControlPad is not configured with an RMS server in AMX DCS. See the *Configuring Global Settings* section on page 33 for more information.
4. Change the telnet port to the port you want to use to telnet into the proxy. You can telnet into the proxy on the same PC it is running on by using the loopback IP address (127.0.0.1).
5. Change the value of the peer group. This is a user defined name for the proxy. You must configure this value on the proxy and on all ControlPads which the proxy uses zero configuration to discover. You can configure this value on the ControlPads in the global or device settings using AMX DCS. See the *Configuring Global Settings* section on page 33 for more information.
6. Change the telnet debug level to the desired setting. This setting indicates the type of information that is reported to the telnet log. Set it to 1 for errors only, 2 for information and errors, or 3 for information, errors, and debug information.
7. Enable or disable telnet by adding *enabletelnet=0* to the configuration file. Set 1 for enable and 0 for disable.
8. Add any IP addresses or hostnames for ControlPads residing on a different subnet than the proxy, or any ControlPads you want to statically configure.
9. Save the file.

### Starting the CP-RMS Service

After editing and saving the *config.properties* file, you must start the CP-RMS Service (Administrative Tools>Services). If you need to change the *config.properties* file at a later date, you must restart the CP-RMS Service for any changes to take effect.

When you configure the peer group on a ControlPad, you must restart the proxy after the ControlPad comes back online for the proxy to get an updated beacon and match peer groups.

For first time installations, you should program and configure all ControlPads that connect to a proxy using a zero-configuration client before starting the CP-RMS Service. If you are using a zero-configuration client, and the IP address of the ControlPad is changed for any reason (for example, the DHCP server assigns a different IP upon reboot of the ControlPad), the CP-RMS Service needs to be restarted for it to update the ControlPad's IP address.

**NOTE:** *If you add a ControlPad as a room in RMS, and then change the device name on the ControlPad to display updated information regarding the device name, you must delete the room in RMS and re-add it for the changes to appear.*

### RMS Control Functions and Macros

When a ControlPad connects to RMS, all physical and virtual buttons that have been programmed properly with scripts and Button Assigned Names using AMX DCS display as available control functions in RMS (see the *Button Actions and Events* section on page 49 for more information). These control functions are available for inclusion in macros. You can schedule the macros to execute by using the RMS Internal Scheduler or an external scheduler.

When you execute a button press on the ControlPad, physically or through RMS, the script that is programmed for that button executes. The ControlPad only runs one script at a time, so if it is busy running a script and a new button event is received, the button event is ignored.

The most efficient way to execute multiple events in one macro through RMS is to create a virtual button that contains all desired events. When programming the keypad through DCS, make sure to select one of the existing RMS standard functions from the Button Assigned Name options menu or create a custom name for the virtual button. This virtual button then appears in RMS as a control function and you can create and schedule a macro, containing only that control function, in RMS.

### Device Interrogation

If you program a ControlPad for device interrogation, and later re-program the ControlPad, but add a new input on a device, you must not only clear the device, re-select it, and reprogram the ControlPad from DCS, but you also need to delete the ControlPad from RMS, and restart the proxy to guarantee that the new inputs show up in the notification menus and the status is shown in the RMS server.

When the ControlPad boots up, it only runs device interrogation after the CP-RMS Proxy successfully connects to it. Additionally, the ControlPad only sends values to the CP-RMS proxy on the initial connection, and when they update. This means that for formula results, the result of the formula calculation must change at the integer/whole number level. If a device was returning lamp hours as seconds, and the formula converts seconds to hours, then the final integer result must increment or decrement to update the proxy, and ultimately RMS Server.

If a device goes offline or fails to respond to the ControlPad Status Query, no update is sent since the device is in an unknown state. A device which has lost power, or has had a disconnected serial cable, will appear online, but will never update its status.



© 2016 Harman. All rights reserved. Novara, NetLinx, AMX, AV FOR AN IT WORLD, HARMAN, and their respective logos are registered trademarks of HARMAN. Oracle, Java and any other company or brand name referenced may be trademarks/registered trademarks of their respective companies. AMX does not assume responsibility for errors or omissions. AMX also reserves the right to alter specifications without prior notice at any time. The AMX Warranty and Return Policy and related documents can be viewed/downloaded at [www.amx.com](http://www.amx.com).  
**3000 RESEARCH DRIVE, RICHARDSON, TX 75082 AMX.com | 800.222.0193 | 469.624.8000 | +1.469.624.7400 | fax 469.624.7153**  
**AMX (UK) LTD, AMX by HARMAN - Unit C, Auster Road, Clifton Moor, York, YO30 4GD United Kingdom • +44 1904-343-100 • [www.amx.com/eu/](http://www.amx.com/eu/)**

Last Revised:  
6/10/2016