

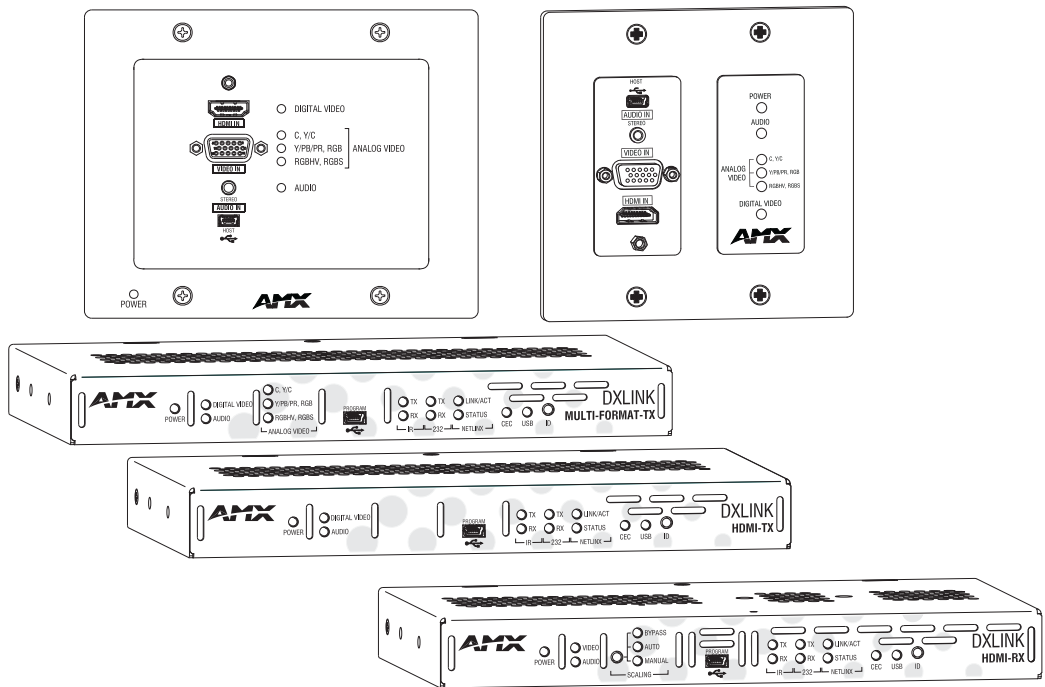

HARDWARE REFERENCE MANUAL

DXLINK™ TWISTED PAIR TRANSMITTERS/RECEIVER

DX-TX, DX-TX-WP, DX-TX-DWP, DX-RX, AVB-TX-HDMI-DXLINK



IMPORTANT SAFETY INSTRUCTIONS

1. READ these instructions.
2. KEEP these instructions.
3. HEED all warnings.
4. FOLLOW all instructions.
5. DO NOT use this apparatus near water.
6. CLEAN ONLY with dry cloth.
7. DO NOT block any ventilation openings. Install in accordance with the manufacturer's instructions.
8. DO NOT install near any heat sources such as radiators, heat registers, stoves, or other apparatus (including amplifiers) that produce heat.
9. DO NOT defeat the safety purpose of the polarized or grounding type plug. A polarized plug has two blades with one wider than the other. A grounding type plug has two blades and a third grounding prong. The wider blade or the third prong are provided for your safety. If the provided plug does not fit into your outlet, consult an electrician for replacement of the obsolete outlet.
10. PROTECT the power cord from being walked on or pinched, particularly at plugs, convenience receptacles, and the point where they exit from the apparatus.
11. ONLY USE attachments/accessories specified by the manufacturer.



12. USE ONLY with a cart, stand, tripod, bracket, or table specified by the manufacturer, or sold with the apparatus. When a cart is used, use caution when moving the cart/apparatus combination to avoid injury from tip-over.
13. UNPLUG this apparatus during lightning storms or when unused for long periods of time.
14. REFER all servicing to qualified service personnel. Servicing is required when the apparatus has been damaged in any way, such as power-supply cord or plug is damaged, liquid has been spilled or objects have fallen into the apparatus, the apparatus has been exposed to rain or moisture, does not operate normally, or has been dropped.
15. DO NOT expose this apparatus to dripping or splashing and ensure that no objects filled with liquids, such as vases, are placed on the apparatus.
16. To completely disconnect this apparatus from the AC Mains, disconnect the power supply cord plug from the AC receptacle.
17. Where the mains plug or an appliance coupler is used as the disconnect device, the disconnect device shall remain readily operable.
18. DO NOT overload wall outlets or extension cords beyond their rated capacity as this can cause electric shock or fire.



The exclamation point, within an equilateral triangle, is intended to alert the user to the presence of important operating and maintenance (servicing) instructions in the literature accompanying the product.



The lightning flash with arrowhead symbol within an equilateral triangle is intended to alert the user to the presence of uninsulated "dangerous voltage" within the product's enclosure that may be of sufficient magnitude to constitute a risk of electrical shock to persons.



ESD Warning: The icon to the left indicates text regarding potential danger associated with the discharge of static electricity from an outside source (such as human hands) into an integrated circuit, often resulting in damage to the circuit.

- WARNING:** To reduce the risk of fire or electrical shock, do not expose this apparatus to rain or moisture.
- WARNING:** No naked flame sources - such as candles - should be placed on the product.
- WARNING:** Equipment shall be connected to a MAINS socket outlet with a protective earthing connection.
- WARNING:** To reduce the risk of electric shock, grounding of the center pin of this plug must be maintained.

COPYRIGHT NOTICE

AMX© 2015, all rights reserved. No part of this publication may be reproduced, stored in a retrieval system, or transmitted, in any form or by any means, electronic, mechanical, photocopying, recording, or otherwise, without the prior written permission of AMX. Copyright protection claimed extends to AMX hardware and software and includes all forms and matters copyrightable material and information now allowed by statutory or judicial law or herein after granted, including without limitation, material generated from the software programs which are displayed on the screen such as icons, screen display looks, etc. Reproduction or disassembly of embodied computer programs or algorithms is expressly prohibited.

LIABILITY NOTICE

No patent liability is assumed with respect to the use of information contained herein. While every precaution has been taken in the preparation of this publication, AMX assumes no responsibility for error or omissions. No liability is assumed for damages resulting from the use of the information contained herein. Further, this publication and features described herein are subject to change without notice.

AMX WARRANTY AND RETURN POLICY

The AMX Warranty and Return Policy and related documents can be viewed/downloaded at www.amx.com.

WARNING: This product is intended to be operated ONLY from the voltages listed on the back panel or the recommended, or included, power supply of the product. Operation from other voltages other than those indicated may cause irreversible damage to the product and void the products warranty. The use of AC Plug Adapters is cautioned because it can allow the product to be plugged into voltages in which the product was not designed to operate. If the product is equipped with a detachable power cord, use only the type provided with your product or by your local distributor and/or retailer. If you are unsure of the correct operational voltage, please contact your local distributor and/or retailer.

EU COMPLIANCE INFORMATION:

Eligible to bear the CE mark; Conforms to European Union Low Voltage Directive 2006/95/EC; European Union EMC Directive 2004/108/EC; European Union Restriction of Hazardous Substances Recast (RoHS2) Directive 2011/65/EU; European Union WEEE (recast) Directive 2012/19/EU; European Union Eco-Design Directive 2009/125/EC; European Union Registration, Evaluation, Authorization and Restriction of Chemicals (REACH) Directive 2006/121/EC.

You may obtain a free copy of the Declaration of Conformity by visiting <http://www.amx.com/techcenter/certifications.asp>.

WEEE NOTICE:



This appliance is labeled in accordance with European Directive 2012/19/EU concerning waste of electrical and electronic equipment (WEEE). This label indicates that this product should not be disposed of with household waste. It should be deposited at an appropriate facility to enable recovery and recycling.

US FCC COMPLIANCE NOTICE – CLASS A

NOTE: *This equipment has been tested and found to comply with the limits for a Class A digital device, pursuant to part 15 of the FCC Rules. These limits are designed to provide reasonable protection against harmful interference when the equipment is operated in a commercial environment. This equipment generates, uses, and can radiate radio frequency energy, and if it is not installed and used in accordance with the instruction manual, it may cause harmful interference to radio communications. Operation of this equipment in a residential area is likely to cause harmful interference, in which case the user will be required to correct the interference at his own expense.*

US FCC AND CANADA EMC COMPLIANCE INFORMATION:

This device complies with part 15 of the FCC Rules. Operation is subject to the following two conditions:

- (1) This device may not cause harmful interference, and (2) this device must accept any interference received, including interference that may cause undesired operation.

CANADA ICES INFORMATION

ICES (Interference-Causing Equipment Standard): CAN ICES-3 (A)/NMB-3(A)

LICENSE NOTICES AND TRADEMARK ACKNOWLEDGMENTS

Windows® and Internet Explorer® are registered trademarks of Microsoft Corporation in the United States and other countries.

UL® and the UL logo are trademarks of UL LLC.

Ethernet® is a registered trademark of the Xerox Corporation.

ENERGY STAR® is a registered trademark of the U.S. Department of Energy and the U.S. Environmental Protection Agency.

Other products mentioned herein may be the trademarks of their respective owners.

CONTENTS

- Product Overview and Specifications 7**
 - Applicability Notice 7
 - Product Notes 7
 - Product Compatibility Tables 8
 - DXLink Transmitter and Receiver Features 9
 - Common Applications 9
 - Transmitters 10
 - Receiver 15
 - Common Features/Functionality 17
 - Quick Reference Tables for Modes 20
- Installation and Setup 27**
 - Site Recommendations 27
 - General Hazard Precautions 27
 - Setup Information 27
 - Wallplate Transmitters – Attaching Signal/Transport Cables 42
 - DX-TX or HDMI TX – Attaching Signal, Transport, and Control Cables 44
 - DX-TX or HDMI TX – Applying Power 44
 - DX-RX – Attaching Signal and Control Cables 45
 - DX-RX – Applying Power 46
 - Serial Data Transfer and IR Flow Control 47
 - Optional: DX-TX, HDMI TX, and DX-RX – Wiring for Serial Data Transfer 47
 - Optional: DX-TX, HDMI TX, and DX-RX – IR Control 48
 - ID Pushbutton Functions 49
 - DX-RX Scaling Button and Scaling Modes 49
 - Detailed NetLinx (Link/Act and Status) LED Behavior 50
 - DXLink TX/RX in a Multiple-Stage Switching System 51
- Network Configuration 52**
 - Overview 52
 - Static IP Mode – Default Parameters 52
 - DHCP Mode 52
 - TCP/IP Address Configuration 53
 - Offline Recovery Mechanism for DXLink Devices 54
 - Factory Default Parameters 55
 - Device IDs 56
 - Using the ID Pushbutton 56

- IRL File Transfers 60**
 - Overview 60
 - Preparing for IRL File Transfers 61
 - Transferring IRL Files 62
- NetLinx Programming of DXLink Transmitters and Receivers 64**
 - Overview 64
 - Device Numbering and Ports 64
 - CHANNELS 65
 - DXLink Receiver Video SEND_COMMANDS 66
 - DXLink Receiver Audio SEND_COMMANDS 68
 - DXLink Transmitter Video SEND_COMMANDS 68
 - DXLink Transmitter Audio SEND_COMMANDS 72
 - IR SEND_COMMANDS 73
 - Serial SEND_COMMANDS 76
 - DXLink Transmitter USB SEND_COMMANDS 77
 - DXLink Receiver USB SEND_COMMANDS 78
 - Common DXLink Transmitter / Receiver SEND_COMMANDS 78
 - DXLink System SEND_COMMANDS 79
 - SEND_STRING Escape Sequences 81
 - Enova DVX Switchers – DXLink SEND_COMMANDS 82
- Troubleshooting 83**
 - Overview 83
 - Basic Troubleshooting 83
 - Determining HDCP Compliance 83
 - Power Issues 83
 - DXLink Connection Issues 84
 - Network Setup Issues 85
 - Technical Support 86
- Appendix A - Upgrading the Firmware 87**
 - Overview 87
 - Preparing for KIT File Transfers 88
 - Important Upgrade Information 88
 - Transferring KIT Files 90
- Appendix B - Telnet (Terminal) Commands 91**
 - Establishing a Terminal Connection Via Telnet 91
 - Telnet Username and Password 92
 - Telnet Commands 93

- Master Connection Modes..... 98
- Notes on Specific Telnet Clients..... 99
- Appendix C - Virtual NetLinx Master 100**
 - Overview Virtual NetLinx Master (Masterless)..... 100
 - Setting PC to Static IP Address 100
 - Creating a Virtual Master 101
 - Preparing a DXLink Unit to Work with a Virtual Master..... 102
- Appendix D – Cable Details and Pinout Info 104**
 - Overview 104
 - HDMI Connector Cable Pinout..... 104
 - HD-15 Connector Cable Pinout 105
 - DVI Pinout for DVI-to-HDMI Cable Adapter..... 106
- Appendix E - Supported Input Resolutions 107**
 - Available Pixel Display and Refresh Rate 107
- Appendix F - Supported Output Resolutions 110**
 - HDMI and DVI Supported Output Resolutions 110
 - Digital Video Output Resolution Support 111
- Appendix G - Ground Wire Attachment 115**
 - Applicability 115
 - Attaching a Ground Wire to a Common Earthed Ground 115
 - Attaching a Ground Wire to Module without Designated Ground..... 115
- Appendix H - EDID Programming 117**
 - DGX Configuration Software Overview..... 117
 - Software Installation on PC..... 117
 - DXLink Connection to PC 117
 - EDID Programmer View 119

Product Overview and Specifications

Applicability Notice

The information in this manual applies to the DXLink Multi-Format Transmitter Module, the DXLink HDMI Transmitter Module, the DXLink Multi-Format Wallplate Transmitter, the DXLink Multi-Format Decor Style Wallplate Transmitter (US), and the DXLink HDMI Receiver Module listed in the table below. In this manual, these products will be referred to as the DX-TX, HDMI TX, Wallplate TX, Decor Wallplate TX, and the DX-RX. When referring to all four of the transmitter units, the term Transmitters will be used.

DXLink™ Twisted Pair Transmitters and Receiver

Part #	Model Name	Model Number, Description
FG1010-310	DXLink Multi-Format Transmitter Module	DX-TX, DXLINK MULTI-FORMAT TX
FG1010-300*	DXLink HDMI Transmitter Module	AVB-TX-HDMI-DXLINK, DXLINK HDMI HDCP TX
FG1010-320-BL FG1010-320-WH	DXLink Multi-Format Wallplate Transmitter	DX-TX-WP, DXLINK MUTI-FORMAT WALLPLATE TX (BLACK or WHITE)
FG1010-325-BL FG1010-325-WH	DXLink Multi-Format Decor Style Wallplate Transmitter (US)	DX-TX-DWP, DXLINK MULTI-FORMAT DECOR STYLE WALLPLATE TX (BLACK or WHITE)
FG1010-500	DXLink HDMI Receiver Module	DX-RX, DXLINK HDMI RX

* The DXLink HDMI TX Module has been discontinued. This manual contains information on it for support. All of the features previously available in this product are currently available in the DX-TX Module.

COMPATIBILITY NOTE: *The Transmitters and the Receiver listed above are compatible with a number of other DXLink products (see the section "Product Compatibility Tables" on page 8). All of the Transmitters are compatible with the Receiver. The Wallplate TX and Decor Wallplate TX must use DXLink power injectors when connecting directly to a DX-RX; others may cause damage. Also note that TX and RX compatibility with Enova DGX DXLink boards applies when the boards are used in Enova DGX 8/16/32/64 enclosures and in Enova DGX 100 Series enclosures.*

Product Notes

The Transmitters and Receiver are designed for transmission of an HDMI signal over twisted pair cable (or a DVI signal via a DVI-to-HDMI cable adapter) up to 328 feet (100 m). Functionality is briefly described below.

DX-TX – The DX-TX receives an HDMI signal or analog video signal (composite, Y/C, Y/Pb/Pr, RGB, RGBS, or RGBHV) and an audio signal from a source device. The audio can be either digital audio embedded with the HDMI signal, digital audio over S/PDIF, or analog stereo audio.

Either analog or digital video is transmitted out of the DXLink output. The active video selection is made using one of two methods: 1) Automatic, which selects digital video as the priority video input or analog video when no digital video is present. 2) Active ICSP command video input selection from a bound NetLinX Central Controller.

Both the video and audio are transported over twisted pair cable to an Enova DGX Digital Media Switcher, an applicable Enova DVX Solution (to a DX-RX), or directly to a DX-RX.

The 232 port (RS-232) on the DX-TX supports bidirectional serial data via the twisted pair cable to/from the 232 port on a DX-RX. The DX-TX also has IR ports.

HDMI TX – The HDMI TX receives an HDMI signal and an audio signal from a source device. The audio can be either digital audio embedded with the HDMI, digital audio over S/PDIF, or analog stereo audio. Both the video and audio are transported over twisted pair cable to an Enova DGX Digital Media Switcher, an applicable Enova DVX Solution (to an DX-RX), or directly to a DX-RX. The 232 port (RS-232) on the HDMI TX supports bidirectional serial data via the twisted pair cable to/from the 232 port on a DX-RX. The HDMI TX also has IR ports.

Wallplate TX and Decor Wallplate TX – These wallplates receive an HDMI signal or analog video signal (composite, Y/C, Y/Pb/Pr, RGB, RGBS, or RGBHV) and an audio signal from a source device. The audio can be either digital audio embedded with the HDMI signal or analog stereo audio.

Either analog or digital video is transmitted out of the DXLink output. The active video selection is made using one of two methods: 1) Automatic, which selects digital video as the priority video input or analog video when no digital video is present. 2) Active ICSP command video input selection from a bound NetLinX Central Controller.

Both the video and audio are transported over twisted pair cable to an Enova DGX Digital Media Switcher, an applicable Enova DVX Solution, or directly to an DX-RX. Direct connection requires either PDXL-2 (FG1090-170) or PS-POE-AT-TC (FG423-84).

DX-RX – The DX-RX receives an HDMI signal with embedded audio over twisted pair cable from a DXLink compatible device (or from a DXLink Transmitter) and sends the signal on to the destination. Audio received on the DX-RX can also be output on the Stereo Audio Out port if it originated as a 2 channel audio signal. The 232 port (RS-232) on the DX-RX supports bidirectional serial data via the twisted pair cable to/from the 232 port on the DX-TX or HDMI TX. The DX-RX features SmartScale® Technology (integrated EDID output scaling) to ensure an appropriate output resolution, plus it supports a Manual (override) option for setting up custom resolutions and a Bypass option. The DX-RX also has IR ports.

NOTE: If a DVI-D signal is used (via a DVI-to-HDMI cable adapter), the advanced audio support from HDMI will not be available.

NOTE: These DXLink products support several different modes which are available for system setup and use. Brief explanations of the modes are provided in the section “Quick Reference Tables for Modes” on page 20 along with page references to complete information.

Product Compatibility Tables

The Transmitters and the Receiver are compatible with the DXLink products listed in the three tables following.

Enova DGX Solutions and DXLink Functions

The following table shows which Enova DVX products support specific DXLink functions.

DXLink Functions in Enova DGX Solutions		
	DXLink Twisted Pair Input Boards	DXLink Twisted Pair Output Boards
DXLink Inputs	Up to 8, 16, 32, 64*	–
Power on DXLink Inputs**	Yes	–
DXLink Outputs	–	Up to 8, 16, 32, 64*
Power on DXLink Outputs**	–	Yes

* Inputs and outputs up to 8, 16, 32, or 64 depending on the system (in increments of 4 inputs or outputs per board).

** For power budget information for system planning when using DXLink Transmitters and Receivers with an Enova DGX Digital Media Switcher, see page 31.

Enova DVX Solutions and DXLink Functions

The following table shows which Enova DVX products support specific DXLink functions.

DXLink Functions in Enova DVX Solutions***					
	DVX-3156HD	DVX-3155HD	DVX-3150HD	DVX-2155HD	DVX-2150HD
DXLink Inputs	4	2	0	2	0
Power on DXLink Inputs	Yes	Yes	NA	Yes	NA
DXLink Outputs	2	2	2	1	1
Power on DXLink Outputs	No	No	No	Yes	Yes

*** Does not apply to the DVX-2100HD.

Solecis Solutions and DXLink Functions

The following table shows which Solecis products support specific DXLink functions.

DXLink Functions in Solecis Solutions			
	SDX-510M-DX	SDX-410-DX	SDX-810-DX
DXLink Inputs	0	0	0
Power on DXLink Inputs	NA	NA	NA
DXLink Outputs	1	1	1
Power on DXLink Outputs	Yes	No	No

DXLink Transmitter and Receiver Features

NOTE: *The Wallplate TX and Decor Wallplate TX have a limited set of features (i.e., no S/PDIF, IR, or serial ports).*

- Incorporates HDMI® technology
- HDCP 1.3 compatible
- Supports computer video up to 1920x1200, HDTV up to 1080p, as well as 3D support (3D and Deep Color)
- Supports HDMI passthrough with embedded digital audio and single link DVI (DVI-to-HDMI cable adapter required)
- DX-TX, Wallplate TX, and Decor Wallplate TX support analog video: composite, Y/C, Y/Pb/Pr, RGB, RGBS, or RGBHV
- Reads the downstream EDID from the switcher (Endpoint Mode) or the sink (Extender Mode)
- Transports video signals over distances up to 328 feet (100 m) via the DXLink connection
- Interruption free content when used in conjunction with a switcher, AMX's exclusive InstaGate Pro® Technology allows audio and video to be switched quickly and easily to every connected display without the difficulties typically associated with HDCP.
- AutoDetect on the TXs and SmartScale® on the DX-RX work to automatically recognize any device's supported resolutions and signal type parameters, allowing switching out source and destination devices without manual setup. Also included is the ability to control detailed timing parameters for customized video output formats. (SmartScale is the ability to configure the scaling output by automatically selecting destination defined resolutions.)
- Supports HDMI embedded digital audio, digital audio over S/PDIF, and analog stereo audio
- Standard twisted pair cable saves time and installation effort
- The USB port on the DX-RX passes keyboard and mouse USB signals to control a remote computer. The Transmitter's USB port connects to a Host PC and will forward HID keyboard and mouse data received from a directed Receiver's USB port. (For USB port information, see page 18.)
- The 232 port (RS-232 serial) supports bidirectional transfer of serial data between Master and TX or RX (Endpoint Mode) or between TX and RX (Extender Mode)
- The IR port supports bidirectional transfer of IR data between Master and TX or RX (Endpoint Mode) or between TX and RX (Extender Mode)
- Power over DXLink (twisted pair cable) support when used with a switcher or with an approved AMX Power over DXLink device (for power budget information when used with an Enova DGX Digital Media Switcher, see page 31)
- A desktop power supply (ENERGY STAR® qualified) is provided per module. The Wallplate TX and Decor Wallplate TX receive power from the switcher or can be used with a DXLink power injector (for power budget information, see page 31).
- The modules are compatible with all V Style, versatile mounting options including rack, surface, and pole. The Wallplate TX includes a mounting bracket, and the Decor Wallplate TX mounts in a standard US double-gang box.
- Backed by AMX's 3 year warranty (see www.amx.com)
- 24-hour technical support

NOTE: *Features and specifications described in this document are subject to change without notice.*

Common Applications

DXLink Transmitters and Receivers are designed to send audio, video, and control to a remote display across the room, on the other side of the house, or to a classroom down the hall. The installation's requirements dictate the system setup which generally takes one of the following three forms.

- **Endpoint Mode (Switcher)** – One or more Transmitters and/or Receivers are connected to a switcher* containing an integrated Master (see page 28).
- **Endpoint Mode (Standalone)** – A standalone DXLink TX/RX pair** are connected directly to each other but, in addition, either the TX or RX is connected to a NetLinx Central Controller via a LAN or directly to the Controller (see page 30).
- **Extender Mode (Standalone)** – A standalone DXLink TX/RX pair** are connected directly to each other as a simple extender solution (see page 31).

* The switcher can be either an Enova DGX Switcher or an applicable Enova DVX Solution (see page 8).

** A wallplate in a standalone configuration requires power via a DXLink power injector.

Transmitters

NOTE: If a DVI-D signal is used (via a DVI-to-HDMI cable adapter), the advanced audio support from HDMI will not be available.

DXLink Multi-Format TX (DX-TX) Front View

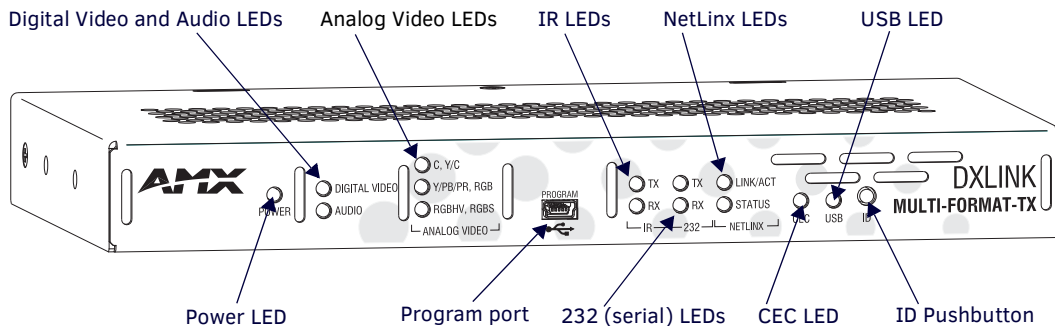

FIG. 1 DX-TX front view

DXLink HDMI TX (AVB-TX-HDMI-DXLINK) Front View (product discontinued)

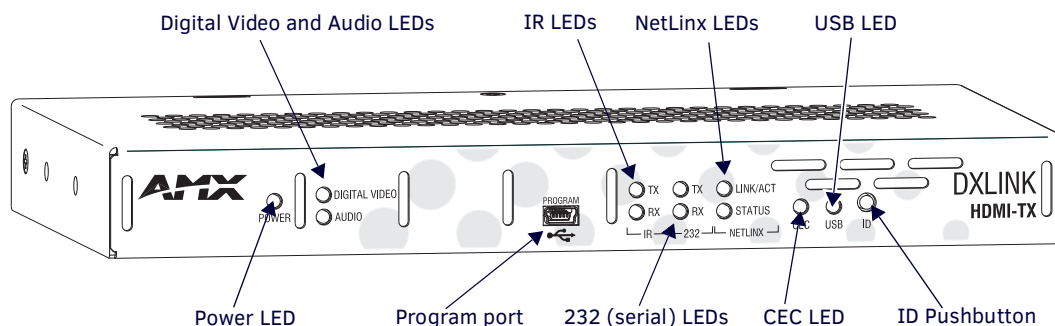

FIG. 2 HDMI TX front view

Components located on front of DX-TX and HDMI TX (left to right):

- **Power LED** – Indicates when the DX-TX or HDMI TX is powered on
- **Digital Video and Audio LEDs** – Indicate the presence of digital video and digital audio signals, including an embedded audio signal on the HDMI path
- **Analog Video LEDs (DX-TX only)** – Indicate the type of analog video present through the DX-TX: composite or Y/C; Y/Pb/Pr or RGB; RGBHV or RGBS
- **Program port** – This port (USB mini-B connector) supports DGX Configuration Software for programming a customer VGA EDID
- **IR LEDs** – TX and RX LEDs indicate active IR communication
- **232 LEDs (RS-232 serial)** – TX and RX LEDs indicate active serial communication
- **NetLinx LEDs** – Link/Act LED indicates network communication activity. The Status LED indicates unit status.
- **CEC LED** – CEC is not currently supported
- **USB LED** – When illuminated, the LED indicates that the USB port is connected and enabled
- **ID Pushbutton** – Places the DX-TX or HDMI TX in ID Mode for setting the NetLinx ID (device only) and provides additional functionality, such as placing the device in Static IP Mode or DHCP Mode

DX-TX and HDMI TX LEDs

DX-TX and HDMI TX Indicator LEDs		
LED	Normal Display	Indicates
Power	Green	Power is applied to the Transmitter Module
Digital Video	Green	A digital video signal is present through the Transmitter Module
Audio	Green	Embedded audio signal is present through the Transmitter Module
Analog Video (DX-TX only)	One of the 3 LEDs will be Green	The type of analog video present through the DX-TX: <ul style="list-style-type: none"> • C (composite) or Y/C (two component) • Y/PB/PR or RGB (three component) • RGBHV (five component) or RGBS (four component)
IR TX	Red	IR TX active communication
IR RX	Yellow	IR RX active communication
232 (Serial) TX	Red	Serial TX active communication
232 (Serial) RX	Yellow	Serial RX active communication
NetLinx Link/Act	Green	Active LAN connection to an AMX Network (Blinking = #3 Toggle OFF)
NetLinx Status	Green	LAN connection is active

NOTE: For detailed behavior of the NetLinx Link/Act and Status LEDs on the module's front, see page 50. For detailed behavior of the RJ-45 connector LEDs on the module's rear, see page 40.

DXLink Multi-Format Wallplate TX (DX-TX-WP) Front View

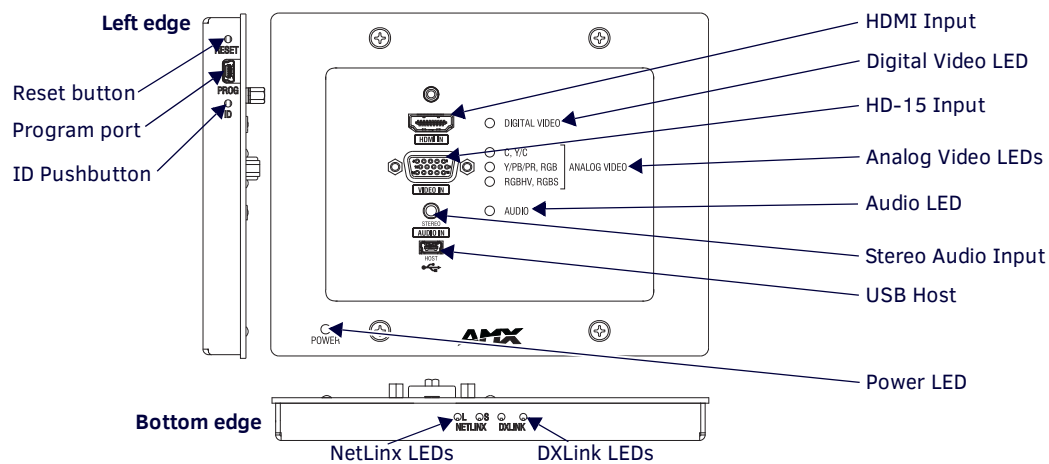

FIG. 3 Multi-Format Wallplate TX front view, plus left edge and bottom edge views

Components located on front of Wallplate TX:

- **HDMI In** – HDMI connector (with locking center screw) for digital video and embedded digital audio (supports a DVI-D signal with use of DVI-to-HDMI cable adapter). When more than one audio signal is present, HDMI embedded audio takes precedence over analog audio.
- **Digital Video LED** – Indicates the unit is configured to pass HDMI with embedded audio (default)
- **Video In** – An HD-15 connector for analog video: C (composite), Y/C, Y/Pb/Pr, RGB, RGBHV, or RGBS. Pinouts for analog video are on page 105
- **Analog Video LEDs** – Illuminates when the Wallplate TX is configured to pass analog video: composite or Y/C; Y/Pb/Pr or RGB; RGBHV or RGBS
- **Audio In Stereo** – Audio connector is a 3.5 mm stereo jack. An analog audio signal is only available when HDMI embedded digital audio is not present (or configured for analog audio).
- **Audio LED** – Indicates the unit is configured to pass analog audio (coupled with digital or analog video path)
- **USB Host port** – Mini-B USB connector (supports USB host) for receiving keyboard / mouse commands from a specific RX. (For USB port information, see page 18.)
- **Power LED** – Indicates when the Wallplate TX is powered on

Components located on left and bottom edges of Wallplate TX:

- **Reset button** (left) – Resets the Wallplate TX's CPU (acts like a power cycle soft reboot)
- **Program port** (left) – This port (USB mini-B connector) supports DGX Configuration Software for programming a customer VGA EDID
- **ID Pushbutton** (left) – Places the Wallplate TX in ID Mode for setting the NetLinX ID (device only) and provides additional functionality, such as placing the device in Static IP Mode or DHCP Mode
- **NetLinX LEDs** (bottom) – Left green LED (L = Link/Act) indicates network communication activity; right green LED (S = Status) indicates unit status
- **DXLink LEDs** (bottom) – Left yellow LED indicates HDCP status; right green LED indicates that a valid DXLink connection has been established

DXLink Decor Wallplate TX (DX-TX-DWP) Front View

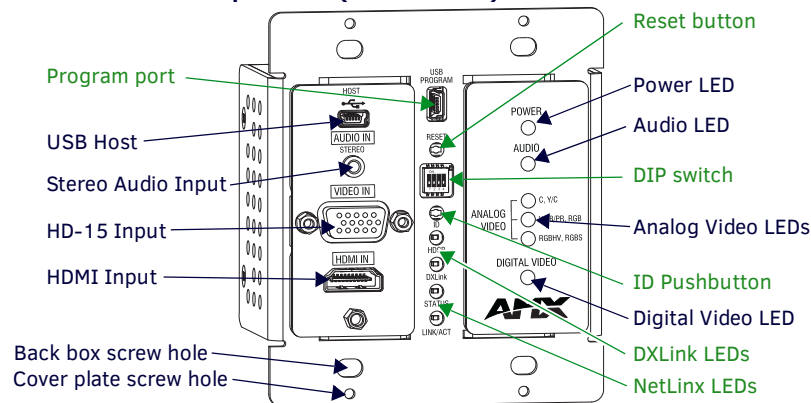

FIG. 4 Decor Wallplate TX front view (before customer provided standard decor style front cover plate is attached)

IMPORTANT: Be sure to measure the back box and any other components used to mount the Decor Wallplate TX prior to installation/construction to ensure the unit fits (e.g., some mud rings do not work unless their corners are modified).

Components located on left and right front sections of Decor Wallplate TX:

- **USB Host port** – Mini-AB USB connector (supports USB host) for receiving keyboard / mouse commands from a specific RX. (For USB port information, see page 18.)
- **Audio In Stereo** – Audio connector is a 3.5 mm stereo jack. An analog audio signal is only available when HDMI embedded digital audio is not present (or configured for analog audio).
- **Video In** – An HD-15 connector for analog video: C (composite), Y/C, Y/Pb/Pr, RGB, RGBHV, or RGBS. Pinouts for analog video are on page 105
- **HDMI In** – HDMI connector (with locking center screw) for digital video and embedded digital audio (supports a DVI-D signal with use of DVI-to-HDMI cable adapter). When more than one audio signal is present, HDMI embedded audio takes precedence over analog audio.
- **Power LED** – Indicates when the Decor Wallplate TX is powered on
- **Audio LED** – Indicates the unit is configured to pass analog audio (coupled with digital or analog video path)
- **Analog Video LEDs** – Illuminates when the Decor Wallplate TX is configured to pass analog video: composite or Y/C; Y/Pb/Pr or RGB; RGBHV or RGBS
- **Digital Video LED** – Illuminates when the Decor Wallplate TX is configured to pass HDMI with embedded audio (default)

The Decor Wallplate TX has a number of front panel components, some can be seen when a standard decor style front cover plate is attached and some are hidden by the plate (FIG. 4 shows all of them). The cover plate is customer provided to allow matching the individual decor of an environment or matching other standard decor covers in a room/area.

Components located on center front section of Decor Wallplate TX:

- **USB Program port** – This port (USB mini-B connector) supports DGX Configuration Software for programming a customer VGA EDID
- **Reset button** – Resets Decor Wallplate TX's CPU (acts like power cycle soft reboot)
- **Dip switch** – A four-toggle DIP switch is used for enabling/disabling special functionality (see page 34)
- **ID Pushbutton** – Places the Decor Wallplate TX in ID Mode for setting the NetLinX ID (device only) and provides additional functionality, such as placing the device in Static IP Mode or DHCP Mode
- **DXLink LEDs** – HDCP LED indicates HDCP status; DXLink LED indicates that a valid DXLink connection has been established
- **NetLinX LEDs** – Status LED indicates unit status; Link/Act LED indicates network communication activity

Wallplate TX and Decor Wallplate TX Front LEDs

Wallplate TX and Decor Wallplate TX Indicator LEDs		
LEDs	Normal Display	Indicates
Digital Video (default)	Green	The Wallplate TX and Decor Wallplate TX have been configured* to pass HDMI (for SEND_COMMAND information, see page 68)
Analog Video	One of the 3 LEDs will be Green	The Wallplate TX and Decor Wallplate TX have been configured* to pass one of the following types of analog video (for SEND_COMMAND information, see page 68): <ul style="list-style-type: none"> • C (composite) or Y/C (two component) • Y/PB/PR or RGB (three component) • RGBHV (five component) or RGBS (four component)
Audio	Green	The Wallplate TX and Decor Wallplate TX have been configured* to pass analog audio as the audio source being embedded on the DXLink output connection (coupled with either the analog or digital video input path); for SEND_COMMAND information, see page 72
Power	Green	Power (from switcher) is applied to the unit
LEDs (bottom edge of Wallplate TX)		
NetLinx - L (Link)	Green	Active LAN connection to an AMX Network (Blinking = #3 Toggle OFF)
NetLinx - S (Status)	Green Off	<ul style="list-style-type: none"> • Speed status is 100 Mbps • Speed status is 10 Mbps
DXLink Yellow	Yellow Flashing Off	<ul style="list-style-type: none"> • Authenticated HDCP (handshaking has occurred successfully) • Video is active; no HDCP • No Video
DXLink Green	Green	DXLink connection is established
LEDs (under customer provided front cover plate on Decor Wallplate TX)		
HDCP (DXLink)	Yellow Flashing Off	<ul style="list-style-type: none"> • Authenticated HDCP (handshaking has occurred successfully) • Video is active; no HDCP • No Video
DXLink	Green	DXLink connection is established
Status (NetLinx)	Green Off	<ul style="list-style-type: none"> • Speed status is 100 Mbps • Speed status is 10 Mbps
Link/Act (NetLinx)	Green	Active LAN connection to an AMX Network (Blinking = #3 Toggle OFF)

* The LEDs for Digital Video, Analog Video, and Audio each indicate the configured state of the connectors, not necessarily the presence of signals through the Wallplate TX and Decor Wallplate TX.

NOTE: Detailed behavior for the NetLinx-L and NetLinx-S LEDs on the Wallplate TX or Link/Act and Status LEDs on the Decor Wallplate TX are on page 50, and basic information for the LEDs on the RJ-45 connector on the rear of the Wallplate TX and Decor Wallplate TX is on page 40.

TIP: If the Wallplate TX is installed in a location where it is difficult to check the LEDs on the bottom edge, slide a white piece of paper or a small mirror under the edge to view LED status.

DX-TX Rear View

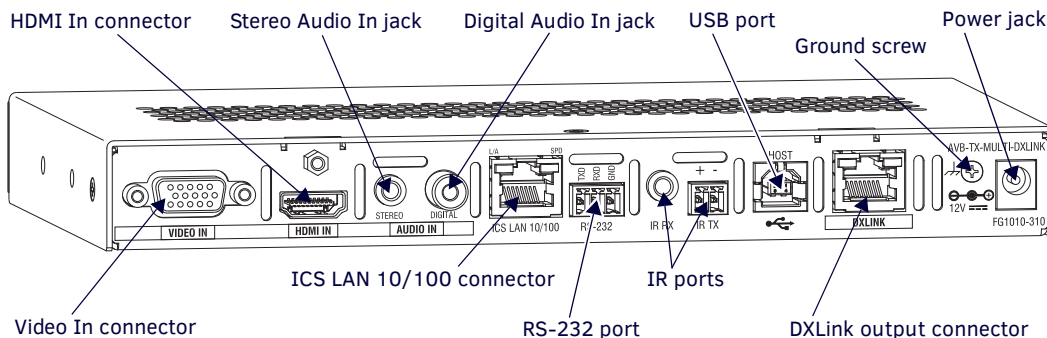

FIG. 5 DX-TX rear view

HDMI TX Rear View (product discontinued)

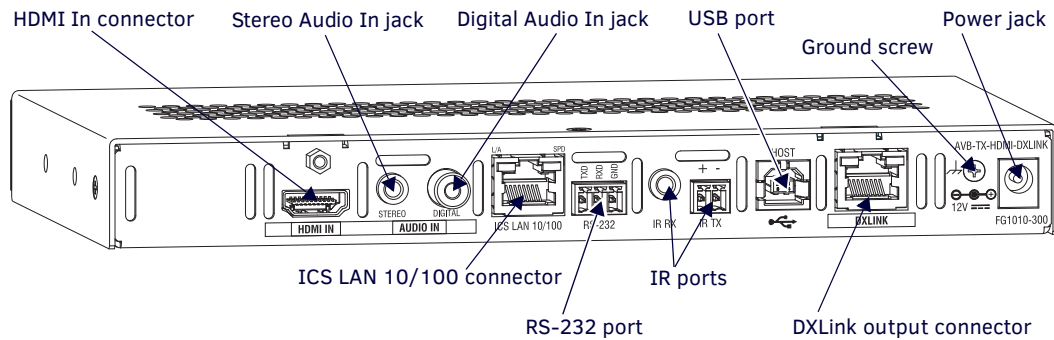

FIG. 6 HDMI TX rear view

NOTE: The DX-TX and HDMI TX each have a DIP switch on the bottom (see page 17).

The following components are located on the rear of DX-TX and HDMI TX Modules (from left to right):

- **Video In Connector (DX-TX only)** – The Video In connector on the DX-TX is an HD-15 connector for analog video (composite, Y/C, Y/Pb/Pr, RGB, RGBHV, or RGBS). Pinouts for analog video are on page 105.

NOTE: When an analog video source cable is plugged into the DX-TX, the Video LEDs on the front and on the Receiver turn green to show that video is present through the system. In addition, one of the Analog Video LEDs on the front of the DX-TX and the DX-RX turns green to show the type of video that is present through the system.

- **HDMI In Connector** – The HDMI In connector is for digital video and embedded digital audio. When more than one audio signal is present and the default “auto” mode is enabled, HDMI embedded audio takes precedence over S/PDIF and analog audio.

When a NetLinX Central Controller is connected, an audio format SEND_COMMAND is available (the Transmitter *must* be set for network connectivity via #3 Toggle) to select the desired audio source (see page 72).

The HDMI connector has a center screw for locking capability. The HDMI connector also supports a DVI-D signal with the use of a DVI-to-HDMI cable adapter.

NOTE: When a digital video source cable is plugged into the HDMI connector, the Video LEDs on the front of the DX-TX or HDMI TX and Receiver turn green to show that video is present through the system.

- **Stereo Audio In Jack** – The Stereo Audio In jack is a 3.5 mm stereo jack. By default, the stereo audio jack will be third in priority behind the embedded audio on the HDMI input and digital audio on the RCA connector.
When a NetLinX Central Controller is connected, an audio format SEND_COMMAND is available (the Transmitter *must* be set for network connectivity via #3 Toggle) to select the desired audio source (see page 72).
- **Digital Audio In Jack**– The Digital Audio In jack is an RCA jack for an S/PDIF audio signal. When more than one audio signal is present and the default “auto” mode is enabled, HDMI embedded audio takes precedence over S/PDIF, which takes precedence over analog audio.
When a NetLinX Central Controller is connected, an audio format SEND_COMMAND is available (the Transmitter *must* be set for network connectivity via #3 Toggle) to select the desired audio source (see page 72).
- **ICS LAN 10/100 Connector** – The ICS LAN 10/100 (RJ-45) connector provides for Ethernet 10/100 connectivity (e.g., receiving SEND_COMMANDs and downloading firmware update files). For pinout and LED information, see page 39.
- **RS-232 (Serial) Port** – The RS-232 port (serial data interface) is a 3-position screw terminal block which accepts data from the source device and transfers it via the twisted pair cable to the DX-RX, which in turn transfers the data to the destination device. The transfer of data can also be made from the destination to the source. In addition to being directly connected to a device, this port can be connected as an independent native NetLinX control port from a networked NetLinX Central Controller.
- **IR RX Port** – The IR RX port is used for IR control (see page 19). This port is a 3.5 mm stereo jack. In addition to being directly connected to a device, this port can be connected as an independent native NetLinX control port from a networked NetLinX Central Controller.
- **IR TX Port**– The IR TX port is used for IR control (see page 19). This port is a 2-way mini-Phoenix connector. In addition to being directly connected to a device, this port can be connected as an independent native NetLinX control port from a networked NetLinX Central Controller.
- **USB Port** – The USB-B port on the rear of the DX-TX and HDMI TX is connected to a PC and supports a USB device. This is the Host port that is used in conjunction with the USB-A port on the rear of the DX-RX for sending keyboard / mouse commands to a connected PC at the Transmitter. (For USB port information, see page 18.)
- **DXLink Output Connector** – The DXLink (RJ-45) connectors transport digital video, embedded audio, Ethernet, and bidirectional control over twisted pair cable to DXLink devices or boards (or an DX-RX), including digitally transcoded analog video signals. The DXLink path supports HDCP. The DXLink line also supports power from an Enova DGX Switcher and from some Enova DVX Solutions to power the module. For pinout and LED information, see page 39.
- **Ground Screw** – The ground screw is used for creating a technical ground for the ungrounded sources/destinations with respect to the DXLink Transmitters/Receivers and switcher (see page 37).

- **Power Jack** – The power receptacle is a 2.1 mm DC jack for connecting power. Power can come from a locally connected DC supply of 12 V. The automatically adjusting universal 110/220 IEC power supply is provided. The power supply is ENERGY STAR[®] qualified to ensure maximum efficiency and savings.

IMPORTANT: If desktop power is used to power the Transmitter, only the provided desktop power supply should be used and it must not be altered in any way. Remote power can also be provided via a switcher, PDXL-2 (FG1090-170), or PS-POE-AT-TC (FG423-84).

NOTE: Transmitter Modules can also be powered via the DXLink connector when attached to a DXLink Input Board in an Enova DGX Switcher. We recommend calculating the power budget for the switcher to maintain the redundancy of its power supplies (see page 31).

Wallplate TX and Decor Wallplate TX Rear View

Located on the rear of the Wallplate TX are a DXLink (RJ-45) connector and a DIP switch.

The Decor Wallplate TX also has its DXLink connector on the rear, but its DIP switch is on the front (see page 17). The front can be covered with a customer provided standard decor style front cover plate.

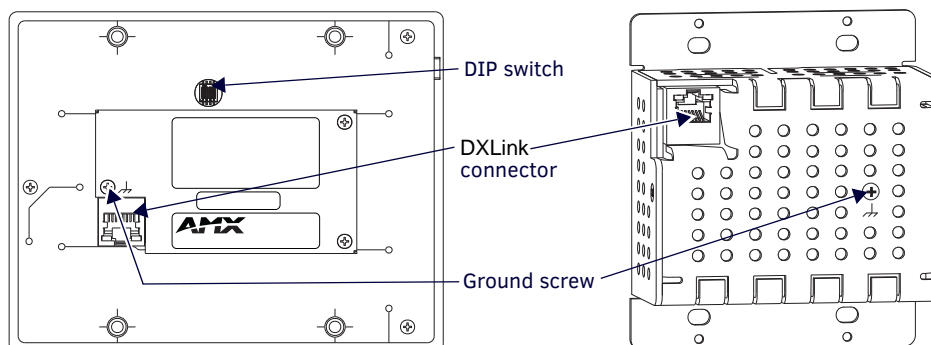

FIG. 7 Wallplate TX rear view (mounting bracket removed) and Decor Wallplate TX rear view

- **DXLink Output Connector** – The DXLink (RJ-45) connectors transport digital video, embedded audio, bidirectional control, and Ethernet (SEND_COMMANDS only) over twisted pair cable to DXLink devices or boards, including digitally transcoded analog video signals. The DXLink path supports HDCP. In addition, the Wallplate TX and Decor Wallplate TX receive power over the DXLink line from an Enova DGX Switcher, some Enova DVX Solutions, or PDXL-2 (FG1090-170) or PS-POE-AT-TC (FG423-84). For pinout and LED information, see page 40.
- **DIP Switch** – The DIP switch is on the rear of the Wallplate TX. It is on the front of the Decor Wallplate TX and can be covered with a customer provided standard decor style front cover plate. For information on the DIP switch, see page 17.
- **Ground Screw** – The ground screw is used for creating a technical ground for the ungrounded sources/destinations with respect to the DXLink Transmitters/Receivers and switcher (see page 37).

Receiver

NOTE: If a DVI-D signal is used (via a DVI-to-HDMI cable adapter), the advanced audio support from HDMI will not be available.

DXLink HDMI Receiver (DX-RX) Front View

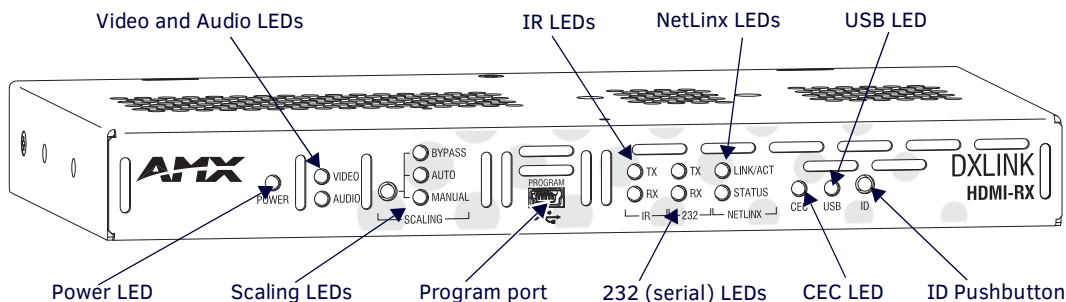

FIG. 8 DX-RX front view

NOTE: The DX-RX has a DIP switch on the bottom; for details, see page 17.

The following components are located on the front of the DX-RX (left to right):

- **Power LED** — Indicates when the DX-RX is powered on.
- **Video and Audio LEDs** — Indicate the presence of video and embedded audio signals through the DX-RX.
- **Scaling button and LEDs** — Use the Scaling button to select one of the 3 scaling options: Bypass, Auto (default), or Manual. For information on using the Scaling button and options for persisting the Scaling Mode, see page 49.
- **Program port** — This port is a USB mini-B connector.
- **IR LEDs** — TX and RX LEDs indicate active IR communication.
- **232 (RS-232) LEDs** — TX and RX LEDs indicate active serial communication.
- **NetLinx LEDs** — Link/Act LED indicates network communication activity. The Status LED indicates unit status.
- **CEC LED** — CEC is not currently supported.
- **USB LED** — When illuminated, the LED indicates that the USB port connection has been established (for details, see page 19).
- **ID Pushbutton** — Places the DX-RX in ID Mode for setting the NetLinx ID (device only) and provides additional functionality, such as placing the device in Static IP Mode or DHCP Mode.

Receiver Module LEDs

HDMI RX Indicator LEDs		
LED	Normal Display	Indicates
Power	Green	Power is applied to the Receiver
Video	Green	A video signal is present through the Receiver
Audio	Green	An embedded audio signal is present through the Receiver
Scaling: – Bypass – Auto – Manual	One LED is green The other two are off	The Receiver is in one of the three modes for scaling <ul style="list-style-type: none"> • At initial power up, the Receiver defaults to the Auto scaling option* • Pressing the Scaling button cycles the module through the options: Bypass, Auto, and Manual • If Bypass is solid and Auto is flashing, then the RX is trying to read EDID from the sink
IR TX	Red	IR TX active communication
IR RX	Yellow	IR RX active communication
Serial TX	Red	Serial TX active communication
Serial RX	Yellow	Serial RX active communication
NetLinx Link/Act	Green	Active LAN connection to an AMX Network (Blinking = #3 Toggle OFF)

* When the output cable is disconnected from the DX-RX or if no EDID can be found on the destination device, the last used Scaling Mode LED will be ON. In either case, the DX-RX will continue to hold its output resolution to the last known preferred resolution until a power cycle or reconnection of a sink with a valid EDID. On power up without a valid EDID, the default preferred output resolution presented will be 1280x1024,60Hz until a different EDID is detected.

NOTE: For detailed behavior of the NetLinx Link/Act and Status LEDs on the module's front, see page 50. For detailed behavior of the RJ-45 connectors' LEDs on the module's rear, see page 40.

Receiver Rear View

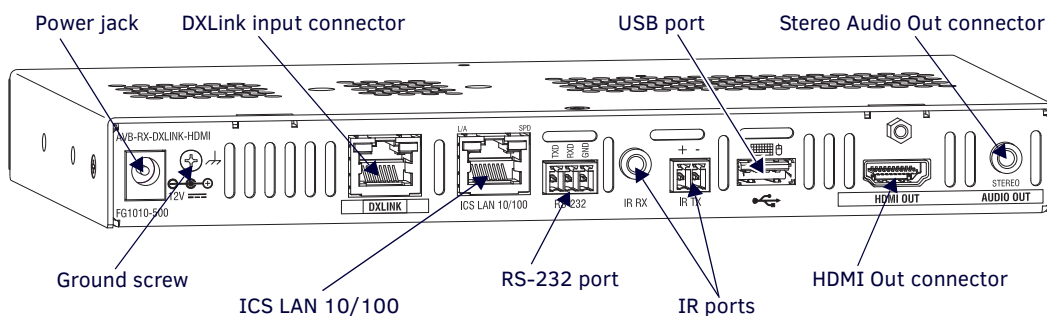

FIG. 9 DX-RX rear view

The following components are located on the rear of the DX-RX (left to right):

- **Power Jack** – The power receptacle is a 2.1 mm DC jack for connecting power. Power can come from a locally connected DC supply of 12 V. An automatically adjusting universal 110/220 IEC power supply is provided. The power supply is ENERGY STAR® qualified to ensure maximum efficiency and savings.

IMPORTANT: If desktop power is used to power the Receiver, only the provided desktop power supply should be used and it must not be altered in any way. Remote power can also be provided via a switcher, PDXL-2 (FG1090-170), or PS-POE-AT-TC (FG423-84).

NOTE: The DX-RX can also be powered through the DXLink connector when it is attached to a DXLink Output Board in an Enova DGX Switcher. We recommend calculating the power budget for the switcher to maintain the redundancy of its power supplies (see page 31).

- **Ground Screw** – The ground screw is for creating a technical ground for the ungrounded sources/destinations with respect to the DXLink Transmitters/Receivers and switcher (see page 37).
- **DXLink Input Connector** – The DXLink (RJ-45) connectors transport digital video, embedded audio, Ethernet, and bidirectional control over twisted pair cable to DXLink devices or boards, including digitally transcoded analog video signals. The DXLink path supports HDCP and also supports power over the same path from an Enova DGX Switcher and from some Enova DVX Solutions to power the module. For pinout and LED information, see page 39.
- **ICS LAN 10/100 Connector** – The ICS LAN 10/100 (RJ-45) connector is for Ethernet 10/100 connectivity (e.g., receiving SEND_COMMAND commands and downloading firmware update files). For pinout and LED information, see page 39.
- **RS-232 Port** – The RS-232 (serial data interface) port is a 3-position screw block which accepts data from the source device and transfers it via the twisted pair cable to the DX-RX, which in turn transfers the data to the destination device or the transfer of data can also be made from the destination to the source. In addition to being directly connected to a device, this port can be connected as an independent native NetLinx control port from a networked NetLinx Central Controller.
- **IR RX Port** – The IR RX port is used for IR control (see page 19). This port is a 3.5 mm stereo jack. In addition to being directly connected to a device, this port can be connected as an independent native NetLinx control port from a networked NetLinx Central Controller.
- **IR TX Port** – The IR TX port is used for IR control (see page 19). This port is a 2-way mini-Phoenix connector. In addition to being directly connected to a device, this port can be connected as an independent native NetLinx control port from a networked NetLinx Central Controller.
- **USB Port** – The USB-A port on the RX supports keyboard/mouse. This port is used in conjunction with the USB-B Host port on the HDMI TX which supports a USB device and connects to the PC. (For USB port information, see page 18.)
- **HDMI Out Connector** – The HDMI Out connector is for digital video and embedded audio. The HDMI connector has a center screw for locking capability. The HDMI connector also supports a DVI-D signal (a DVI-to-HDMI cable adapter is required).
- **Stereo Audio Out Connector** – The Stereo Audio Out connector is a 3.5 mm stereo jack. This connector has an analog audio signal available for output whether the embedded audio over the DXLink cable originated as 2 channel digital or analog stereo. If encoded digital audio (e.g., Dolby or DTS) or multi-channel audio paths (>2 CH L-PCM) are embedded on the HDMI path, then this local analog port out will not be available.

Common Features/Functionality

This section covers the DIP switches, the USB port, HDCP compliance, and IR functionality.

DIP Switches

TIP: For easiest access to the DIP switch toggles, we recommend setting them before installation.

A four-toggle DIP switch is on the bottom of the DXLink Modules, on the rear of the Wallplate TX, and on the front of the Decor Wallplate TX (the front can be covered with a customer provided standard decor style front cover plate).

- #1 Toggle is used for enabling/disabling the physical ICS LAN 10/100 port (see page 34).
- #2 Toggle is used for setting the DXLink Modules to either automatically or manually determine the DXLink Mode (see page 35).
- #3 Toggle is used for enabling/disabling network connectivity of the DXLink Transmitter or Receiver to a connected NetLinx Central Controller (used for IR ports, serial ports, and commands to the DXLink unit); see page 35.
- #4 Toggle is not functional.

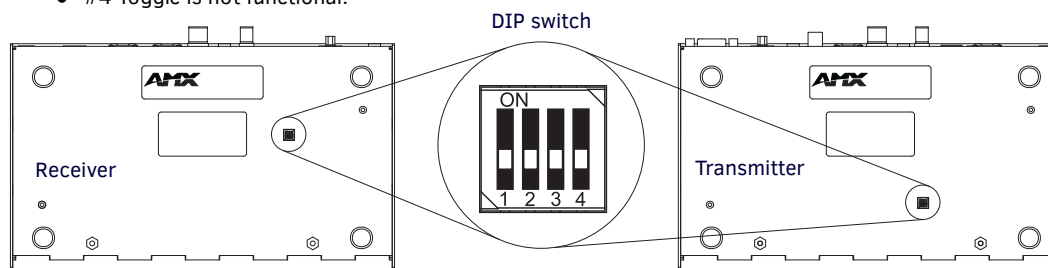

FIG. 10 DIP switch location on DXLink Modules

NOTE: The mounting bracket on the Wallplate TX must be removed (unscrew the four screws from the bracket and set it aside) before the DIP switch toggles can be set.

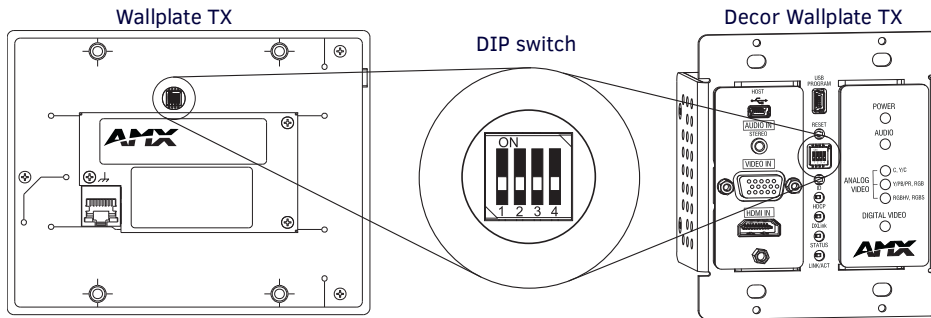

FIG. 11 DIP switch on Wallplate TX (remove mounting bracket) and on Decor Wallplate TX

For complete information on setting DIP switches (including settings for common scenarios), see the section starting on page 34.

USB Port (Rear)

DX-TX

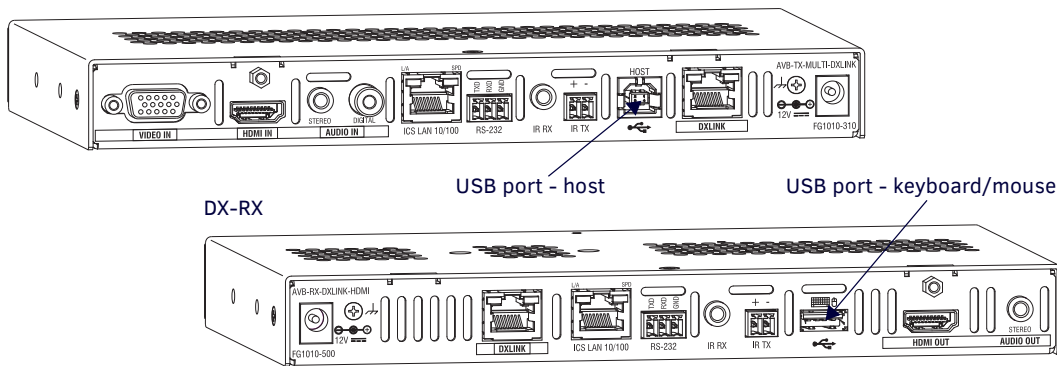

FIG. 12 TX USB port = host (top); RX USB port = keyboard/mouse (bottom)

DX-TX and HDMI TX

The USB-B port on the rear of the DX-TX and HDMI TX can be connected to a PC to support a USB device. This port is considered the Host port, which is used in conjunction with the USB-A port on the rear of the DX-RX. As the Host port, it is connected to a PC and passes through information via the DXLink connection to the DX-RX. A USB (mini-B) Host port is also available on the Wallplate TX and a USB (mini-AB) Host port is available on the Decor Wallplate TX.

DX-RX

The USB-A port on the rear of the DX-RX supports passthrough information from the USB Host port on the Transmitter to an HID (Human Interface Device), which is most commonly a keyboard or mouse.

HID Devices and Windows 8

Windows 8 will not wake up from a DXLink connected keyboard or mouse unless the properties for the HID device are set to allow the device to wake the computer. (Note that even a hot plug of the USB cable will not restore connectivity.)

To set Windows 8 to work with DXLink modules and HID devices:

1. On the PC, go to Start > Control Panel > Device Manager and expand “Keyboards.”
2. Right-click the HID Keyboard Device and select Properties.
The HID Keyboard Device Properties dialog box opens.

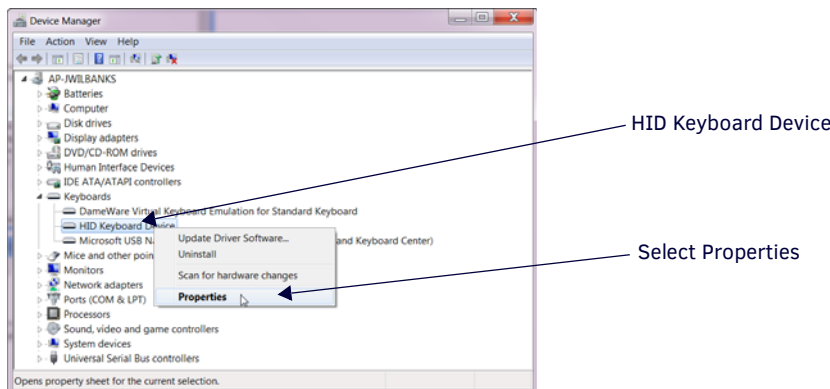

3. Select the Power Management tab and click “Allow this device to wake the computer.”

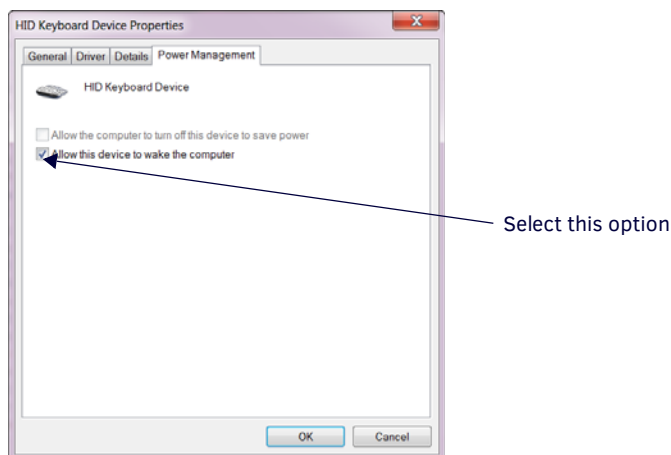

4. Click OK.
5. Repeat steps for HID mouse (in the Device Manager dialog box, expand “Mice”).

HID Devices

A list is available of HID devices which have been tested and found to be working well with the latest firmware (see “DXLink - HID supported Devices” on the DXLink Receiver’s product page at www.amx.com).

USB LED

The USB LED on the front of a Transmitter or Receiver Module monitors the USB port on the rear of the unit. The USB LED illuminates (yellow) when a USB device is detected (the port default is “enabled”).

To disable the port on the Transmitter, either disconnect the cable or send the following SEND_COMMAND: USB_HID_SERVICE-DISABLE. The enable/disable command persists through power cycling. To enable the port, send: USB_HID_SERVICE-ENABLE. The USB ports support a limited number of SEND_COMMANDs, see page 77.

HDCP Compliance

If the connected downstream sink is not HDCP compliant, then the HDMI output on the Receiver will not send the signal. This does not affect additional displays the source may be routed to, i.e., HDCP compliant displays will still show content from the source device even when the source device is also routed to non-compliant displays. Non-compliant devices can be easily identified because they display a dark red image or an orange image to indicate the authentication process failed.

IR Control on DX-TX, HDMI TX, and DX-RX (Optional)

The following two items are required for IR control. In addition, a compatible remote control unit can be used with the system. (The two items listed are not included with the modules.)

- **IRO3** – External IR Receiver Module (FG-IRO3). The IRO3 can be connected to the IR RX port on the DX-TX or HDMI TX or to the IR RX port on the DX-RX, allowing IR signals to be received from a compatible IR remote control. The IRO3 allows the DX-TX or HDMI TX to be placed behind the display device if desired.
- **CC-NIRC** – NetLinx IR Emitter Cable (FG10-000-11). The CC-NIRC can be connected to the IR TX port on the Transmitter or to the IR TX port on the DX-RX. This allows IR signals to be sent to the source device from the DX-TX or HDMI TX or to the display device from the Receiver.

Quick Reference Tables for Modes

The modes listed in the following three tables are those supported by DXLink Transmitters and Receivers. The Quick Reference Tables are intended to help users navigate the many modes available for system setup and use. For complete information on any of the modes listed, see the relevant sections or chapter referenced at the end of the Descriptions.

Quick Reference Table – Modes for Handling System Architecture	
Mode	Description
DXLink Modes	<p>DXLink Modes refer to the type of physical components and how they are connected to make up the system. When Transmitters and Receivers are cabled into a system and powered on, they automatically detect the DXLink Mode they are being used in.</p> <p>Endpoint Mode:</p> <ul style="list-style-type: none"> When the system is setup to use Transmitters and/or Receivers with an Enova DGX Digital Media Switcher or an applicable Enova DVX Solution, the system is in Endpoint Mode (see example on page 28). <p>Or</p> <ul style="list-style-type: none"> When a TX is directly connected to an RX but, in addition, the TX and/or RX is connected to a NetLinx Central Controller via a LAN or directly connected to the Controller, the system is in Endpoint Mode (see example on page 30). <p>Extender Mode:</p> <ul style="list-style-type: none"> When a TX is directly connected to an RX, the system is in Extender Mode (see example on page 31). <p>For further information, reference #2 Toggle DIP switch settings for DXLink Mode (see page 35) and DXLink System SEND_COMMANDS (see page 79).</p>

Quick Reference Table – Modes for Handling Addressing/Networking	
Mode	Description
IP Addressing Modes	<p>IP Addressing Modes refer to network connection settings. By default, all network connection settings are turned OFF.</p> <p>Static IP Mode:</p> <ul style="list-style-type: none"> This mode configures the network connection to one stable IP address the device will use continuously. <p>DHCP Mode:</p> <ul style="list-style-type: none"> This mode configures the network connection to choose a new IP address for each network session. <p>To enable network capability, see “Network Configuration” on page 52.</p>
ID Mode	<p>ID (Identify) Mode refers to the protocol for enabling a user to establish device addresses. This Mode, accessible through NetLinx Studio, places the entire system on hold while it waits for an event from a NetLinx device in the named system (e.g., pressing the ID Pushbutton on the TX or RX). For further information, see “Assign a Device Address (ID Mode)” on page 57.</p>
Ethernet Modes	<p>Ethernet Modes refer to the LAN configuration settings.</p> <p>Auto Mode:</p> <ul style="list-style-type: none"> This mode configures the LAN driver to discover its own settings based on the network it is connected to. <p>Speed/Duplex Mode:</p> <ul style="list-style-type: none"> This mode configures the LAN driver to calculate its speed as either 10 or 100 and to communicate in either half- or full-duplex. <p>Ethernet Mode discovery and configuration information is available through Telnet commands. For further information, see “Establishing a Terminal Connection Via Telnet” on page 91.</p>
Master Connection Modes	<p>Master Connection Modes refer to the modes of communication used for connection to the Master as specified via the SET CONNECTION Telnet command.</p> <p>Auto Mode:</p> <p>This mode utilizes TCP communication. It looks for a matching System Number and attempts to come online with the first Master it sees with that System Number.</p> <p>TCP URL Mode:</p> <p>TCP; the Master is specified via URL.</p> <p>UDP URL Mode:</p> <p>UDP; the Master is specified via URL.</p> <p>NDP Mode (Default):</p> <p>UDP; utilizes the NDP binding process to assign the DXLink Module (the physical device) to a Master (or Virtual Master) via NetLinx Studio. Once bound, communications are conducted via UDP.</p> <p>For further information, see “Master Connection Modes” on page 98.</p>

Quick Reference Table – Modes for Handling Addressing/Networking (continued)

Auto-setup Mode	<p>In auto-setup mode, endpoints are automatically discovered by and connected to an Enova DGX 100 Series Switcher using a single IP address. For this mode, <i>all of the following requirements must be met</i>. If not, the endpoint will no longer reside in auto-setup mode and must be either bound to the integrated Master (see page 52) or reconfigured to meet the requirements.</p> <ul style="list-style-type: none"> • Endpoint <i>must</i> be connected to a DXLink Input Board in an Enova DGX 100 Series Switcher (or Enova DGX 8/16/32/64 with upgraded 100 Series CPU) • Endpoint <i>must</i> have IP mode set to DHCP for setup (self-configures to Static IP on private LAN) • Endpoint <i>must</i> have the master connection type set to NDP • Endpoint <i>must</i> not be bound to a Master via NDP (traditional binding process) <p>IMPORTANT: <i>If auto-setup is being used, Telnet is the only way to access some of the network settings. Also note that some network settings will disable auto-setup.</i></p> <p>For additional information on the auto-setup feature, see the <i>Hardware Reference Manual – Enova DGX 100 Series Digital Media Switchers</i>.</p>
IR SEND_COMMAND Modes	<p>IR SEND_COMMAND Modes refer to displaying and setting the IR port active system settings as IR, Serial, or Data modes.</p> <p>GET MODE SEND_COMMAND:</p> <ul style="list-style-type: none"> • The GET MODE SEND_COMMAND reveals the active system (IR, Serial, or Data) settings. <p>SET MODE SEND_COMMAND:</p> <ul style="list-style-type: none"> • The SET MODE SEND_COMMAND changes the active system settings. <p>For further information, see “IR SEND_COMMANDS” on page 73.</p>

Quick Reference Table – Modes for Handling Video Processing

Mode	Description
Scaling Modes	<p>Scaling Modes refer to how the system alters or maintains a source device's resolution as it is passed along to the destination device. The Scaling Mode can be set on the DX-RX with the Scaling button (see page 49), or with SEND_COMMANDS (see page 66), or through DGX Configuration Software when scaling is being done via an Enova DXLink Output Board.</p> <p>Auto Mode (Default):</p> <ul style="list-style-type: none"> • Auto Mode (SmartScale®) allows the destination device to choose the resolution it needs. <p>Manual Mode:</p> <ul style="list-style-type: none"> • Manual Mode allows the user to configure the resolution the video will display through a destination device. <p>Bypass Mode:</p> <ul style="list-style-type: none"> • Bypass Mode allows the video signal to display over the destination device without altering the signal's resolution.

DXLink Transmitters and Receiver Specifications

The specifications in the table below apply to the following Transmitters and Receiver:

- FG1010-310 – DX-TX
- FG1010-300 – DXLink HDMI TX Module (discontinued)
- FG1010-320-BL – DX-TX-WP, Black*
- FG1010-320-WH – DX-TX-WP, White*
- FG1010-325-BL – DX-TX-DWP (US), Black*
- FG1010-325-WH – DX-TX-DWP (US), White*
- FG1010-500 – DX-RX

* A limited set of specifications apply, as the Wallplate TX and Decor Wallplate TX have a limited set of features when compared to the DX-TX and HDMI TX.

General Specifications

Parameter	Value
Approvals	CE, UL, cUL, FCC Class A, RoHS, WEEE
AC Power (Modules Only)	<ul style="list-style-type: none"> • 100 to 240 VAC single phase, 50 Hz to 60 HZ • 0.6 A @ 115 VAC max.

General Specifications (continued)	
Parameter	Value
DXLink Power	<ul style="list-style-type: none"> • DXLink Twisted Pair Transmitters (DX-TX, DX-TX-DWP, and DX-TX-WP): Power can also be supplied by a DXLink Power sourcing device such as an Enova DGX 8/16/32/64 Digital Media Switcher or compatible Enova DVX All-In-One Presentation Switcher (DVX-3155HD, 3156HD, or 2155HD), PS-POE-AT-TC High Power PoE Injector (FG423-84) or PDXL-2 Power over DXLink Controller (FG1090-170). AMX does <i>not</i> support the use of any other power supplies or PoE injectors as these may potentially damage the DXLink equipment. To use PS-POE-AT-TC as a power source the DX-TX Transmitter and the DX-TX-DWP and DX-TX-WP Transmitter Wallplates require firmware v1.2.40 or above. • DXLink Twisted Pair Receiver (DX-RX): Power can also be supplied by a DXLink Power sourcing device such as an Enova DGX 8/16/32/64 Digital Media Switcher or compatible Enova DVX All-In-One Presentation Switcher (DVX-2150HD, or 2155HD), PS-POE-AT-TC High Power PoE Injector (FG423-84), PDXL-2 Power over DXLink Controller (FG1090-170), or SDX-510M-DX Solecis 5x1 Multi-Format Digital Switcher (FG1010-315). AMX does <i>not</i> support the use of any other power supplies or PoE injectors as these may potentially damage the DXLink equipment. To use PS-POE-AT-TC as a power source the DX-RX Receiver requires firmware v1.0.80 or above. • Power Budget for Transmitters and Receiver: When installed in conjunction with the Enova DGX Digital Media Switcher, use the Enova DGX Configuration Tool located at www.amx.com/enova to determine the power requirements of the configuration and whether any of the DXLink Transmitters or Receivers should be powered with the local power supplies or the supported Power over DXLink injector. The configuration tool contains instructions on how to determine power requirements.
Power Consumption, Local 12 V Supplied (max.)	<ul style="list-style-type: none"> • DX-TX 10 W (13.5 V) • HDMI TX 9 W • DX-RX 18 W
Power Consumption, Enova DXLink Power Supplied (max.)	<ul style="list-style-type: none"> • DX-TX 10 W • HDMI TX 9 W • Wallplate TX 7 W • Decor Wallplate TX 7 W • DX-RX 15 W
Thermal Dissipation, Local 12 V Supplied (max.)	<ul style="list-style-type: none"> • DX-TX 34 BTU/hr. (13.5 V) • HDMI TX 31 BTU/hr. • DX-RX 61 BTU/hr.
Thermal Dissipation, Enova DXLink Power Supplied (max.)	<ul style="list-style-type: none"> • DX-TX 34 BTU/hr. • HDMI TX 31 BTU/hr. • Wallplate TX 24 BTU/hr. • Decor Wallplate TX 24 BTU/hr. • DX-RX 51 BTU/hr.
Power Connector (Modules Only)	2.1 mm DC power jack 
Operational Temperature	32° F to 104° F (0° C to 40° C)
Storage Temperature	-22° F to 158° F (-30° C to 70° C)
Operational Humidity	5 to 85% RH (non-condensing)
Storage Humidity	0 to 90% RH (non-condensing)
Module - Dimensions	
Depth	5.15 in. (13.08 cm)
Width	8.71 in. (22.12 cm)
Height	1.00 in. (2.54 cm)
Module - Weight	Approximately 1.1 lb. (0.50 kg)
Module - Shipping Weight	Approximately 2.2 lb. (1.00 kg)
Modules - Mounting Options	Compatible with all V Style versatile mounting options including rack, surface, or pole (for V Style Mounting kits, see www.amx.com)
Wallplate TX - Dimensions	
Depth	1.31 in. (3.33 cm)
Width	5.98 in. (15.20 cm)
Height	4.69 in. (11.90 cm)
Wallplate TX - Weight	Approximately 1.4 lb. (0.64 kg)
Wallplate TX - Shipping Weight	Approximately 2.0 lb. (0.91 kg)
Wallplate TX - Mounting Options	Wallplate TX mounts onto standard double-gang US, UK, or EU back boxes

General Specifications (continued)	
Decor Wallplate TX -Dimensions	
Depth	2.25 in. (5.72 cm)
Width	3.48 in. (8.84 cm)
Height	4.06 in. (10.31 cm)
Decor Wallplate TX - Weight	Approximately 0.75 lb. (0.34 kg)
Decor Wallplate TX - Shipping Weight	Approximately 1.35 lb. (0.61 kg)
Decor Wallplate TX - Mounting	Decor Wallplate TX mounts in standard double-gang US back box
MTBF	381,000 hours
Transport Layer Throughput	10.2 Gbps
Twisted Pair Cable Type	Shielded Cat6, Cat6A, Cat7*
Twisted Pair Cable Length	Up to 328 ft. (100 m)* IMPORTANT: <i>DXLink twisted pair cable runs for DXLink equipment shall only be run within a common building. "Common building" is defined as: Where the walls of the structure(s) are physically connected and the structure(s) share a single ground reference.</i> * For more details and helpful cabling information, reference the white paper titled "Cabling for Success with DXLink" available at www.amx.com or contact your AMX representative.
Modules - Airflow	Convection (openings on top of case)
Transmitters and Receiver Inter-compatibility	All DXLink Transmitters can connect directly to the DXLink DX-RX. The Wallplate TX and Decor Wallplate TX require either PDXL-2 (FG1090-170) or PS-POE-AT-TC (FG423-84) to do so.
Other AMX Equipment	
AMX Products Compatible with All DXLink Transmitters	<ul style="list-style-type: none"> • DX-RX • Enova DGX Digital Media Switchers • Enova DVX-3156HD • Enova DVX-3155HD • Enova DVX-2155HD
AMX Products Compatible with DXLink Receiver	<ul style="list-style-type: none"> • DX-TX • HDMI TX • Wallplate TX • Decor Wallplate TX • Enova DGX Digital Media Switchers • Enova DVX-3156HD • Enova DVX-3155HD • Enova DVX-3150HD • Enova DVX-2155HD • Enova DVX-2150HD • Solecis SDX-410-DX • Solecis SDX-510M-DX • Solecis SDX-810-DX
Included Accessories	Desktop power supply (ENERGY STAR® qualified): 1 per module IMPORTANT: <i>Only the provided desktop power supply should be used, and it <u>must not</u> be altered in any way.</i>
Compatible / Optional Equipment	<ul style="list-style-type: none"> • CC-NIRC NetLinx Emitter Cable (FG10-000-11) • IR03 External IR Receiver Module (FG-IR03) • PDXL-2 (FG1090-170) • PS-POE-AT-TC (FG423-84) • CC-USB, USB programming cable (FG10-5965) (for use with DXLink Twisted Pair Transmitters only)

COMPATIBILITY NOTE: *DXLink Transmitters and Receivers are compatible with other DXLink products (see the Compatible AMX Products listed in the table above). The Wallplate TX and the Decor Wallplate TX require an approved DXLink power injector (see table above) when connecting directly to an DX-RX (Transmitters require firmware v1.2.40 or later; Receivers require firmware v1.0.80 or later). AMX does not support the use of power supplies other than the one provided or power injectors other than those listed as they may potentially damage DXLink equipment.*

NetLinX and Control Specifications	
Parameter	Value
ICS LAN / Ethernet Port (Modules Only)	<ul style="list-style-type: none"> TCP/IP port (ICS LAN 10/100) RJ-45
Serial (Modules Only)	<ul style="list-style-type: none"> Bidirectional RS-232 Standard NetLinX baud rate 1200 to 115K Parity support: Odd/Even/None 3.5 mm pluggable Phoenix terminal block
IR Control (Modules Only)	<ul style="list-style-type: none"> Port for use with IR03 Receiver (optional accessory FG-IR03) Port for use with CC-NIRC Emitter (optional accessory FG10-000-11)
Advanced Configuration Interface	USB mini-B connector (Program port)
ID Pushbutton	<ul style="list-style-type: none"> Toggle between DHCP and static IP addressing Places system in NetLinX Device ID assignment mode Reset the factory default settings Restore the factory firmware image

USB (HID) Keyboard and Mouse Specifications	
Parameter	Value
USB (HID) DX-TX	<ul style="list-style-type: none"> (1) USB Type B connector ("Host") Connect a DXLink Twisted Pair TX to a PC and emulate keyboard and mouse commands from a DXLink Twisted Pair Receiver or a DXLink Fiber Receiver
USB (HID) Wallplate TX and Decor Wallplate TX	<ul style="list-style-type: none"> DX-TX-WP: (1) USB Mini-B ("Host"); DX-TX-DWP: (1) USB Mini-AB ("Host") Connect a DXLink Twisted Pair Decor Transmitter to a PC and emulate keyboard and mouse commands from a DXLink Twisted Pair Receiver or a DXLink Fiber Receiver
USB (HID) DX-RX	<ul style="list-style-type: none"> (1) USB Type A connector ("Device") Connect a keyboard and mouse and send commands to a PC connected to a DXLink Twisted Pair Transmitter or a DXLink Fiber Transmitter

NOTE: A list of HID devices which have been tested and found to be working well with the latest firmware is available (see "DXLink - HID supported Devices" on the DXLink Receiver's product page at www.amx.com).

HDMI Specifications	
Parameter	Value
Compatible Formats	HDMI, HDCP, DVI (DVI requires conversion cable)
Signal Type Support	HDMI, DVI-D (Single Link with a DVI-to-HDMI cable adapter), DisplayPort++ (input only with HDMI cable adapter)
Video Data Rate (max.)	4.95 Gbps / 6.75 Gbps*
Video Pixel Clock (max.)	165 MHz / 225 MHz*
Progressive Resolution Support	480p up to 1920x1200,60Hz (including but not limited to those resolutions listed on page 111 and page 114)
Interlaced Resolution Support	480i, 576i, 1080i (including but not limited to those resolutions listed on page 111 and page 114)
Deep Color Support	24 bit, 30 bit*, 36 bit*
Color Space Support	RGB 4:4:4 YCbCr ^{4:4:4} and 4:2:2 <ul style="list-style-type: none"> Input signal support for YCbCr 4:4:4 and 4:2:2; output color-space is converted to RGB 4:4:4.
3D Format Support	Yes (HDMI Primary Formats) <ul style="list-style-type: none"> Frame Packing 1080p up to 24 Hz Frame Packing 720p up to 50/60 Hz Frame Packing 1080i up to 50/60 Hz Top-Bottom 1080p up to 24 Hz Top-Bottom 720p up to 50/60 Hz Side-by-Side Half 1080i up to 50/60 Hz NOTE: Scaler on the corresponding output board or DX-RX must be set to Bypass mode.
Audio Format Support	Dolby TrueHD, Dolby Digital, DTS-HD Master Audio, DTS, 2 CH L-PCM, 6 CH L-PCM, 8 CH L-PCM <ul style="list-style-type: none"> Dolby Digital and DTS support up to 48 kHz, 5.1 channels.

* Only supported when the DX-RX scaler is in Bypass mode using CEA-861 formats and the resolution is 1080p,60 or less.

NOTE: Interlaced and progressive video are supported into the Transmitter; progressive is only supported out of the Receiver unless in non-scaling Bypass mode

HDMI Specifications (continued)	
Parameter	Value
Audio Resolution	16 bit to 24 bit
Audio Sample Rate	32 kHz, 44.1 kHz, 48 kHz, 96 kHz, 192 kHz
Local Audio Support	TX insertion, RX extraction
HDCP Support	Yes <ul style="list-style-type: none"> Supports AMX HDCP InstaGate Pro[®] Technology. When used with an Enova DGX 8/16/32/64 Digital Media Switcher or Enova DVX-2155 or DVX-3155, the key support is up to 16 sinks per output, independent of the source device. When used as a single point-to-point solution, key support is defined by the source device.
CEC support	CEC is not currently supported
TX	
Input Signal Type	<ul style="list-style-type: none"> HDMI DVI-D (Single Link with a DVI-to-HDMI cable adapter) DisplayPort ++ (input only with HDMI cable adapter)
DDC/EDID Support	<ul style="list-style-type: none"> The HDMI EDID in point to point mode is passed up from the sink device. When used with Enova DGX 8/16/32/64 Digital Media Switcher or Enova DVX-2155, DVX-3155, the HDMI EDID is passed from the Enova Switcher input to the TX and is user re-programmable. The analog video input connection provides a fixed EDID set. For the EDID list, see the specifications in the "Enova DGX DXLink Twisted Pair Boards" chapter in the <i>Hardware Reference Manual – Enova DGX 100 Series Digital Media Switchers</i> or the <i>Instruction Manual – Enova DGX 8/16/32/64 Digital Media Switchers</i>.
Input Voltage (nominal)	1.0 Vpp differential
Input Re-clocking (CDR)	Yes
Input Equalization	Yes, adaptive
Input Connector	HDMI Type A female
Propagation Delay (typical)	5 μ s
RX	
Output Signal Type	<ul style="list-style-type: none"> HDMI DVI-D (Single Link with a DVI-to-HDMI cable adapter)
Output Scaling	SmartScale [®] , Manual Configuration, Bypass
SmartScale [®] Output Resolution Support	All resolutions between 480p and 1920x1200,60Hz via automatic SmartScale [®] query of the display's preferred EDID detailed timing definition
Output Voltage (nominal)	1.0 Vpp differential
Output Re-clocking	Yes
+5 V DDC Pin Output	50 mA when using DXLink power, 500 mA when using local 12 V supply
+5 V USB Output	150 mA when using DXLink power, 500 mA when using local 12 V supply
Output Rise Time / Fall Time	425 ps typical (20% to 80%)
Output Connector	HDMI Type A female
Propagation Delay (typical)	25 ms when scaling; 5 μ s when in Bypass mode
HDMI Audio Synchronization	Video formats @ 60 Hz frame rate: In Scaling mode, audio leads video by 11 ms typical (3 ms to 19 ms). In Bypass mode, audio lags video by 14 ms.

Analog Video Specifications	
Parameter	Value
DX-TX, Wallplate TX, and Decor Wallplate TX	
Compatible Formats	<ul style="list-style-type: none"> RGBHV, RGBS, RGB Y/Pb/Pr (HDTV) Y/C (S-Video), C (Composite)
Progressive Resolution Support	480p up to 1920x1200,60Hz (supported resolutions are shown in the applicable manual's "Supported Input Resolutions" appendix)
Interlaced Resolution Support*	480i, 576i, 1080i (supported resolutions are shown in the applicable manual's "Supported Input Resolutions" appendix) NOTE: <i>Interlaced video is supported into the Transmitters; progressive is only supported out of the Receiver unless it is in Scaler Bypass mode.</i>

Analog Video Specifications (continued)	
Auto-Adjust Input	Supported
RGB Input Signal Level Range	1 Vpp nominal
RGB Input Impedance	75 ohm
HV Sync Input Signal Level Range	2 to 5 Vpp
HV Sync Input Impedance	2.5 pF typical, 10 pF max.
Digital Processing	24 bit, 165 MHz
Y/Pb/Pr Input Signal Level Range	<ul style="list-style-type: none"> • 1.0 Vpp for Y • 700 mVpp for Pb, Pr
Y/Pb/Pr Input Impedance	75 ohm
Y/C (S-Video) Input Signal Level Range	<ul style="list-style-type: none"> • 1.0 Vpp for Y • 1.0 Vpp for c
Y/C (S-Video) Input Impedance	75 ohm
C (Composite) Input Signal Level Range	1.0 Vpp
C (Composite) Input Impedance	75 ohm
Connector	HD-15 (breakout cable required for non-RGB formats)

Local Audio Specifications	
Parameter	Value
TX	
Input Signal Types	Stereo analog, S/PDIF* (Video signal <i>must</i> be present to pass audio)
Analog Input Level (max.)	+2 dBu, unbalanced
Analog Input Impedance	10 kohms
Analog to Digital Conversion	48 kHz sample rate, 24-bit
S/PDIF Audio Format Support	Dolby Digital, DTS, 2 CH L-PCM
S/PDIF Resolution*	16 to 24 bit
S/PDIF Sample Rate*	32 kHz, 44.1 kHz, 48 kHz, 96 kHz
S/PDIF Input Signal Level Range*	200 mVpp to 600 mVpp terminated
S/PDIF Input Impedance*	75 ohm
Analog to Digital Reference Level	+2.5 dBu = 0 dBfs
Connector	<ul style="list-style-type: none"> • 3.5 mm mini-stereo jack (analog stereo) • RCA jack (S/PDIF)*
RX	
Output Signal Types	Stereo analog
Analog Output Level (max.)	+2 dBu, unbalanced; ≥ 3 kohm load
Analog Output Frequency Response	<+0 dB to -0.5 dB, 20 Hz to 20 kHz
Analog Audio Output THD+N	<0.03%, 1 kHz, -10 dBu to +2 dBu
Analog Audio Out SNR	>85 dB, 20 Hz to 20 kHz, Vin = +2 dBu
Audio Synchronization	Video formats @ 60 Hz frame rate: In Scaling mode, audio leads video by 11 ms typical (3 ms to 19 ms). In Bypass mode, audio lags video by 14 ms.
Connector	3.5 mm mini-stereo jack (analog stereo)

* S/PDIF specifications do not apply to the Wallplate TX or to the Decor Wallplate TX.

AMX reserves the right to modify its products and their specifications without notice.

Installation and Setup

Site Recommendations

When placing the DXLink Transmitters and Receivers in an installation, follow the recommendations and precautions in this section to reduce potential setup and operation hazards.

Environment

- Choose a clean, dust free, (preferably) air-conditioned location.
- Avoid areas with direct sunlight, heat sources, or high levels of EMI (Electromagnetic Interference).

DX-TX, HDMI TX and DX-RX Accessibility

Make sure the front of each module is accessible, so that you can monitor the LED indicators. Leaving adequate clearance at the rear will also allow for easier cabling and service.

Power

The power source's electrical outlet should be installed near the module, easily accessible, and properly grounded. Power should come from a building branch circuit. To avoid an overload, note the power consumption rating of all the equipment connected to the circuit breaker before applying power.

General Hazard Precautions

These recommendations address potential hazards that are common to all installations.

IMPORTANT: *DXLink twisted pair cable runs for DXLink equipment shall only be run within a common building. "Common building" is defined as: Where the walls of the structure(s) are physically connected and the structure(s) share a single ground reference.*

Elevated Operating Temperature

The maximum rated ambient temperature is 104° F (40° C) for DXLink Transmitters and Receivers. All equipment should be installed in an environment compatible with the manufacturer's maximum rated ambient temperature. In a closed or multi-unit rack assembly, the operating ambient temperature of the rack environment may be greater than the ambient room temperature.

CAUTION: *To protect the equipment from overheating, do not operate in an area that exceeds 104° F (40° C) and follow the clearance recommendation below for adequate airflow.*

Airflow Restriction

The modules are designed to adequately dissipate the heat they produce under normal operating conditions; however, this design is defeated when high heat producing equipment is placed directly above or below the modules.

CAUTION: *To prevent overheating, avoid placing high heat producing equipment directly above or below the modules. We recommend allowing plenty of clearance above the vent holes on top of the modules. Do not place anything directly on top of the modules that would restrict airflow through the vent holes on top.*

Reliable Earthing (Grounding)

Reliable earthing of rack-mounted equipment should be maintained. If not using a direct connection to the branch circuit (e.g., plugging into a power strip), pay particular attention to supply connections (not applicable when power is supplied from an Enova DGX Digital Media Switcher or Enova DVX Solution via a DXLink line). When using DXLink Power from a switcher, we recommend wiring a technical ground for the ungrounded sources/destinations with respect to the DXLink Transmitters/Receivers and switcher (see page 37).

Unpacking Tips

- Before fully unpacking the Transmitters and Receivers, inspect the shipping box(es) for any signs of damage. If a box is partially crushed or any sides have been broken open, notify the shipping agency immediately and contact your AMX representative (see the warranty at www.amx.com).
- Once unpacking is complete, closely check the physical condition of the units.
- Collect all documentation.

NOTE: *Please save the original shipping container and packing materials. AMX is not responsible for damage caused by insufficient packing during return shipment to the factory. Shipping boxes are available; for details, contact your AMX representative.*

Setup Information

IMPORTANT: *The setup information in this manual applies to TXs and RXs in an Enova DGX 8/16/32/64 system or in an Enova DGX 100 Series system with the auto-setup feature disabled. When the auto-setup feature for an Enova DGX 100 Series Switcher is enabled (the default), any modules or wallplates are automatically discovered and connected to the switcher using a private network hosted by the integrated Master (for complete information, see the "Hardware Reference Manual – Enova DGX 100 Series Digital Media Switchers"). In an Enova DGX 8/16/32/64 system, each module or wallplate bound to the system with traditional NetLinx binding (see page 52) acquires its own IP address from the public network (for network configuration, see page 52).*

Setup Requirements

- A PC with NetLinx Studio v4.0 or later installed.
- An understanding of which DXLink Mode the system will be used in (see below and page 31).
- An understanding of the DIP switch settings (see page 36).
- When used with an Enova DGX Digital Media Switcher the system's power requirements must be determined (see page 31).
- When used with an Enova DVX Solution – The SEND_COMMANDS for enabling network activity (Ethernet traffic) over the DXLink line must be used (see page 82).

IMPORTANT: We recommend that DXLink equipment be installed by a technician with knowledge of networks and experience with NetLinx Studio and its Telnet interface. NetLinx experience should include changing device addresses, binding devices, updating firmware, etc.

The remainder of the “Setup Information” section covers information for system setup, power budget planning, network loop concerns, binding to an integrated Master, DIP switch settings, mounting options, chassis grounding, cable requirements and recommendations (including RJ-45 pinouts and LED behavior), and audio type precedence.

The specific installation's requirements dictate the system setup, which generally takes one of the following three forms.

- Endpoint Mode (Switcher) – One or more Transmitters and/or Receivers are connected to a switcher* containing a Master (see below).
- Endpoint Mode (Standalone) – A standalone DXLink TX/RX pair are connected directly to each other but, in addition, either the TX or RX is connected to a NetLinx Central Controller via a LAN or directly to the Controller (see page 30).
- Extender Mode (Standalone) – A standalone DXLink TX/RX pair are connected directly to each other as a simple extender solution (see page 31).

* The switcher can be either an Enova DGX Switcher or an applicable Enova DVX Solution (see “Product Compatibility Tables” on page 8).

Endpoint Mode (Switcher): Example of Typical System Setup

The primary function of the Transmitters and Receivers is to work with compatible DXLink equipment as an endpoint solution for transmission of HDMI over twisted pair cable (or DVI-D signals with the use of a DVI-to-HDMI cable adapter, or analog video signals through a DX-TX, Wallplate TX, or Decor Wallplate TX).

The Transmitter receives an HDMI signal and an audio signal from a source device. The audio can be either digital audio embedded with the HDMI signal, digital audio over S/PDIF (S/PDIF is not available on the Wallplate TX or Decor Wallplate TX), or analog stereo audio. Both the video and embedded audio are transmitted over twisted pair cable to the RJ-45 connector on the DXLink Input Board. The HDMI signal is then routed through any (or all) of the connectors on one or more output boards.

When the HDMI signal is routed through a DXLink Output connector to a Receiver, the Receiver sends the HDMI signal with embedded audio on to the destination device. The audio can also be output on the Receiver's stereo audio port.

In systems where DXLink Transmitters and Receivers are used in conjunction with a switcher (e.g., Enova DGX 16), the cable runs from a Transmitter to a DXLink Input Board and from a DXLink Output Board to a Receiver can each be up to 328 feet (100 m).

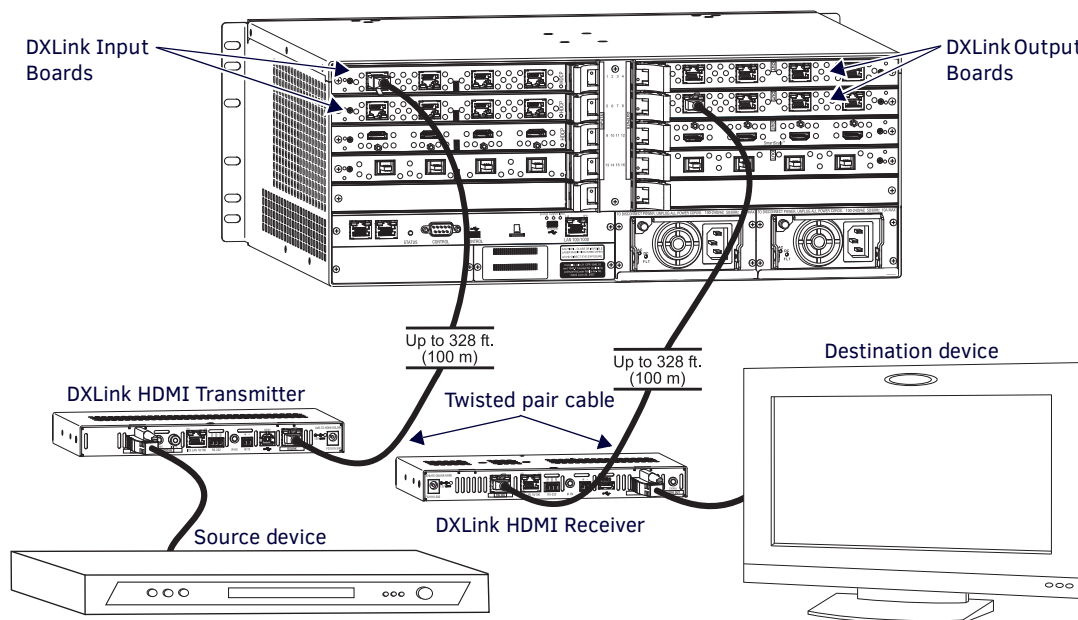

FIG. 13 Endpoint Mode (Switcher) setup with Enova DGX 16

TIP: For systems with special requirements – Before installing in the final location, place the equipment close together, so that the destination monitor and a PC for control can be seen simultaneously if adjustments are necessary. Scaling adjustments can be made using SEND_COMMANDs (see page 64). For Enova DGX 8/16/32/64 Switchers, DGX Configuration Software can also be used to make scaling adjustments via the switcher (see the switcher’s manual). For Enova DGX 100 Series Switchers, scaling can also be adjusted via the System Configuration interface (see the switcher’s manual).

CAUTION: Be careful not to create a network (Ethernet) loop. To avoid doing so, see page 33.

Custom EDID Settings

- If Transmitters are part of an Enova DGX system which requires custom EDID settings, see the switcher’s manual for information on the EDID programming functionality in DGX Configuration Software (available at www.amx.com). SEND_COMMANDs can also be used (see page 64).
- If Receivers are part of an Enova DGX 8/16/32/64 system which requires scaler control and settings, see the switcher’s manual for information on the scaling functionality in DGX Configuration Software (available at www.amx.com). SEND_COMMANDs can also be used (see page 64).

Options for System Setup with Enova DGX DXLink Boards

The following table contains options for using DXLink Transmitters and Receivers in conjunction with DXLink Twisted Pair Input and Output Boards in an Enova DGX Digital Media Switcher.

System Setup Options – Enova DGX DXLink Boards with DXLink Transmitters/Receivers			
DXLink Module/Wallplate	Input Board	Output Board	DXLink Module
DX-TX Module →	DXLink Twisted Pair →	DXLink Twisted Pair →	DX-RX Module
DX-TX Module →	DXLink Twisted Pair →	Any board* →	Not applicable
HDMI TX Module →	DXLink Twisted Pair →	DXLink Twisted Pair →	DX-RX Module
HDMI TX Module →	DXLink Twisted Pair →	Any board * →	Not applicable
Wallplate TX →	DXLink Twisted Pair →	DXLink Twisted Pair →	DX-RX Module
Wallplate TX →	DXLink Twisted Pair →	Any board* →	Not applicable
Decor Wallplate TX →	DXLink Twisted Pair →	DXLink Twisted Pair →	DX-RX Module
Decor Wallplate TX →	DXLink Twisted Pair →	Any board* →	Not applicable
Not Applicable	Any board* →	DXLink Twisted Pair →	DX-RX Module

* If the board is an SC Optical Board in an Enova DGX Digital Media Switcher, it will need the appropriate DGX Fiber Module. For information, see the DGX Fiber Module’s manual.

Options for System Setup with Enova DVX Solutions

The following table contains options for using DXLink Transmitters and Receivers in conjunction with DXLink Input and Output connectors on Enova DVX Solutions. Note that on the input side, four Transmitter options are available. The Transmitters used with the inputs can be of the same type or different, depending on the installation needs.

Unless otherwise indicated, the Enova DVX Solutions in the table below have 2 DXLink input and/or output connectors.

System Setup Options – Enova DVX DXLink Solutions with DXLink Transmitters/Receivers			
DXLink Module/Wallplate Options	Enova DVX Solution		DXLink Module
.....	DVX-3155HD DVX-2155HD** DVX-3156HD***	
DX-TX Module → HDMI TX Module → Wallplate TX → Decor Wallplate TX →	DXLink Input connector →	DXLink Output connector →	DX-RX Module
.....	DVX-3150HD	
NA	NA	DXLink Output connector →	DX-RX Module
.....	DVX-2150HD**	
NA	NA	DXLink Output connector →	DX-RX Module

** These Enova DVX models have 1 DXLink output connector each.

*** The Enova DVX-3156HD has 4 DXLink inputs and 2 DXLink outputs.

Functions of DXLink Transmitters and Receivers

The diagram in FIG. 14 shows the functions of DXLink Transmitters and Receivers. The example descriptions contain the device HDCP key count when used in conjunction with DXLink Boards in an Enova DGX Digital Media Switcher and when using a Transmitter and Receiver as a standalone pair.

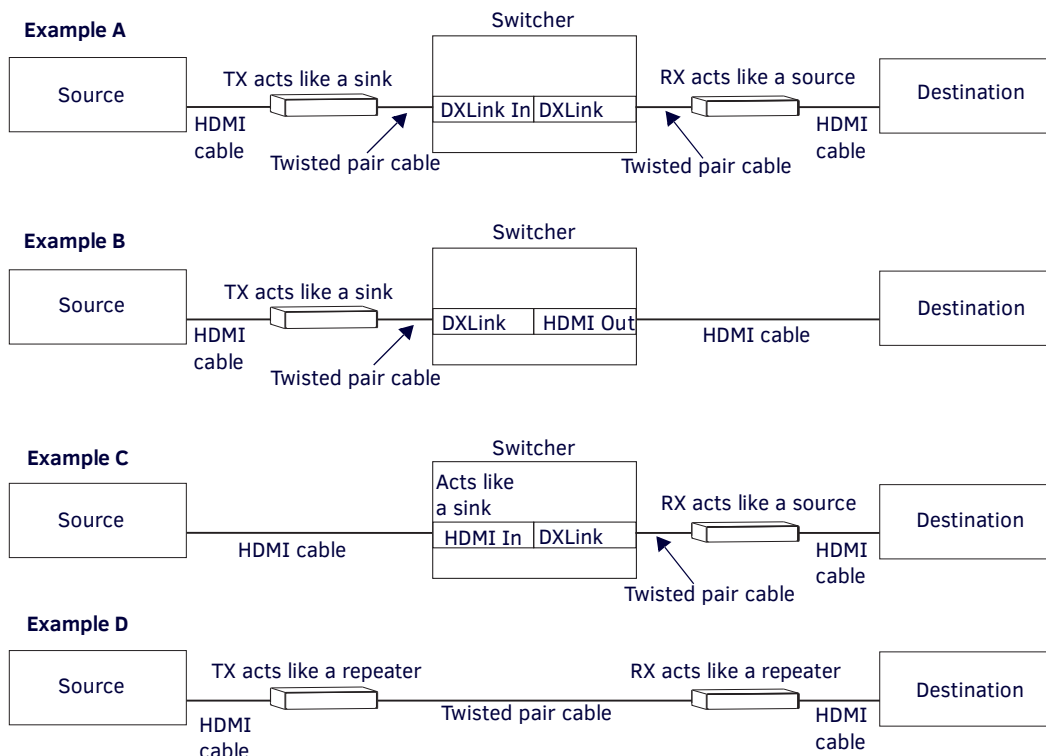

Example A: When a Receiver acts like a source, its key does not count. Source device sees 1 key (Transmitter).
Example B: When a Transmitter acts like a sink, the source device sees 1 key (Transmitter).
Example C: When a source device is connected directly to a switcher, the source sees 1 key (switcher input).
Example D: When a Transmitter is part of a standalone pair, its key does not count. Source device sees 2 keys.

FIG. 14 Repeater and source functions of TX/RX Modules (A, B, D also apply to Wallplate TX and Decor Wallplate TX)

Endpoint Mode (Standalone): Example of Typical System Setup

A standalone DXLink TX/RX pair are connected directly to each other but, in addition, either the TX or RX is connected to a NetLinX Central Controller via a LAN or directly to the Controller.

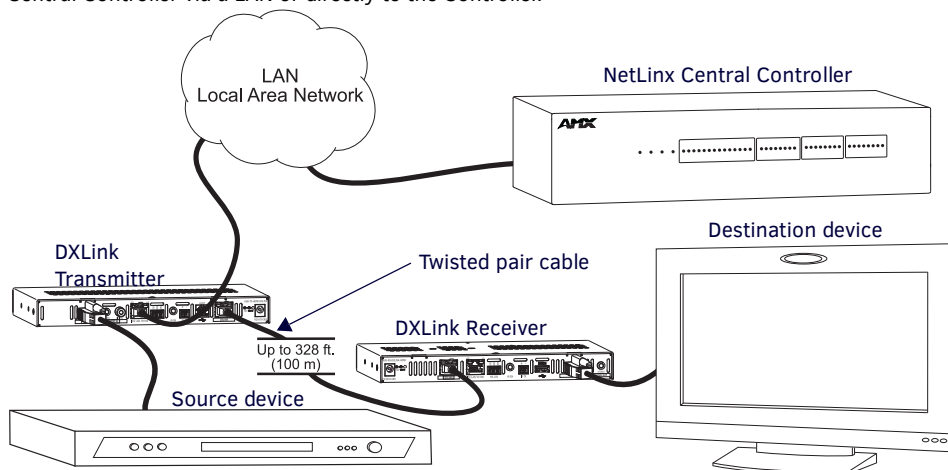

FIG. 15 Endpoint Mode (Standalone) with NetLinX Central Controller

Extender Mode (Standalone): Example of Typical System Setup

A Transmitter and Receiver standalone pair can also work together as an extender solution for transmission of HDMI over twisted pair cable up to 328 feet (100 m). The standalone setup supports DVI-D signals with the use of a DVI-to-HDMI cable adapter. A DX-TX and DX-RX pair can also support an analog video source.

In systems with a Wallplate TX or Decor Wallplate TX, power can be provided to the units via the DXLink line by connecting a DXLink power injector to the Wallplate and using either the desktop power supply or another DXLink power injector with the DX-RX.

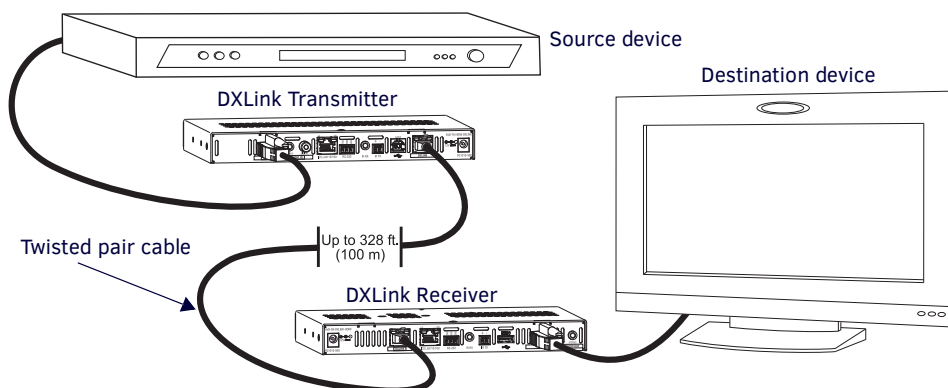

FIG. 16 Extender Mode (Standalone) system

Important Power Considerations for Enova DGX Systems

- **Local power** – Local power (the desktop power supply) always takes precedence over power via the DXLink line from the switcher. However, if a locally powered unit is connected to a switcher and the local power is lost (i.e., unplugged or turned off), the unit will power down and then automatically power back up using power from the switcher via the DXLink connection (increasing the overall power draw on the switcher). When local power is restored, it automatically replaces the power over the DXLink line.
- **DXLink power** – When modules are being powered by an Enova DGX DXLink board, PDXL-2, or PS-POE-AT-TC (using power via the DXLink line), to maintain the switcher's power redundancy, we recommend that you:
 - Determine the power budget based on the Input/Output boards used and the quantity of powered endpoints (modules); see below.
 - Do *not* use the local DC power jack on the module (even if the local power adapter is turned off).

NOTE: When using DXLink Power from an Enova DGX Switcher, we recommend wiring a technical ground for ungrounded sources/destinations with respect to the DXLink Transmitters/Receivers and switcher (see page 37).

Power Budget Planning for System Setup with an Enova DGX

NOTE: This section does not apply to the Enova DVX Solutions due to their minimal number of DXLink connections.

Before installing an Enova DGX Digital Media Switcher and connecting any required DXLink Transmitters and Receivers, the total power draw for the system should be calculated in order to maintain the redundancy of the power supplies in the enclosure. (Each Enova DGX enclosure ships with two mutually-redundant power supplies.)

IMPORTANT: If you do not plan to draw power from the Enova DGX enclosure's power supplies, you **must** power the DXLink Transmitter and Receiver Modules with local power (desktop power supply) or remote power (DXLink power injector), which always overrides power from the switcher. If that power source is turned off, the DXLink Transmitters and Receivers will reboot and then start drawing power from the switcher.

Power Budget Calculation

Calculating the power budget helps determine how many DXLink Transmitters and Receivers can be powered through the Enova DGX Digital Media Switcher while maintaining power redundancy if one of the power supplies should fail. The *Enova DGX Configuration Tool* is used to determine the switcher's power budget. Simply enter the types of boards and the number of DXLink Transmitters and Receivers to be powered through the switcher, and the calculator shows the resulting power draw. The *Enova DGX Configuration Tool* is at www.amx.com/enova.

If more DXLink units are required than the switcher can support while maintaining redundancy, any DXLink Modules can be powered using the provided desktop power supplies or DXLink Power Injectors: PDXL-2 (FG1090-170) or PS-POE-AT-TC (FG423-84).

Wallplate and Decor Wallplate Transmitters *must* be included in the power calculations unless they are being powered by a DXLink power injector (*must* be AMX approved).

IMPORTANT: AMX does not support the use of any power supplies other than the provided ones or power injectors other than the ones approved as they may potentially damage the DXLink equipment.



Foregoing Power Supply Redundancy

Depending on particular Enova DGX input and output board configurations, operating over the redundant power supply level may be necessary on a permanent basis for some installations. While foregoing the benefits associated with a redundant power supply should be understood, operating without redundancy is in no way detrimental to the system, as long as both power supplies are operational. In this case, necessary power will be pulled evenly from both supplies. However, the loss of one power supply will result in the system being non-operational from a normal “non-redundant” system capability perspective.

In the Event of a Power Supply Failure

If an Enova DGX power supply fails, check the table below to determine which condition* applies and any actions that may be required:

System	Condition	Result/Required Action
Enova DGX 8/16 and 800/1600	Within power budget	The system will continue to run; okay to leave it powered until the failed power supply is replaced.
	Over power budget	The system will continue to run; however, we do not recommend leaving it powered until the failed power supply is replaced, unless enough DXLink Transmitter or Receiver Modules are removed (or otherwise powered) to bring the system's power budget within its maximum limit. (Another option is to remove some of the input and/or output boards.)
Enova DGX 32 and 3200	Within power budget	The system will continue to run; okay to leave it powered until the failed power supply is replaced.
	Over power budget	The remaining power supply will turn off. If enough DXLink Transmitter or Receiver Modules are removed (or otherwise powered) to bring the system's power budget within its maximum limit, the system will be able to run until the failed power supply is replaced. (You can also remove some input and/or output boards.)

In all of the situations above, the power supply should be replaced as soon as possible to restore power redundancy to the system or to allow the system to become fully operational again. Unless the Enova DGX Digital Media Switcher has exceeded its power budget, it should operate normally with a failed power supply.

* The over power budget condition does not apply to Enova DGX 64/6400 Switchers (which have four power supplies).

For additional information on power supplies and power supply troubleshooting for an Enova DGX Switcher, see the *Installation Manual – Enova DGX 8/16/32/64 Digital Media Switchers* or *Hardware Reference Manual – Enova DGX 100 Series Digital Media Switchers* at www.amx.com. For power supply replacement information, contact technical support (see page 86).

Avoiding Network (Ethernet) Loops

CAUTION: Be careful not to create a network (Ethernet) loop.

Only one connection to a LAN is permitted within a switching system with DXLink support. *Network loops must be avoided* (see FIG. 17). This applies to systems with DXLink Twisted Pair Modules **and/or** DXLink Fiber, Duplex units in Bidirectional Mode.

Example

In the example in FIG. 17, a network loop was created when the Enova DGX 16 was connected to a LAN and one of its DXLink Transmitters was connected to the same LAN. The DXLink Transmitter *must* be disconnected from the LAN. The same problem would also occur if an enclosure and one (or more) of its DXLink Receivers were connected to a common LAN. *Remember to avoid network loops.*

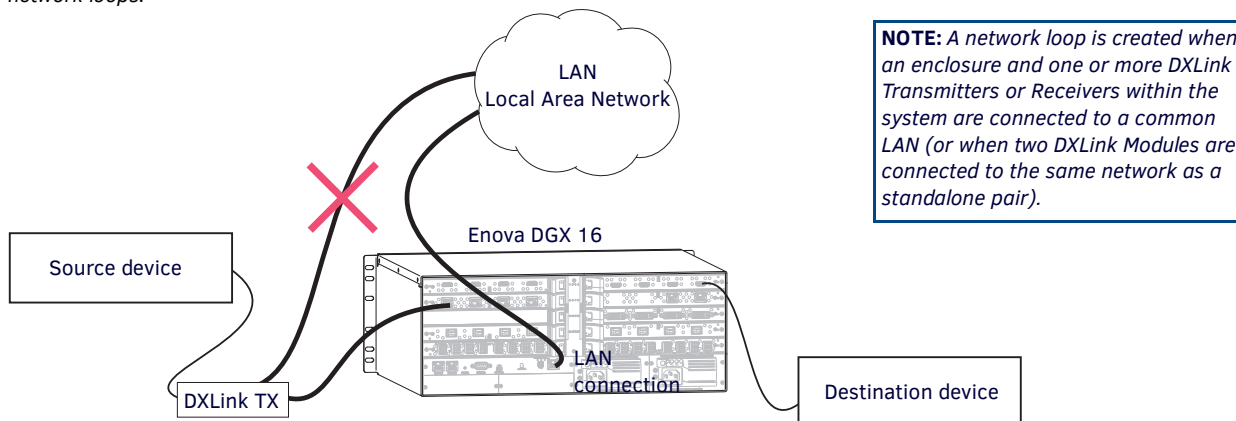

FIG. 17 Avoid network loops

NetLinx Binding of DXLink Modules or Wallplates with an Enova DGX/DVX

NOTE: If a DXLink module or wallplate has been configured for auto-setup mode and then auto-setup mode has been disabled, the unit may take longer to appear in NetLinx Studio than expected (1-2 minutes).

DXLink Transmitters and Receivers *must* have their DIP switch toggles set before they will display as part of an Enova DGX system in NetLinx Studio (v4.0 or later is required). DIP switch information, including settings for common scenarios, is on the next three pages.

In NetLinx Studio, the DXLink TXs and RXs can be bound to the integrated Master by right-clicking on the device and selecting Network Bind/Unbind Device. This is considered the traditional method of binding. If the integrated Master runs on a 100 Series CPU, see the *Hardware Reference Manual – Enova DGX 100 Series Digital Media Switchers* for auto-setup information (which does not require binding).

To bind DXLink units to Enova DGX integrated Master:

1. Verify the following:
 - a. Verify that an Ethernet/RJ-45 cable is connected from the Enova DGX Switcher's integrated Master to the network (e.g., from the switcher's LAN 100/1000 port to a LAN).
 - b. Verify that the target Transmitter or Receiver is connected via its DXLink connector to a DXLink Input or Output Board (respectively) on the switcher.
 - c. Verify that the switcher is powered on.
2. Launch NetLinx Studio and open the OnLine Tree.
3. Bind the target Transmitter or Receiver to the integrated Master:
 - a. Select and right-click the TX or RX.
 - b. From the context sensitive menu, select Network Bind/Unbind Device (be sure the check box is selected).
 - c. Click OK.

DIP Switch Location

TIP: For easiest access to the DIP switch toggles, we recommend setting them before installation.

DIP switch toggles for enabling/disabling special Receiver/Transmitter functionality are located on the bottom of the Receiver and the Transmitters (FIG. 18), on the rear of the Wallplate TX (left in FIG. 19), and on the front of the Decor Wallplate TX (right in FIG. 19).

NOTE: DIP switch settings on any of these DXLink products are read only on reboot. After the settings are read, any adjustments of the toggles will not be implemented and will not affect the system.

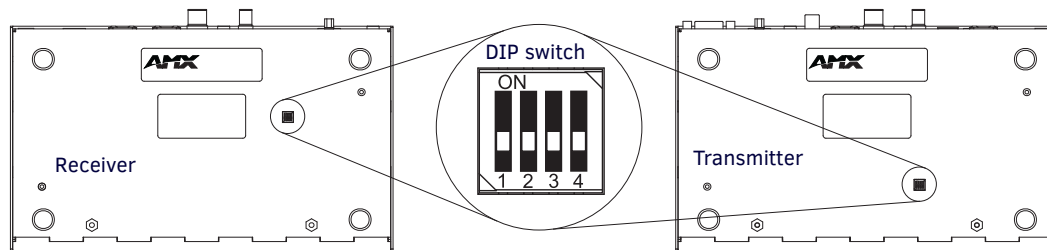

FIG. 18 DIP switch on bottom of Receiver and Transmitters

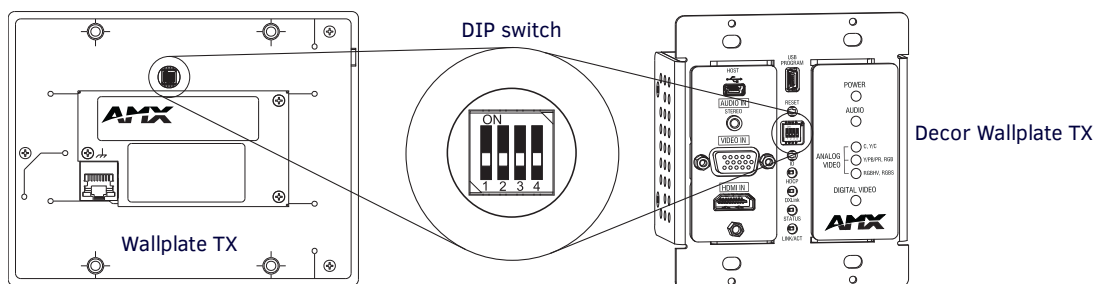

FIG. 19 DIP switch on rear of Wallplate TX (remove mounting bracket) and front of the Decor Wallplate TX

Setting DIP Switch #1 to Enable/Disable Access to ICS LAN 10/100 Port

The #1 Toggle is used for enabling/disabling network activity over the physical ICS LAN 10/100 port, which allows Ethernet passthrough. It does not affect network activity over DXLink. (For SEND_COMMANDS to disable/enable ICS LAN functionality, see page 79.)

NOTE: #1 Toggle settings do not apply to Wallplate TX & Decor Wallplate TX – leave #1 Toggle OFF.

TIP: Common setup scenarios and their DIP switch settings are provided in a table on page 36.

#1 Toggle Settings

- **OFF** (default) – When the #1 Toggle is set to OFF, network activity over the ICS LAN 10/100 port is disabled.
- **ON** – When the #1 Toggle is set to ON, network activity over the ICS LAN 10/100 port is enabled.

Installation Options

- Option A – For a network connection between a Transmitter and a Receiver where only one of them is connected to a LAN, set the #1 Toggle to ON for the unit that is connected to the network.

CAUTION: Option A – *Do not connect both the Transmitter and the Receiver to a common LAN as a network loop will result. For information on avoiding network loops, see page 33.*

- Option B – When a Transmitter or Receiver is connected to a DXLink input or output on an Enova DGX Digital Media Switcher or Enova DVX switcher, the switcher provides a network connection allowing the Transmitter or Receiver to appear in the online tree in NetLinX Studio (#3 Toggle *must* be set to ON). For connecting the Transmitter or Receiver to other equipment using the ICS LAN 10/100 port, the #1 Toggle *must* be set to ON.

CAUTION: Option B – *Because the DXLink connection carries network activity passed from the switcher, do not connect the ICS LAN 10/100 port on the Transmitter or Receiver to the same LAN as the switcher because a network loop will result. For information on avoiding network loops, see page 33.*

Setting DIP Switch #2 to Set the DXLink Mode

#2 Toggle can be set to automatically or manually select the DXLink Mode (to either Extender or Endpoint) for a given Transmitter/Receiver Module. Default state for #2 Toggle OFF is auto selection of DXLink Mode based on connection to another device. When it's ON, the default is Endpoint Mode (used for Master controlled serial/IR data transfer).

NOTE: #2 Toggle settings do not apply to Wallplate TX & Decor Wallplate TX – leave #2 Toggle OFF.

TIP: Common setup scenarios and their DIP switch settings are provided in a table on page 36.

#2 Toggle Settings

- OFF (default) – When #2 Toggle is set to OFF, the Transmitter and Receiver will each auto-discover* what type of DXLink equipment they are connected to and will automatically self-configure to be in one of two DXLink Modes based on the connection:
 - Extender Mode – This mode is automatically selected when a TX and RX are connected directly to each other (a standalone pair). The Transmitter and Receiver act like a simple extender, and serial and IR data is passed through them.
 - Endpoint Mode – This mode is automatically selected when a module is connected directly to a DXLink port on a switcher. Serial and IR operations are handled by the host providing control of endpoints. The Master's programming specifies where IR and serial commands are sent (this is handled independently from the routing of the video signals).

* Any time the DXLink connection is re-established or power is cycled on a module, the auto-discovery process will take place, as long as the #2 Toggle remains in the OFF position.

- ON – When #2 Toggle is set to ON, the auto-discover feature is disabled and the module can be manually set to either Endpoint Mode (default) or Extender Mode. In Endpoint Mode, when the module is connected to a switcher or a separate NetLinx Master**, IR and serial operation are only handled via the host.

** When standalone modules require IR and/or Serial control by a separate NetLinx Master, then they need to be in Endpoint Mode. Only one *must* be connected via the ICS LAN 10/100 port to the Master or to a LAN with the Master on it. This requires #1 Toggle to be ON to enable the ICS LAN port. #2 Toggle needs to be ON to place the modules in Endpoint Mode (if needed), and #3 Toggle needs to be ON to enable network connectivity.

NOTE: On either setting, the DXLink Mode may be set via SEND_COMMANDs (see page 79). When #2 Toggle is set to the OFF position, the auto-discovery process will overwrite the DXLink Mode setting. However, when the #2 Toggle is set to the ON position, auto-discovery is disabled and the mode set by SEND_COMMANDs will persist (i.e., the DXLink Mode setting cannot be overwritten).

Setting DIP Switch #3 for Network Connectivity

The #3 Toggle is used for enabling/disabling network connectivity (IP addressing) of the DXLink Transmitter or Receiver. If enabled it allows the Transmitter or Receiver to be configured to connect to a NetLinx Central Controller (used for controlling the DXLink unit and allowing Ethernet traffic).

NOTE: Wallplate TX – Before the DIP switch toggles can be set, the mounting bracket must be removed (unscrew the four screws from the bracket and set it aside). Decor Wallplate TX – Set switches before adding customer provided decor style front cover plate (requires four screws).

TIP: Common setup scenarios and their DIP switch settings are provided in a table on the next page.

#3 Toggle Settings

- OFF (default) – When the #3 Toggle is set to OFF, the Transmitter or Receiver will not try to connect to the network and will not acquire an IP address.
- ON – When the #3 Toggle is set to ON, the Transmitter or Receiver will attempt to connect to the network via DHCP or static IP, depending on how the unit has been set up (see page 49). The Transmitters and Receivers will not display in NetLinx Studio and will not accept commands or queries unless the #3 Toggle is ON.

NOTE: After the #3 Toggle is set to ON, a network connection is established, and the NetLinx Studio screen is refreshed, Transmitters and Receivers display in the OnLine Tree as Unbound NDP (Network Detect Proxy) Devices. To facilitate IRL and KIT file transfers, they can be bound to the integrated NetLinx Master in a switcher or to another NetLinx Master. A Virtual NetLinx Master can also be used for file transfers.

Scenarios / DIP Switch Settings Table

The table below contains the most common scenarios for setting up Transmitters and Receivers as a standalone pair or with other equipment. **Find the scenario in the table that you want to use and then set the Dip switches accordingly.** A detailed explanation of functions for each toggle is provided above and on the previous page.

NOTE: The #1 and #2 Toggles do not apply to the Wallplate TX and Decor Wallplate TX.

TIP: Each toggle's ON position is toward the connectors on the rear of the DXLink Modules or toward the top of the unit for the DXLink Wallplate TX and Decor Wallplate TX (see page 34).

Common Scenarios	DIP Switch Toggle Settings			
	1	2	3	4
Standalone Setup – TX/RX pair direct connection				
AV signals only (plus serial/IR passthrough)	OFF	OFF	OFF	OFF
AV with Ethernet passthrough to networked device* (plus serial/IR passthrough)	ON	OFF	OFF	OFF
AV with NetLinx control of TX/RX unit and serial/IR ports**	ON	ON	ON	OFF
AV with NetLinx control of TX/RX unit and serial/IR ports, plus Ethernet passthrough to networked device*	ON	ON	ON	OFF
Switcher Setup – TX/RX with Enova DVX/DGX Switcher				
AV signals only	OFF	OFF	OFF	OFF
AV with Ethernet passthrough to networked device*	ON	OFF	OFF	OFF
AV with NetLinx control of TX/RX unit and serial/IR ports	OFF	OFF	ON	OFF
AV with NetLinx control of TX/RX unit and serial/IR ports, plus Ethernet passthrough to networked device*	ON	OFF	ON	OFF

* Connect the ICS LAN 10/100 port of the DXLink unit to the network device (e.g., laptop, IP controlled projector, AMX ICS Lan EXB Device). In a standalone setup, connect the ICS LAN 10/100 port of the other DXLink unit to the network.

** In a standalone setup using NetLinx control of the DXLink serial/IR ports, only one of the DXLink units should be connected to the network (the unit with #1 Toggle enabled).

IMPORTANT: When connecting a Transmitter or a Receiver in a standalone pair setup to a Master (or Virtual Master) for upgrade purposes, #1 and #3 Toggles must be ON. #2 is only required on each module if serial and/or IR control is required from the Master.

Mounting Options for Modules (Rack Trays and Mounting Brackets)

CAUTION: To prevent overheating, avoid placing high heat producing equipment directly above or below the modules. We recommend allowing plenty of clearance above the vent holes on top of the modules. Do not place anything directly on top of the modules that would restrict airflow through the vent holes on top.

The DX-TX, HDMI TX, and DX-RX are classified as V Style modules, which have optional V Style mounting hardware. These versatile mounting options include rack trays and mounting brackets for desktops, under desks, on walls, and on poles. For details on V Style Mounting Kit options, see www.amx.com.

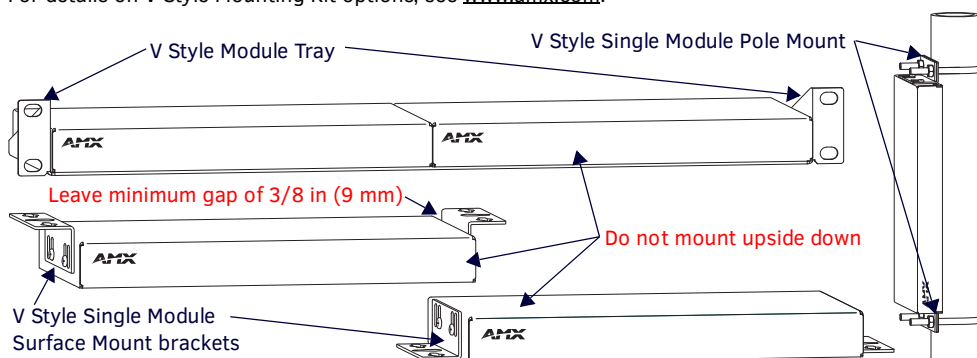

FIG. 20 V Style mounting hardware

IMPORTANT: When mounting under a surface, the module should be mounted upright and lowered in the slots to provide an airflow gap between the surface and the vent holes. If not using V Style brackets, be sure to leave a gap between the top of the unit and the surface for heat to escape.

Mounting Options for Wallplates

Wallplate TX – The holes in the Wallplate TX's mounting bracket are designed to accommodate a variety of double-gang back boxes using two or four screws. Two types of screws are provided: standard and metric. Be sure to orient the mounting bracket as shown in FIG. 21.

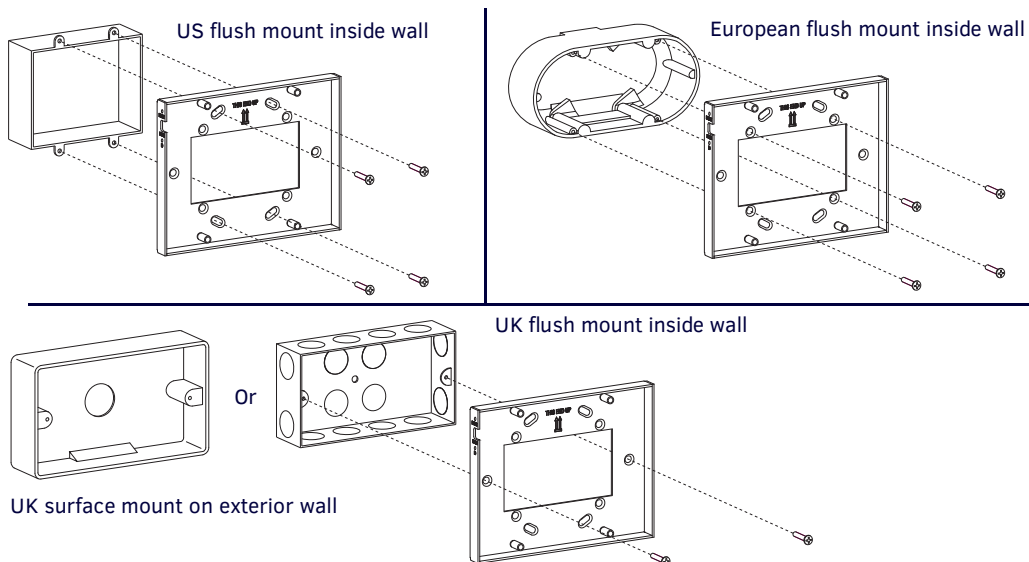

FIG. 21 Wallplate mounting bracket used with variety of double-gang back boxes

Decor Wallplate TX – The Decor Wallplate TX mounts in a standard US double-gang back box. Standard decor style cover plates are customer provided to allow matching the individual decor of an environment or matching other standard decor covers in a room/area.

IMPORTANT: Be sure to measure the back box and any other components used to mount the Decor Wallplate TX prior to installation/construction to ensure the unit fits (e.g., some mud rings do not work unless their corners are modified).

Attaching a Ground Wire to DXLink Transmitters/Receivers

NOTE: Technically this type of grounding is only required when a DXLink Transmitter or Receiver is connected to an ungrounded device, but this added grounding measure can be used at the discretion of the installer.

If the system is experiencing problems with delivery of DXLink signals to/from an Enova DGX Digital Media Switcher or Enova DVX Solution, adding a ground wire from the TX/RX to the switcher may improve performance. The problem is likely caused by the use of a single phase powered system that does not provide an earth ground for a source or destination's chassis and shields. This can inject unnecessary AC voltage on the HDMI cable shield that can lead to DXLink signal integrity issues. To check for indications of this type of power in the system, look for a two pronged plug or a cord that has only two wires.

Items Required

- Phillips #1 screwdriver
- 6 foot ground wire with ring terminal ends (provided)

NOTE: Currently shipping DXLink Transmitters and Receivers provide a designated ground location on the rear of the chassis for attaching a ground wire. For instructions on attaching a ground wire to DXLink Modules without a designated ground location, see page 115.

Attaching a Ground Wire to a Common Earthed Ground

Connect the running end of the ground wire (fixed end attached to a DXLink Transmitter or Receiver) to a common earthed ground (ideally, referenced to the Enova DGX Switcher or Enova DVX Solution).

IMPORTANT: If one DXLink Transmitter or Receiver is grounded, any remaining ungrounded units that are connected to the same board on the Enova DGX Switcher must also be grounded.

Attaching Ground Wire to Module

IMPORTANT: Before attaching the ground wire to the chassis, ensure all connectors are clear.

To attach a ground wire to a module:

1. If powered, power down the DXLink Module.

2. Remove the designated ground screw and washer from the rear of the module.

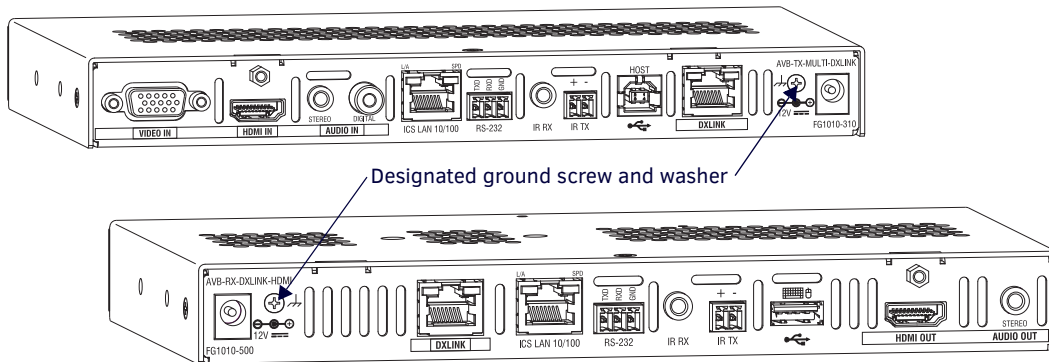

FIG. 22 Remove designated ground screw and washer

3. Secure the ring terminal of the ground wire against the chassis with the ground screw and washer.
4. Ensure the ground wire is positioned so that it does not interfere with any of the connectors.

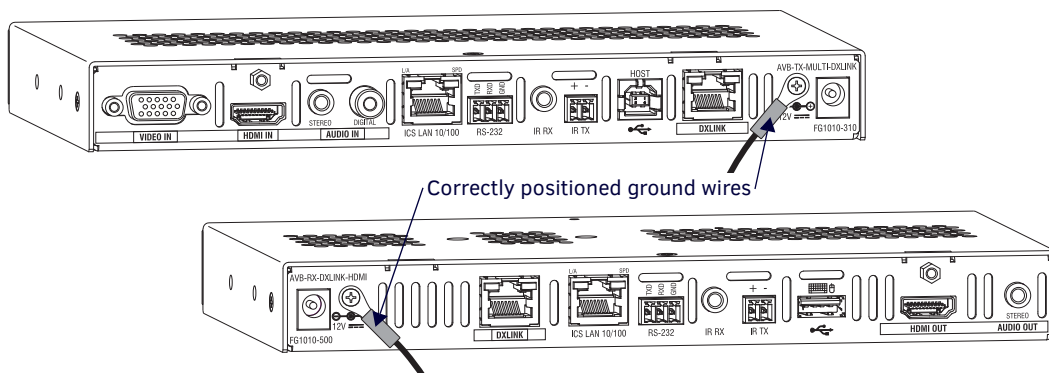

FIG. 23 Position ground wire away from connectors

5. Attach the ground wire to a common earthed ground (see “Attaching a Ground Wire to a Common Earthed Ground” on the previous page).
6. Continue the DXLink Module installation process (or reapply power to the module).

Attaching Ground Wire to Wallplate TX or Decor Wallplate TX

The Wallplate TX and Decor Wallplate TX each have a designated ground screw on the rear; look for the grounding symbol. If the DXLink Wallplate does not have a designated screw, use the screw directly above the DXLink (RJ-45) connector on the rear for grounding.

To attach a ground wire to a DXLink Wallplate or Decor Wallplate TX:

1. If powered, power down the unit by removing the DXLink cable from the rear.
2. Remove the ground screw and washer for the applicable unit, as indicated in FIG. 24.

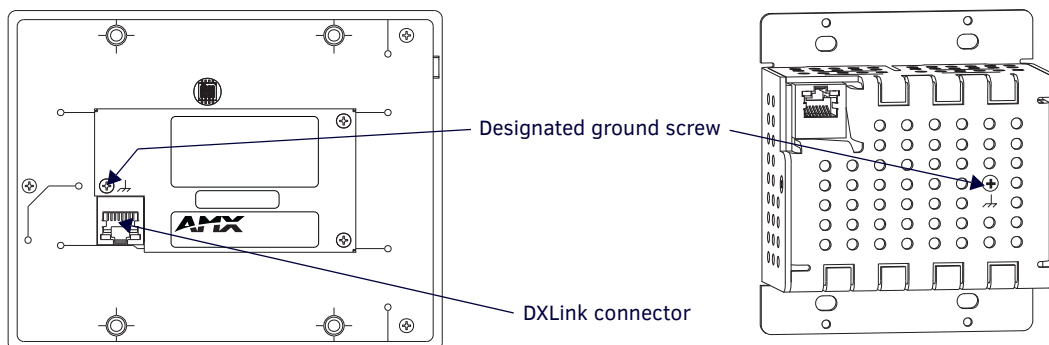

FIG. 24 Wallplate TX and Decor Wallplate TX - Remove ground screw and washer

3. Secure the ring terminal of the ground wire against the chassis with the ground screw and washer.

4. Ensure the ground wire is positioned so that it does not interfere with the DXLink connector.

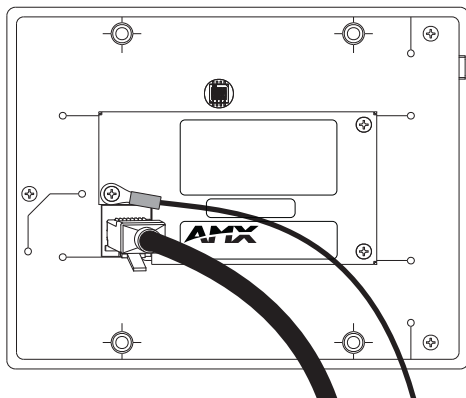

FIG. 25 Ground wire positioned so it does not interfere with DXLink connector (Wallplate TX shown)

5. Attach the ground wire to a common earthed ground (see page 37).
6. Continue the installation process (or reattach the DXLink cable from the Enova DGX Switcher to the DXLink unit).

Important Twisted Pair Cabling Requirements and Recommendations

The following requirements and recommendations apply to cabling DXLink (RJ-45) connectors:

- DXLink cable runs require shielded category cable (STP) of Cat6 (or better).
- DXLink twisted pair cable runs for DXLink equipment shall only be run within a common building.*
- DXLink delivers 10.2 Gb/s throughput over shielded category cable. Based on this bandwidth requirement, we recommend following industry standard practices designed for 10 Gigabit Ethernet when designing and installing the cable infrastructure.
- The cables should be no longer than necessary to reach the end-points. We recommend terminating the cable to the actual distance required rather than leaving any excess cable in a service loop.
- For complete cable specifications, see page 23.

For more details and helpful cabling information, reference the white paper titled “Cabling for Success with DXLink” available at www.amx.com or contact your AMX representative.

* “Common building” is defined as: Where the walls of the structure(s) are physically connected and the structure(s) share a single ground reference.

Twisted Pair Cable Pinouts

The pinout in FIG. 26 is for twisted pair cable that connects to the ICS LAN 10/100 connector or to the DXLink connector on the Transmitters and Receivers. Use either the T568A or T568B pinout specification for termination of the twisted pair cable used between the modules in a standalone setup or between Transmitters and Receivers and an enclosure in a full system.

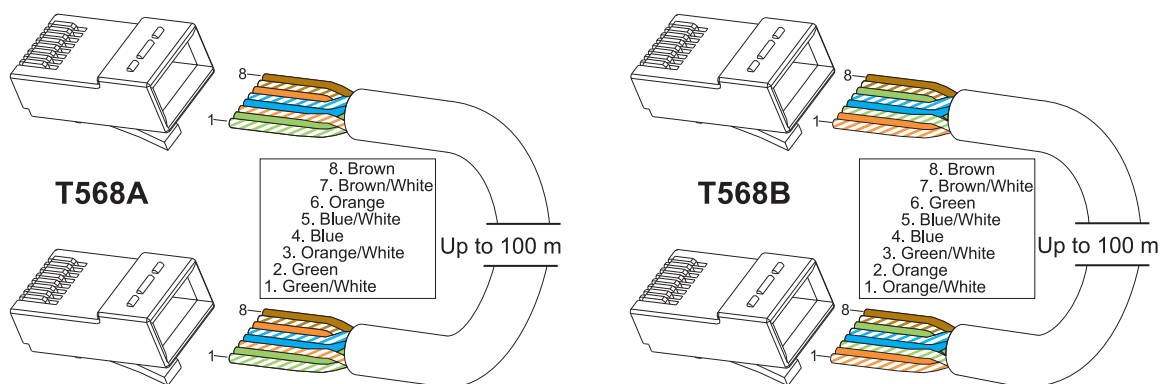

FIG. 26 Twisted pair cable pinouts for Ethernet connectors

In a typical installation, the cables should be stretched to their full length between Transmitters and Receivers and the enclosure or between modules in a standalone system. Service loops or coils of the cable may reduce the overall cable performance and should be minimized whenever possible.

RJ-45 LEDs

ICS LAN 10/100 Connector LEDs (modules only)

The following information applies to the LEDs on the ICS LAN 10/100 connector on the modules (FIG. 27). Note that #1 Toggle *must* be set to ON or ICS LAN functionality will not be provided.

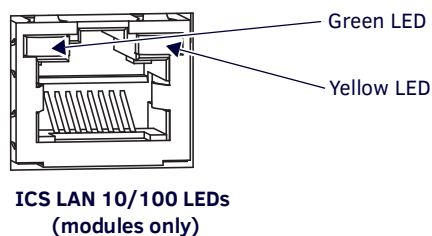

- Link/Activity (L/A) Green LED:
 - On – Link status is active (when the Ethernet cable is connected and terminated correctly)
 - Off – Link status is not active
- Speed Status (SPD) Yellow LED:
 - On – Speed status is 100 Mbps
 - Off – Speed status is 10 Mbps

FIG. 27 Module ICS LAN 10/100 connector LEDs

NetLink Connector LEDs (Wallplate TX/Decor Wallplate TX only)

The following information applies to the NetLink LEDs on the bottom edge of the Wallplate TX and on the front of the Decor Wallplate TX, which reflect NetLink communication and status via their DXLink lines (FIG. 28).

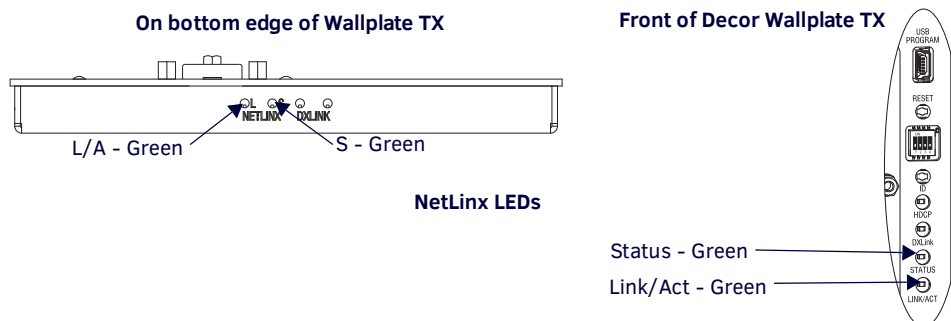

FIG. 28 Wallplate TX and Decor Wallplate TX NetLink LEDs

- **L/A or Link/Act Green LED** – Link/Activity LED indicates network communication activity.
- **S or Status Green Led** – The Status LED indicates unit status.

TIP: If the Wallplate TX is installed in a location where it is difficult to check the LEDs on the bottom edge, slide a white piece of paper or a small mirror under the edge to view LED status.

DXLink Connector LEDs

The following information applies to the LEDs located on the DXLink (RJ-45) connectors on the rear of all DXLink Transmitters and Receivers. It also applies to the DXLink LEDs on the bottom edge of the Wallplate TX and the DXLink LEDs on the front of the Decor Wallplate TX.

- Yellow:
 - On – Authenticated HDCP (handshaking has occurred successfully)
 - Flashing – Video active; no HDCP
 - Off – No Video
- Green:
 - On – DXLink connection established (Endpoint Mode between DX TX/RX and switcher; Extender Mode between TX and RX)
 - Off – DXLink connection not established

The LEDs in FIG. 29 provide information for the DXLink connector.

NOTE: If the RJ-45 connector is upside down compared to the one in FIG. 29, the yellow LED will be on the right and the green LED on the left.

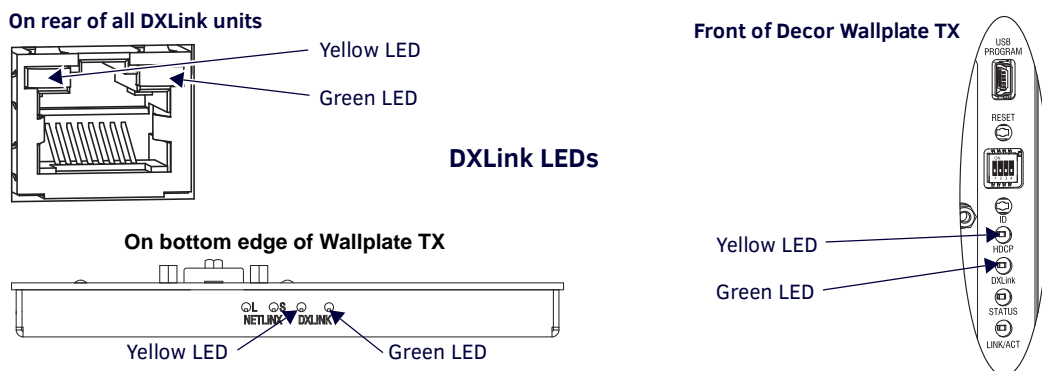

FIG. 29 DXLink (RJ-45) LED; Wallplate TX DXLink LEDs; Decor Wallplate TX DXLink LEDs

Audio Type Precedence

The connectors for bringing audio into the system on the Transmitters are as follows:

- HDMI In connector – Embedded audio signal
- Digital Audio In jack – Digital audio signal (S/PDIF); not available on the Wallplate TX and Decor Wallplate TX
- Stereo Audio In jack – Analog stereo audio signal

The hierarchy for audio type precedence* is listed in the following table for the Transmitters:

Audio Type Precedence on Transmitters	
Incoming Signal	Audio Type Selected
HDMI w/ embedded digital audio	HDMI w/ Embedded digital audio
S/PDIF digital audio only (not applicable for Wallplate TX and Decor Wallplate TX)	S/PDIF digital audio
Stereo audio only	Stereo audio
S/PDIF digital audio and stereo audio (not applicable for Wallplate TX and Decor Wallplate TX)	S/PDIF digital audio
HDMI w/ embedded digital audio and S/PDIF digital audio (not applicable for Wallplate TX and Decor Wallplate TX)	HDMI w/ Embedded digital audio
HDMI w/ embedded digital audio and stereo audio	HDMI w/ Embedded digital audio
HDMI w/ embedded digital audio, S/PDIF digital audio, and stereo audio (not applicable for Wallplate TX and Decor Wallplate TX)	HDMI w/ Embedded digital audio

* Audio precedence as specified in the table above is applicable when the AUDIN_FORMAT_AUTO command is set to ENABLE; this precedence can be overridden by SEND_COMMANDs (see page 72).

The audio selected by the Transmitters is embedded on the HDMI signal (if not already embedded) and sent to the switcher (or to DX-RX in a standalone pair) via the DXLink cable.

The DX-RX will take the embedded audio it receives from a Transmitter** and output the following types of audio:

- HDMI Out connector – Embedded digital audio signal
- Stereo Audio Out connector – Analog stereo audio signal

** These exceptions apply: In order for audio to be sent out of the analog stereo audio connector on the DX-RX, the audio *must* have originated or be embedded in the HDMI signal on the Enova DGX Digital Media Switcher, Enova DVX Solution, or Transmitter as a 2 channel signal (either analog stereo or 2 channel L-PCM). Multi-channel (>2 channel) L-PCM formats will pass incomplete audio (only 2 of the multiple channels will be sent). All other audio formats will be muted at the connector.

Wallplate Transmitters – Attaching Signal/Transport Cables

IMPORTANT: If network connection is required – before attaching cables, set DIP switch #3 Toggle.

IMPORTANT: Do not use the RJ-45 connector on rear for connecting to a standard Ethernet Network.

To attach signal and transport cables to a Wallplate TX or Decor Wallplate TX:

1. Install double-gang back box. (For Wallplate TX mounting options, see page 36. The Decor Wallplate TX uses a standard US double-gang back box).

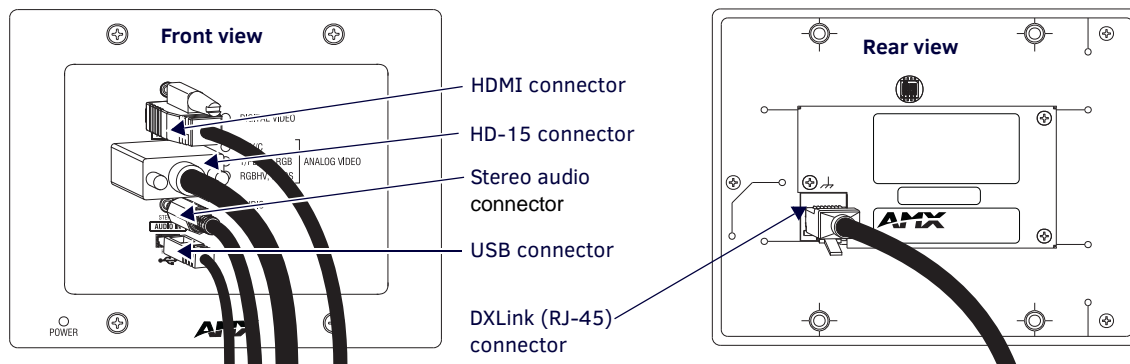

FIG. 30 Attach signal and transport cables (Wallplate TX shown)

Mount Unit, Set DIP switches, and Cable DXLink –

2. **Wallplate TX –**
 - a. Remove the four screws from the front that fasten it to the mounting bracket.
 - b. **Important** – If a network connection is required, set #3 Toggle to ON (see page 35).
 - c. Attach bracket (arrows inside point up) to double-gang back box per illustrations on page 36.
 - d. DXLink connector – Attach a twisted pair cable from the DXLink Input Board on the switcher through the mounting bracket to the DXLink (RJ-45) connector on the rear of the unit.

Decor Wallplate TX –

- a. DXLink connector – Attach a twisted pair cable from the DXLink Input Board on the switcher to the DXLink (RJ-45) connector on the rear of the unit.
- b. Attach unit to the back box with four screws through the large screw holes.

IMPORTANT: If a network connection is required, set #3 Toggle to ON (see page 35).

3. **Wallplate TX –** Reattach unit to the mounting bracket with the four screws removed in Step 2a.

Decor Wallplate TX –

- a. Check LEDs for normal display (see the table on the next page).
- b. Attach standard decor style front cover plate (customer provided) to the unit.

Cable front (note that connector arrangement differs between unit types) –

4. HDMI In connector – Attach the HDMI cable from the source device to the HDMI In connector.
5. Video In connector – Attach the HD-15 cable from the source device to the Video In connector (for VGA, component, S-Video, and composite pinouts, see page 105).
6. Stereo Audio In jack (optional) – Plug in the analog audio cable from the stereo audio source into the Stereo Audio In jack. For audio precedence information, see page 41.
7. If necessary, set the video and audio formats using SEND_COMMANDS (see page 64).
8. USB Host port (optional) – Attach USB cable from PC. The port's default is "enabled." For USB port information, see page 18. For USB SEND_COMMAND information, see page 77.
9. Check LEDs for normal display (see the table on the next page).

Additional Wallplate TX and Decor Wallplate TX Functionality

The following items are on the left edge of the Wallplate TX and on the front of the Decor Wallplate TX.

Reset Button

The Reset button resets the unit's CPU (acts like a power cycle soft reboot).

Program Port

This port (USB mini-B connector) supports DGX Configuration Software for programming a customer VGA EDID.

ID Pushbutton

The ID Pushbutton places the unit in ID Mode for setting the NetLink ID (device only) and provides additional functionality, such as placing the unit in Static IP Mode or DHCP Mode (see page 56).

Wallplate TX and Decor Wallplate TX – Indicator LEDs

The Wallplate TX and Decor Wallplate TX receive power from a switcher through the DXLink (RJ-45) connection to a DXLink Input Board in the switcher. They can also receive power via either PDXL-2 (FG1090-170) or PS-POE-AT-TC (FG423-84).

IMPORTANT: We recommend determining the power budget to maintain power redundancy for the system (see page 31).

TIP: If the Wallplate TX is installed in a location where it is difficult to check the LEDs on the bottom edge, slide a white piece of paper or a small mirror under the edge to view LED status.

Wallplate TX and Decor Wallplate TX Indicator LEDs		
LEDs	Normal Display	Indicates
Digital Video (default)	Green	The Wallplate TX and Decor Wallplate TX have been configured* to pass HDMI (for SEND_COMMAND information, see page 68)
Analog Video	One of the 3 LEDs will be Green	The Wallplate TX and Decor Wallplate TX have been configured* to pass one of the following types of analog video (for SEND_COMMAND information, see page 68): <ul style="list-style-type: none"> • C (composite) or Y/C (two component) • Y/PB/PR or RGB (three component) • RGBHV (five component) or RGBS (four component)
Audio	Green	The Wallplate TX and Decor Wallplate TX have been configured* to pass analog audio as the audio source being embedded on the DXLink output connection (coupled with either the analog or digital video input path); for SEND_COMMAND information, see page 72
Power	Green	Power (from switcher or DXLink power injector) is applied
LEDs (bottom edge of Wallplate TX)		
NetLink - L (Link)	Green	Active LAN connection to an AMX Network (Blinking = #3 Toggle OFF)
NetLink - S (Status)	Green Off	<ul style="list-style-type: none"> • Speed status is 100 Mbps • Speed status is 10 Mbps
DXLink Yellow	Yellow Flashing Off	<ul style="list-style-type: none"> • Authenticated HDCP (handshaking has occurred successfully) • Video is active; no HDCP • No Video
DXLink Green	Green	DXLink connection is established
LEDs (on front of Decor Wallplate TX)		
HDCP	Yellow Flashing Off	<ul style="list-style-type: none"> • Authenticated HDCP (handshaking has occurred successfully) • Video is active; no HDCP • No Video
DXLink	Green	DXLink connection is established
Status	Green Off	<ul style="list-style-type: none"> • Speed status is 100 Mbps • Speed status is 10 Mbps
Link/Act		Active LAN connection to an AMX Network (Blinking = #3 Toggle OFF)

* The LEDs for Digital Video, Analog Video, and Audio each indicate the configured state of the connectors, not necessarily the presence of signals through the Wallplate TX or Decor Wallplate TX.

IMPORTANT: If the indicator LEDs for the Wallplate TX or Decor Wallplate TX do not respond with a normal display as stated in the table above, check all of the connections and the suggestions in the "Troubleshooting" chapter (see page 83) before contacting technical support (see page 86).

DX-TX or HDMI TX – Attaching Signal, Transport, and Control Cables

IMPORTANT: Before attaching cables, be sure to set the DIP switch's toggles if necessary (see page 36).

IMPORTANT: Do not use the RJ-45 connector labeled “DXLink” for connecting to a standard Ethernet Network.

NOTE: Power, IR, and RS-232 ports are covered in their own sections.

To attach signal, transport, and control cables to DX-TX or HDMI TX:

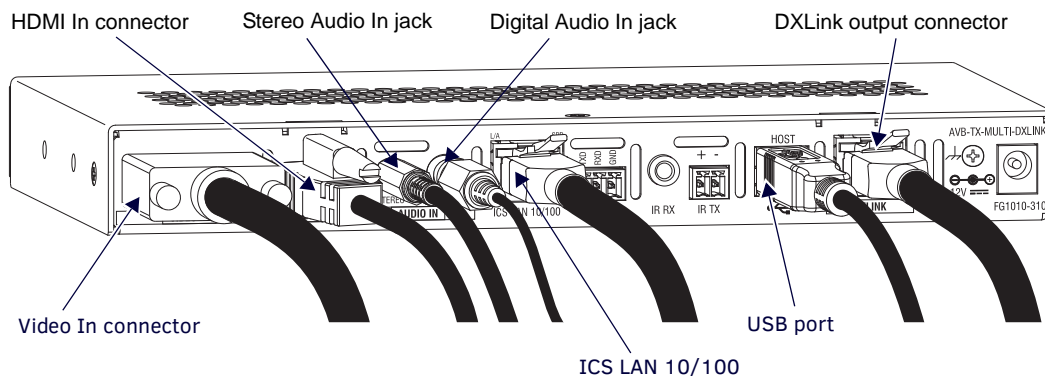

FIG. 31 Attach signal and control cables (DX-TX shown)

1. **DX-TX only** – Attach the HD-15 cable from the source device to the Video In connector (for pinouts for VGA, component, S-Video, and composite, see page 105).
2. HDMI In connector – Attach the HDMI cable from the source device to the HDMI In connector.*
3. DXLink connector – Attach a twisted pair cable to the DXLink connector for UTP transport to the switcher (or DX-RX).
4. Stereo Audio In jack (optional) – Plug in the analog audio cable from the stereo audio source into the Stereo Audio In jack. For audio precedence information, see page 41.
5. Digital Audio In jack (optional) – Insert the S/PDIF (RCA) plug on the digital audio cable from the digital audio source into the Digital Audio In jack. For audio precedence information, see page 41.
6. ICS LAN 10/100 connector (optional) – Attach a twisted pair cable from this connector to a LAN.
7. If necessary, set the video and audio formats using commands (for NetLinx programming information, see page 64).
8. USB Host port (optional) – Attach USB cable from PC. The port's default is “enabled.” For USB port information, see page 18. For USB SEND_COMMAND information, see page 77.

* DVI cable can be used instead (via a DVI-to-HDMI cable adapter); however, the advanced audio support from HDMI will not be available.

NOTE: The ID Pushbutton places the module in ID Mode for setting the NetLinx ID (device only) and provides additional functionality, such as placing the device in Static IP Mode or DHCP Mode. For complete information, see page 56.

DX-TX or HDMI TX – Applying Power

IMPORTANT: If desktop power is used to power the Transmitter, only the provided desktop power supply should be used and it must not be altered in any way. Remote power can only be provided via a switcher or a DXLink power injector. AMX does not support the use of any other power supplies or power injectors as these may potentially damage the DXLink equipment.

Important Power Considerations for Enova DGX Systems

- Local power – Local power (desktop power supply) always takes precedence over power via the DXLink line from the switcher. However, if a locally powered module is connected to a switcher and the local power is lost (i.e., unplugged or turned off), the module will power down and then automatically power back up using power from the switcher via the DXLink connection (increasing the overall power draw on the switcher). When local power is restored, it automatically replaces the power over the DXLink line.
- DXLink power – When modules are being powered by an Enova DGX DXLink board or DXLink power injector (using power via the DXLink line), to maintain the switcher's power redundancy, we recommend that you:
 - Determine the power budget based on the Input/Output boards used and the quantity of powered endpoints (modules); see page 31.
 - Do not use local DC power jack on module (even if local power adapter is turned off).

NOTE: When using DXLink Power from an Enova DGX Switcher, we recommend wiring a technical ground for the ungrounded sources/destinations with respect to the DXLink Transmitters/Receivers and switcher (see page 37).

The following instructions do not apply if you are using power from the switcher via the DXLink line in an Enova DGX system.

To apply power to the DX-TX or HDMI TX:

1. Plug the cord from the desktop power supply (provided) into the power jack on rear of the module (2.1 mm DC jack for 12 V local power).
2. Plug the desktop power supply into an AC external power source.

The Power LED on the front of the module turns a constant green, which indicates a ready state.

Some of the additional LEDs also turn a constant green. For normal LED display, see table below.

DX-TX and HDMI TX – Indicator LEDs

The LED indicators are listed in the table as they appear on the front of the module from left to right.

DX-TX and HDMI TX LEDs	Normal Display	Indicates
Power	Green	Power is applied to the Transmitter
Digital Video	Green	A digital signal is present through the Transmitter
Audio	Green	A digital audio signal is present through the Transmitter
Analog Video (DX-TX only)	One of the 3 LEDs is Green	Type of analog video present through the DX-TX: <ul style="list-style-type: none"> • C (composite) or Y/C (2 component) • Y/PB/PR or RGB (3 component) • RGBHV (5 component) or RGBS (4 component)
IR TX	Red	IR TX active communication
IR RX	Yellow	IR RX active communication
232 (Serial) TX	Red	Serial TX active communication
232 (Serial) RX	Yellow	Serial RX active communication
NetLinx Link/Act	Green	Active LAN connection to an AMX Network (Blinking = #3 Toggle OFF)
NetLinx Status	Green	LAN connection is active

DX-TX and HDMI TX – LED Troubleshooting

If indicator LEDs for modules do not respond with a normal display as stated in table above:

- Check all power connections.
- Check the “Detailed NetLinx (Link/Act and Status) LED Behavior” section on page 50.
- Try the suggestions in the “Troubleshooting” chapter (see page 83).

For information on restoring the module’s default settings on power up, see page 57.

DX-RX – Attaching Signal and Control Cables

IMPORTANT: Before attaching cables, be sure to set DIP switch’s toggles if necessary (see page 36).

IMPORTANT: Do not use the RJ-45 connector labeled “DXLink” for connecting to a standard Ethernet Network.

NOTE: Power, IR, and RS-232 ports are covered in their own sections.

To attach signal, transport, and control cables to the HDMI RX:

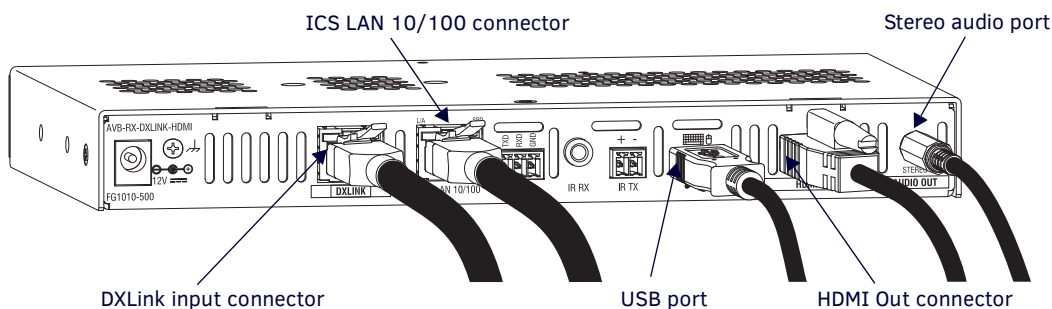

FIG. 32 Attach signal and control cables to HDMI RX

1. DXLink (input) connector – Attach a twisted pair cable from the switcher (or DX-TX or HDMI TX) to the DXLink connector on the DX-RX.
2. HDMI Out connector – Attach the HDMI cable that goes to the destination device.*

3. ICS LAN 10/100 connector (optional) – Attach a twisted pair cable from this connector to a LAN. (For NetLinX programming information, see page 64.)
4. USB port (optional) – Connect to a hub using a USB-A cable; connect keyboard and mouse to the hub. (This port is for sending keyboard / mouse commands to a PC.) For USB port information, see page 18. For USB SEND_COMMAND information, see page 77.
5. Stereo Audio Out connector (optional) – Plug the audio cable (that goes to the audio destination) into the stereo audio jack. For audio precedence information, see page 41. For information on audio SEND_COMMANDs (including enabling the analog audio format), see page 68.

* DVI cable can be used instead (via a DVI-to-HDMI cable adapter); however, the advanced audio support from HDMI will not be available.

NOTE: The ID Pushbutton places the DX-RX in ID Mode for setting the NetLinX ID (device only) and provides additional functionality, such as placing the device in Static IP Mode or DHCP Mode. For information, see page 56.

TIP: If scaling adjustments are necessary, use SEND_COMMANDs (see page 64). If connected to an Enova DGX output, use DGX Configuration Software via the switcher for scaling.

DX-RX – Applying Power

IMPORTANT: If desktop power is used to power the Receiver, only the provided desktop power supply should be used and it must not be altered in any way. Remote power can only be provided via the switcher, PDXL-2 (FG1090-170), or PS-POE-AT-TC (FG423-84).

IMPORTANT: The “Important Power Considerations for Enova DGX Systems” also apply to the DX-RX (see page 31).

To apply power to the DX-RX:

1. Plug the cord from the desktop power supply (provided) into the power jack on rear of the DX-RX (2.1 mm DC jack for 12 V local power).
2. Plug the desktop power supply into an AC external power source.

The Power LED on the front of the DX-RX illuminates a constant green, which indicates a ready state. Some of the additional LEDs will also turn a constant green. For normal LED display, see the table below.

IMPORTANT: If any Receivers are being powered through an Enova DGX, we recommend determining the power budget to maintain power redundancy for the system (see page 44).

DX-RX – Indicator LEDs

The LED indicators are listed in the table as they appear on the front of the RX from left to right.

DX-RX LED	Normal Display	Indicates
Power	Green	Power is applied to the Receiver
Video	Green	A video signal is present through the Receiver
Audio	Green	An embedded audio signal is present through the Receiver
Scaling: – Bypass – Auto – Manual	One LED is green The other two are off	Receiver is in one of the three modes for scaling <ul style="list-style-type: none"> • At initial power up, the Receiver defaults to the Auto scaling option* • Press the Scaling button to turn on the Bypass option or the Manual option
IR TX	Red	IR TX active communication
IR RX	Yellow	IR RX active communication
Serial TX	Red	Serial TX active communication
Serial RX	Yellow	Serial RX active communication
NetLinX Link/Act	Green	Active LAN connection to an AMX Network (Blinking = #3 Toggle OFF)
NetLinX Status	Green	LAN connection is active

* When the output cable is disconnected from the DX-RX or if no EDID can be found on the destination device, the last used Scaling Mode LED will be ON. In either case, the DX-RX will continue to hold its output resolution to the last known preferred resolution until a power cycle or reconnection of a sink with a valid EDID. On power up without a valid EDID, the default preferred output resolution presented will be 1280x1024,60Hz until a different EDID is detected.

DX-RX – LED Troubleshooting

If the indicator LEDs for the modules do not respond with a normal display as stated in the table above:

- Check all power connections.
- Check the “Detailed NetLinX (Link/Act and Status) LED Behavior” section on page 50.
- Try the suggestions in the “Troubleshooting” chapter (see page 83).

For information on restoring the module’s default settings on power up, see page 57.

Serial Data Transfer and IR Flow Control

The illustration in FIG. 33 shows the bidirectional serial data transfer and IR flow control when DXLink Modules are used in Endpoint Mode with an Enova Digital Media Switcher. The switcher has an integrated NetLinx Central Control Processor which provides native AMX control at each remote location fed by a DXLink Transmitter or Receiver. Control is sent over twisted pair cable (via the DXLink ports). This also holds true when Enova DVX Solutions are used.

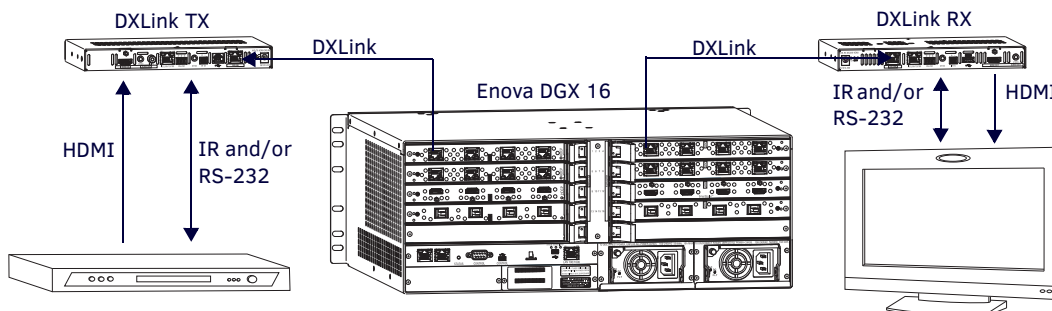

FIG. 33 Serial data transfer and IR flow control

Optional: DX-TX, HDMI TX, and DX-RX – Wiring for Serial Data Transfer

The RS-232 (serial) ports are the 3-position screw terminal blocks on the rear of the modules to the right of the ICS LAN 10/100 connector. Wire these ports to supply serial data along with the associated video and audio signals from a source device (over the twisted pair cable between the DX-TX or HDMI TX and the DX-RX) to a destination device or vice versa from the DX-RX to the DX-TX or HDMI TX. In addition to being directly connected to a device, this port can be connected as an independent native NetLinx control port from a networked NetLinx Central Controller.

IMPORTANT: For serial strings to pass through a standalone TX and RX pair (in Extender Mode) without a NetLinx Master acting as the host, DIP switch #2 Toggle must be set to OFF on each module.

The RS-232 port labels are relative to the data flow. On the DX-TX or HDMI TX, data enters the system at the RX label and leaves the system at the TX label on the Receiver (FIG. 34). The flow is reversed from the Receiver to the Transmitter.

NOTE: On both modules, the RS-232 connector pinout is “TX - RX - Ground.”

To wire the RS-232 (serial) connectors on the modules for data transfer:

1. Wire the RS-232 connectors on the modules according to the pinout directly above the connector.



FIG. 34 Wire RS-232 ports for serial data transfer

2. Use the command RXON to enable this port on the Transmitter and the Receiver. (For complete Serial SEND_COMMAND programming information, see page 76.)

Serial Control – Endpoint Mode and SEND_COMMANDS

In Endpoint Mode (modules are connected to a switcher), serial operations are handled by the host providing control of the endpoints. The Master’s programming specifies where the serial commands are sent (this is handled independently from the routing of the video signals). For additional information on Endpoint Mode, see page 28. For Serial SEND_COMMANDS, see page 76.

Optional: DX-TX, HDMI TX, and DX-RX – IR Control

For additional information on the IRO3 and CC-NIRC, which are required for IR control, see page 19. (The IRO3 and CC-NIRC are not included with the modules.) A compatible remote control unit can also be used with the system. In addition to being directly connected to a device, this port can be connected as an independent native NetLinX control port from a networked NetLinX Central Controller.

IMPORTANT: *When a Transmitter and Receiver are used as a standalone pair, the IR control will be passed through directly in Extender Mode when #2 Toggle is set to OFF (default). When #2 Toggle is set to ON, the Master handles the IR control. When a Transmitter and Receiver are connected to a switcher, they will default to Endpoint mode and the integrated Master handles the SEND_COMMANDs.*

The IR Receiver is connected to the IR RX port on the Transmitter, and the IR Emitter is connected to the IR TX port on the Receiver, or the connections can be reversed.

IRO3 External IR Receiver Module (not included)



FIG. 35 IR Receiver cable (FG-IR03)

To connect an IR Receiver to a module:

1. Connect the jack on the IRO3 External IR Receiver Module cable (FG-IR03) to the IR RX port on the module.
2. Run the cable and attach the IR receiver bud so that it has a clear line-of-sight with the intended remote control device.

CC-NIRC NetLinX IR Emitter Cable (not included)



FIG. 36 IR Emitter cable (FG10-000-11)

To connect an IR Emitter to a module:

1. Connect the Phoenix connector on the CC-NIRC NetLinX IR Emitter cable (FG10-000-11) to the IR TX port on the module.
2. Run the other end of the IR Emitter cable to the display device and locate the IR window.
3. Attach the IR Emitter bud over the device's IR sensor by removing the cover on the reverse side of the Emitter and sticking the bud directly over the IR window.

IMPORTANT: *For systems that include a switcher – when installation of the IR Receiver and IR Emitter is complete, load the appropriate driver (for instructions, see page 60) and program the IR remote according to the product's documentation.*

IR Control – Endpoint Mode and SEND_COMMANDs

In Endpoint Mode (modules are connected to a switcher), IR operations are handled by the host providing control of the endpoints. The Master's programming specifies where the IR commands are sent (this is handled independently from the routing of the video signals). For additional information on Endpoint Mode, see page 28. For IR SEND_COMMANDs, see page 73.

ID Pushbutton Functions

The ID Pushbutton is located on the right front of the modules, on the left edge of the Wallplate TX, and on the front of the Decor Wallplate TX.

The ID Pushbutton can be used to perform four types of initial configuration settings:

- Toggle between DHCP and static IP addressing
- Assign a device address
- Reset the factory default settings
- Restore the factory firmware image

The functions performed depend on when and for how long the ID Pushbutton is pressed and held. For complete ID Pushbutton information, see page 56.

NOTE: *ID Pushbutton functions can also be implemented using Telnet commands (see page 91).*

DX-RX Scaling Button and Scaling Modes

The Scaling button is located on the front of the Receiver Module. Pressing the Scaling button cycles the module through the three scaling options: Bypass, Auto, and Manual.

- Bypass Mode – allows the video signal to display over the destination device without altering the signal's resolution.
- Auto Mode (default) – allows the destination device to choose the resolution it needs (this mode is AMX's SmartScale® Technology in action).
- Manual Mode – allows the user to configure the resolution that the video will display through a destination device.

Selecting a Scaling Mode results in the module maintaining or altering the source device's resolution as it is passed along to the destination device.

The Scaling Mode can be set on the DX-RX with the Scaling button (see instructions below), with DGX Configuration Software, or with SEND_COMMANDs (see page 66).

To set the scaling option (mode):

1. Press the Scaling button on the DX-RX once or twice until the LED for the desired scaling option illuminates solid green.

Bypass Mode

Bypass Mode allows the video signal to display over the destination device without altering the signal's resolution.

NOTE: *Interlaced and progressive video are supported into the Transmitters; progressive is only supported out of the Receiver unless it is in the Bypass mode, which is non-scaling.*

Auto Mode

At initial power up, the DX-RX defaults to the Auto scaling option.

NOTE: *When the output cable is disconnected from the DX-RX or if no EDID can be found on the destination device, the last used Scaling Mode LED will be ON. In either case, the DX-RX will continue to hold its output resolution to the last known preferred resolution until a power cycle or reconnection of a sink with a valid EDID. On power up without a valid EDID, the default preferred output resolution presented will be 1280x1024,60Hz until a different EDID is detected.*

Manual Mode

Manual Mode allows the user to configure the resolution that the video will display through a destination device. Manual Mode defaults to 1280x1024p,60Hz. This default resolution can be changed in two ways:

- Use the SEND_COMMAND VIDOUT_RES_REF to set the resolution and refresh rate (for details, see page 66).
- When used as a direct output of an Enova DGX DXLink Output Board, use DGX Configuration Software to set and persist the Manual scaling resolution for the connector on the DXLink Output Board; the DXLink Output Board sends the scaling resolution data to the DX-RX.

NOTE: *The scaling mode (and the aspect ratio) can also be set on the DXLink Output Board using DGX Configuration Software. The data is persisted on the board and sent to the DX-RX.*

Persistence of Scaling Options

The DX-RX defaults to "Auto" when power is cycled. The scaling option can be persisted using one of the following methods:

- Using the SEND_COMMAND: PERSISTAV (for details, see page 79).
- Using DGX Configuration Software to set and persist the scaling option for the connector on the DXLink Output Board on the Enova DGX Digital Media Switcher; the DXLink Output Board sends the scaling option data to the DX-RX.

Detailed NetLinx (Link/Act and Status) LED Behavior

The tables below provide detailed descriptions of all blink patterns for the NetLinx Link/Act and Status LEDs on the front of the Transmitter and Receiver Modules.

NOTE: The term "light show" refers to the back-and-forth scanning pattern of the LEDs associated with the LEDs on the modules.

Module Operational State as Indicated by LEDs

To determine the operational state (normal boot) of a module by its LEDs, check both the Link/Act and Status LED columns.

NetLinx LED Behavior and Operational States		
Link/Act LED	Status LED	Module Operational State
ON if connected to a system with an integrated Master. Blink OFF with data.	Follow Master's instruction for Blink Message if online with Master, otherwise ON.	Normal Online with Master (rest)
OFF	ON	Normal Boot (DHCP found) NOTE: This state continues from the time an IP address is obtained until the device is online with the Master.
Fast blink, then normal operation.	ON	Normal Boot (DHCP, no server) NOTE: This state continues until a valid IP address is obtained.
OFF during light show, then normal operation (OFF until connected to Master).	Fast blink (continues only during light show), then ON until first blink from Master.	Normal Boot (Static IP) NOTE: This state continues until the device finishes its light show.

ID Pushbutton Boot State and LED Behavior

To monitor the ID Pushbutton boot state of a module by its LEDs, check both the Link/Act and Status LED columns.

ID Pushbutton Boot and NetLinx LED Behavior		
ID Pushbutton Boot States	Link/Act LED	Status LED
Boot with ID Pushbutton held down.	Slow blink (1 Hz)	Slow blink (1 Hz)
ID Pushbutton held down long enough for reset to default parameters.	Fast blink until ID Pushbutton is released, then OFF	Fast blink until ID Pushbutton is released, then OFF
ID Pushbutton held down long enough for reset to default firmware image.	Solid ON, transitions to OFF once the unit completes writing to flash and is ready to reboot.	Solid ON, transitions to OFF once the unit completes writing to flash and is ready to reboot.
In Auto ID mode.	Normal	Blink (2 Hz)
ID Pushbutton held down long enough to accept new ID.	2 blinks, then normal	2 blinks, then normal
After boot: ID Pushbutton held down, but not long enough for IP mode change.	Slow blink (1 Hz)	Slow blink (1 Hz)
After boot: ID Pushbutton held down long enough for IP mode change.	Fast blink, then OFF	Fast blink, then OFF

Downloading Firmware State and LED Behavior

To monitor the state of a module by its LEDs when downloading firmware, check both the Link/Act and Status LED columns.

NetLinx LED Behavior when Downloading Firmware		
Downloading Firmware	Link/Act LED	Status LED
Downloading firmware to flash due to an upgrade via NetLinx Studio.	Fast blink, alternating with Status LED	Fast blink, alternating with Link/Act LED

DXLink TX/RX in a Multiple-Stage Switching System

When switching systems with DXLink Technology support (e.g., an Enova DGX Digital Media Switcher and an Enova DVX-3155HD) are connected via their DXLink ports, DXLink Transmitters and Receivers can be used to extend the video and audio transport.

IMPORTANT: *This section does not refer to the linking of enclosures from CPU to CPU, which is not supported in the Enova DGX Digital Media Switcher or the Enova DVX Solutions.*

In an installation with DXLink equipment in a multiple-stage switching system, the following apply:

- Network loops *must* be avoided (see page 33). The DXLink line's Ethernet functionality is disabled between the enclosures; therefore, no IR, serial, or Ethernet communication can be passed between them.
- When two switching systems with DXLink support are connected via their DXLink ports, only video and audio will be passed through the DXLink connection.
- When a DXLink input or output on one switching system determines that it is connected to a DXLink input or output on another switching system, the DXLink port will automatically disable all Ethernet, power, and control on that connection port so that the only things passed down the DXLink line are the video and audio signals.
- When connecting switching systems via DXLink ports, AMX recommends no more than three switcher throughputs (see the "Example" below).

Example

This example shows how DXLink Transmitters and Receivers can be used in a system where switchers are connected via their DXLink ports.

The signal path through three switchers could be: source device → **DXLink Transmitter** → [Enova DVX-3155HD](#), DXLink input (out a DXLink output) → [Enova DGX 32](#), DXLink input (out a DXLink output) → [Enova DGX 16](#), DXLink input (out a DXLink output) → **DXLink Receiver** → display device as an HDMI signal.

Network Configuration

Overview

IMPORTANT: If the TXs/RXs are connected to an Enova DGX 100 Series Switcher using auto-setup, see the “Hardware Reference Manual – Enova DGX 100 Series Digital Media Switchers” for network configuration information.

NOTE: If a DXLink module or wallplate has been configured for auto-setup mode and then auto-setup mode has been disabled, the unit may take longer to appear in NetLinx Studio than expected (1-2 minutes).

DXLink Modules support two IP Addressing Modes: Static IP and DHCP (with link-local fallback*).

To avoid having a large system consume numerous IP addresses, the Transmitter and Receiver default to disabling the network connection functionality. Therefore, the #3 Toggle must be set to ON before the Transmitter or Receiver can establish a network connection (see page 35).

When #3 Toggle is ON, the DXLink Modules are automatically placed in DHCP Mode, but they can be configured for either of the IP Addressing Modes via two methods:

- The front-panel ID Pushbutton (see page 56)
- Telnet commands (see page 91)

* “Link-local fallback” is a method by which an IP host, as a fallback from DHCP, can derive a local network-unique IP address by negotiating with the other IP hosts on the same network. Link-local can also be used in its own right as the primary method of IP address allocation. For details, see “DHCP Mode” below.

Static IP Mode – Default Parameters

IMPORTANT: Static IP Mode will not function until the #3 Toggle on the DIP switch is set to ON (see page 35). The #3 Toggle must be ON before the device is accessible via SEND_COMMANDS.

Default Parameters for Static IP Mode	
Address	192.168.1.2
Netmask	255.255.255.0
Gateway	192.168.1.1
DNS1	192.168.1.1
DNS2	192.168.1.1
DNS3	192.168.1.1

DHCP Mode

IMPORTANT: DHCP Mode will not function until the #3 Toggle on the DIP switch is set to ON (see page 35). The #3 Toggle must be ON before the device is accessible via SEND_COMMANDS.

DHCP Mode requires a connection to a network with a DHCP server located on it. This connection can be either indirect or direct.

- **Indirect connection** – In the case of an Enova DGX Digital Media Switcher or an Enova DVX Solution (Endpoint Mode) that is connected to a DHCP server device, the DHCP connection can be propagated through the system’s DXLink layer. First you must complete the following:
 - Set the #3 Toggle to ON to enable the network connectivity.
- **Direct connection** – In the case of a standalone pair (Extender Mode), to place the DXLink Modules in DHCP Mode you must complete the following:
 - Set the #1 Toggle to ON to enable access to the physical ICS LAN 10/100 port.
 - Set the #3 Toggle to ON to enable network connectivity (DHCP).
 - Connect the ICS LAN 10/100 port to a network where a DHCP server is located.

When in DHCP Mode (default setting), the module will attempt to get a DHCP lease (consisting of IP address, gateway, and other network parameters). Should the attempt fail, the module will then configure itself for a link-local address.

- DXLink Modules utilize a modified link-local addressing procedure. The first address to be tried is a known address in the link-local space: 169.254.2.2. That address will be probed, and if unclaimed will be used by the DXLink Module.
- If 169.254.2.2 is already claimed, the DXLink Module will choose a random address within the 169.254.x.x link-local address space (again probing to ensure that it is unclaimed).

Once the module is operating with a link-local address, it will periodically re-try DHCP and re-assign the IP to a valid DHCP grant if successful.

At any time, if the module determines that its IP address has changed, it will disconnect from the Master (if necessary, depending on the connection state) and then reconnect to the Master.

TCP/IP Address Configuration

DXLink Modules support IPV4 network addresses, gateway addresses, DNS server addresses, and network names. They also support NDP (NetLinx Discovery Protocol) capabilities as well as IP discovery via NetLinx Studio.

NOTE: NDP is a device discovery method used by NetLinx Masters. With NDP Beacon enabled, the Master will transmit NDP Beacons for AMX's proprietary device discovery.

Telnet IP Configuration Commands

The SET IP and GET IP Telnet commands listed in the tables in Appendix B (which start on page 92) can be sent directly to the device via a Telnet terminal session. These commands can be used for initial network configuration of the DXLink Modules.

- The default Telnet port is 23.
- Telnet is enabled by default.
- A value of 0 disables the telnet server.*

For details, see "Appendix B – Telnet (Terminal) Commands" on page 91. The appendix also includes a section on "Master Connection Modes" on page 98.

* If you set the Telnet port to "0" to disable it, you will need to perform a factory reset using the ID Pushbutton to re-enable it (see page 57).

External Master Versions

If the DXLink Module is bound to an external Master, we recommend using the versions listed in the table below, which can be found on the product's page at www.amx.com.

External Master Versions	
Master	Minimum Version
NX x200	v1.3.106
NI-x00/64 NI-x100 NI-x101	v4.1.404
Enova DGX 100 Series (NX Master)	v1.3.106
Enova DGX 8/16/32/64 (NX Master)	v1.3.106
Enova DGX 8/16/32 (NI Master)	v4.2.395
Enova DVX Product Line	v4.8.316
Enova DVX-2100HD (only)	v4.1.404

Offline Recovery Mechanism for DXLink Devices

Offline Recovery Mechanism – A new, optional, recovery mechanism for DXLink devices in the rare occurrence that these devices move from online to offline status for an extended period of time.

The default setting for the recovery mechanism is OFF, but may be enabled for environments where the DXLink device could lose connectivity to the Master for 5 minutes or longer.

IMPORTANT: *A reboot is required after setting the recovery mechanism before the new setting takes effect.*

The following Telnet Commands enable, disable, and query the Offline Recovery Mechanism:

- Set recovery mechanism to ON: WD ON
- Set recovery mechanism to OFF: WD OFF
- Query recovery mechanism's current status: WD

Once the device's recovery mechanism is set to the ON state via Telnet, the recovery mechanism monitors the ICSP connection to the Master. The recovery mechanism is not armed until the DXLink device is brought online. Entering an offline state triggers an internal timer in the DXLink device which, after 5 continuous minutes in the offline state, in turn triggers the recovery mechanism to issue a full reboot command to the DXLink device. During this time the DXLink device will reboot and all functions (including video and audio delivery) will be disabled while the reboot occurs. This process takes up to 45 seconds to complete.

This functionality is an option intended to be a safety net for the rare occasions when a device falls offline and remains there for a long enough period of time that the likelihood of the device coming back online on its own diminishes. The reboot is intended to restart the device and allow it another opportunity to connect with the Master it is bound to.

- Usage considerations include:
 - Once a device reboots, the recovery mechanism will not become armed again until the device reaches an online state with a Master.
 - Because video is lost during the reboot process, consideration should be given to certain installation designs where a Master or the network connection between the Master and a DXLink endpoint might regularly be disabled or turned off, but video might continue to flow through the DXLink device. In these environments, we recommend not enabling the Offline Recovery Mechanism.
- Additional capabilities of recovery mechanism – Although highly unlikely, the recovery mechanism also monitors the following states and provides a self-recovery mechanism if these states are ever encountered.
 - If a DXLink device processor enters an unstable processing condition
 - If the DXLink device's allowable minimum memory threshold is exceeded

Factory Default Parameters

Factory Default Parameters	
Parameter	Value
MAC Address	As set in factory
Serial Number	As set in factory
Ethernet Mode	Auto (i.e., speed, duplex, both, auto)
IP Addressing Mode	DHCP
IP Address (for static mode)	192.168.1.2
Netmask (for static mode)	255.255.255.0
Gateway (for static mode)	192.168.1.1
DNS1 (for static mode)	192.168.1.1
DNS2 (for static mode)	192.168.1.1
DNS3 (for static mode)	192.168.1.1
DNS Domain	amx.com
Hostname	Model (e.g., DX-RX); after factory reset, model with last 7 digits of serial #
Master Connection Mode	NDP - For details, see page 20.
Master URL (for TCP and UDP URL modes)	"" (blank)
Master Connection Port Number (for TCP and UDP URL modes)	1319
Friendly-Name	"" (blank) NOTE: <i>If the Friendly Name is non-blank, both Friendly Name and Location are concatenated to make NDPSTRING2, otherwise NDPSTRING2 is generated from the unit's serial number.</i>
Location	"" (blank)
Stored MAC Address of Master (for NDP binding)	00:00:00:00:00:00
ICSP Device Number	0 (0 = receive dynamic device number from Master)
System Number	0
Telnet Port	23 A value of 0 disables the Telnet server. Telnet is enabled by default.
SET BAUD	9600, N, 8, 1
CTOF Time	5 (0.5 seconds)
CTON Time	5 (0.5 seconds)
Receivers Only	
VIDOUT_ASPECT_RATIO	STRETCH
VIDOUT_RES_REF	1280x1024,60 (for Manual Mode)
AUDOUT_FORMAT	All
Transmitters Only	
VIDIN_AUTO_SELECT	ENABLE
VIDIN_FORMAT	HDMI (on Port 7), VGA (on Port 8)
VIDIN_RES_REF	1280x1024,60
VIDIN_PREF_EDID	1920x1080p,60
VIDIN_EDID	MIRROR OUT 1 (on Port 7), ALL RESOLUTIONS (on Port 8)
VIDIN_HDCP	ENABLE
VIDIN_VSHIFT	0
VIDIN_HSHIFT	0
VIDIN_PHASE	0
AUDIN_FORMAT_AUTO	ENABLE
AUDIN_FORMAT	Analog

Device IDs

Device IDs		
Model	ID (16-bits) Bound	ID (16-bits) Unbound
Multi-Format TX Module (DX-TX)	0x017F	0x014B
HDMI-TX Module (AVB-TX-HDMI-DXLINK)	0x017C	0x014B
Multi-Format Wallplate TX (DX-TX-WP)	0x017E	0x014B
Decor Wallplate TX (DX-TX-DWP)	0x018B	—
HDMI-RX Module (DX-RX)	0x017D	0x014B

Using the ID Pushbutton

The ID Pushbutton is located on the right front of the modules, on the left edge of the Wallplate TX, and on the front of the Decor Wallplate TX.

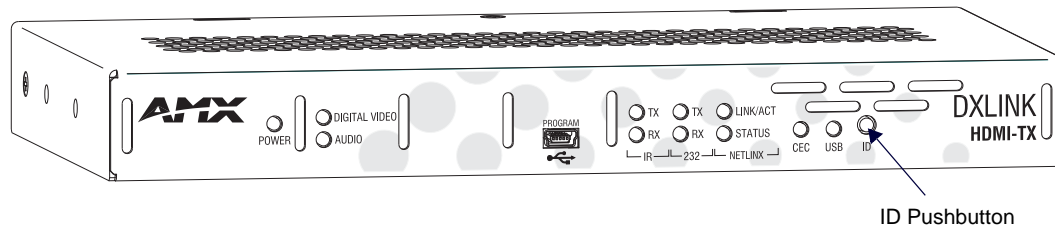

FIG. 37 ID Pushbutton on module (HDMI TX shown)

The ID Pushbutton can be used to perform four types of initial configuration settings:

- Toggle between DHCP and static IP addressing (see below)
- Assign a device address (page 57)
- Reset the unit to its factory default settings, which affects the parameters but not the firmware version (see page 57)
- Restore the unit to its factory firmware image, which affects both the firmware version and the parameters (see page 58)

The functions performed depend on when and for how long the ID Pushbutton is pressed and held. ID Pushbutton functions can also be implemented using Telnet commands (see page 91).

TIP: To monitor the ID Pushbutton boot state of a module by its NetLinx LED behavior, see page 59.

Toggling Between IP Addressing Modes: DHCP and Static IP

DXLink Transmitters and Receivers support both DHCP and static IP addresses. When the #3 Toggle is ON (see page 35), the modules automatically use DHCP with link-local fallback. However, you can use a static IP address which can be set via a Telnet command (`SET IP`), or you can use the factory default static IP address. The default static IP address can be recalled at any time by resetting the unit to its factory default configuration (see page 57). The default dynamic (DHCP) address is 169.254.2.2.

The ID Pushbutton can be used to toggle between the DHCP and Static IP Modes.

To toggle between DHCP and Static IP Modes:

1. Once the module has booted up, press and hold the ID Pushbutton until the Control/NetLinx LEDs toggle back and forth in unison approximately 10 times.
2. Release when it starts to blink faster.
 - When the Pushbutton is released, the module toggles either from static to dynamic (DHCP) IP addressing or vice versa and remains in that mode until the ID Pushbutton is used to set it again or a factory reset is performed.
 - The module automatically reboots to complete the process.

Assign a Device Address (ID Mode)

The ID Pushbutton can be used in conjunction with the ID (Identify) Mode feature in NetLinx Studio. A momentary press of the ID Pushbutton assigns a device address to the Transmitter or Receiver (which *must* be bound to the Master). The device *must* first be placed in ID Mode in NetLinx Studio or the momentary press will be ignored.

NOTE: The latest version of NetLinx Studio is available to download and install from www.amx.com. Refer to the NetLinx Studio online help for instructions on using the application.

To set the device address on a Transmitter or Receiver:

1. Check to be sure #3 Toggle on the bottom of the Transmitter or Receiver is set to ON.
2. In NetLinx Studio's OnLine Tree, select the Master to which the Transmitter or Receiver is bound.
3. From the Diagnostic menu, select Device Addressing.

The Device Addressing dialog box opens.

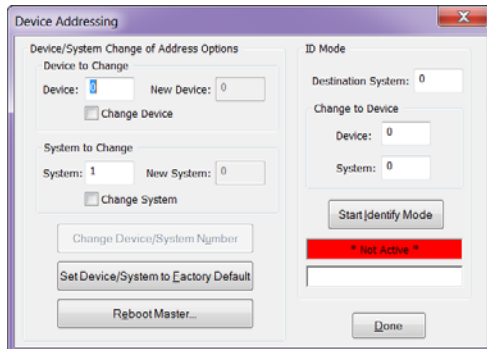

4. In the ID Mode section, enter the Device and System numbers that you want assigned to the device in the appropriate text boxes.
5. Click Start Identify Mode to place the named system in ID Mode.
The button changes to "Cancel Identify Mode" (click to cancel ID Mode).
The text box below the button displays a "Waiting...Press Cancel to Quit" message.

NOTE: When in ID Mode, the entire system is put on hold while it waits for an event from any NetLinx device in the named system (e.g., pressing the ID Pushbutton on the Receiver). The device that generates the first event is the device that will be "identified."

6. Briefly press and release the ID Pushbutton on the Transmitter or Receiver.
The Transmitter or Receiver will exhibit the following behavior:
 - Respond with an ID Mode address response.
 - Report its old address offline.
 - Report its new address online.

The OnLine Tree will refresh to display the new device address for the Transmitter or Receiver.

NOTE: NetLinx Studio (v4.0 or later) provides the ability to auto-increment IP Addresses and Hostnames as well as Device and System Numbers. Refer to the NetLinx Studio online help for details.

Reset the Factory Default Settings

During power up – if the ID Pushbutton is held until the Control/NetLinx LEDs toggle back and forth in unison approximately 10 times, then released when the faster blinking starts, the Transmitter or Receiver will reset to its factory default settings, which affect the parameters but not the firmware version.

Factory Parameters*

- Default static IP address of 192.168.1.2
- Default dynamic (DHCP) address of 169.254.2.2
- Default device number of 0
- NDP mode (see page 98)
- Unbound state
- No IRL files

* For a complete list of factory parameters, see the table on page 55.

Instructions for the modules are given first followed by the instructions for the Wallplate TX and the Decor Wallplate TX, which receive power over DXLink from the switcher.

IMPORTANT: If a Transmitter or Receiver Module is receiving power from a switcher, disconnect the DXLink connector on the module and reattach to apply power.

To reset a Transmitter or Receiver Module to its factory default settings:

1. Press and hold the ID Pushbutton while plugging in the power connector. Start counting when the NetLinX LEDs begin to flash in unison, not when the power connector is inserted.
 - Once the Transmitter or Receiver Module has started booting up, both NetLinX LEDs flash in unison at the rate of once per second.
 - After 10 flashes at that rate, the LEDs will blink in unison at a faster rate.

NOTE: A press-and-hold of the ID Pushbutton at power up will prevent the Transmitter or Receiver from attempting to come online until the ID Pushbutton is released. The Transmitter or Receiver will only attempt to come online if you release the Pushbutton prior to the faster blink rate.

2. At the point that the blink rate increases, release the ID Pushbutton.
The Transmitter or Receiver will automatically reboot to complete the process.

To reset Wallplate TX or Decor Wallplate TX to its factory default settings:

1. The ID Pushbutton and the Reset button are located on the left edge of the Wallplate TX and on the front of the Decor Wallplate TX.
2. Press and hold the ID Pushbutton. While the ID Pushbutton is down, press and release the Reset button. Start counting when the NetLinX LEDs begin to flash in unison, not when the Reset button is released.
 - Once the unit has started booting up, both NetLinX LEDs (on bottom edge) flash in unison at the rate of once per second.
 - After 10 flashes at that rate, the LEDs will blink in unison at a faster rate.

NOTE: A press-and-hold of the ID Pushbutton at boot will prevent the unit from attempting to come online until the ID Pushbutton is released. The unit will only attempt to come online if you release the Pushbutton prior to the faster blink rate.

3. At the point that the blink rate increases, release the ID Pushbutton.
The unit will automatically reboot to complete the process.

TIP: In the following two procedures – if you start a press and hold sequence with the ID Pushbutton and then decide not to change the settings, before you release the ID Pushbutton remove power from the unit to abort the procedure (remember, power can be applied via the external power supply or over DXLink, so one or both sources of power may need to be removed).

Restore the Factory Firmware Image and Factory Default Parameters

During power up – if the ID Pushbutton is held until the Control/NetLinX LEDs toggle back and forth in unison approximately 30 times (10 slow, 20 fast) and then released when they go solid, the module's factory firmware image will be restored. This procedure affects both the firmware version and the parameters.

Instructions for the modules are given first followed by the instructions for the Wallplate TX and the Decor Wallplate TX, which receive power over DXLink from the switcher, PDXL-2 (FG1090-170), or PS-POE-AT-TC (FG423-84).

IMPORTANT: If a Transmitter or Receiver Module is receiving power from a switcher, on the module disconnect the RJ-45 cable from the DXLink connector before starting the instructions below.

To restore the Transmitter or Receiver Module to its factory default firmware image:

1. Press and hold the ID Pushbutton while plugging in the power connector (if the power source is a switcher, plug in the RJ-45 connector into the DXLink port instead). Start counting when the NetLinX LEDs begin to flash in unison, not when the power connector is inserted.
 - After the LEDs complete the following sequence, release the ID Pushbutton:
 - Once the Transmitter or Receiver has started booting up, all LEDs flash in unison at the rate of once per second.
 - After 10 flashes at that rate, the LEDs will blink in unison at a faster rate.
 - After 10 seconds of flashing at the increased rate, all LEDs go to solid on.
2. Upon release of the ID Pushbutton, the Transmitter or Receiver executes the following actions:
 - a. Restores itself to its factory firmware image.
 - b. Resets to factory default parameters*:
 - Deletes all IRL files stored on the device.
 - Resets to the default static IP address of 192.168.1.2 and default DHCP address of 169.254.2.2.
 - Resets to the default device number of 0 (when bound to a Master, receives a dynamic device number from the Master).
 - Resets to NDP mode and being unbound.
3. Once all actions in Step 3 are completed, the LEDs all turn off, indicating the Transmitter or Receiver is ready to reboot.
The Transmitter or Receiver automatically reboots to complete the process.

* For a complete list of factory parameters, see the table on page 55.

To restore Wallplate TX or Decor Wallplate TX to its factory default firmware image:

NOTE: ID Pushbutton and the Reset button are located on the left edge of the Wallplate TX and on the front of the Decor Wallplate TX.

1. Press and hold the ID Pushbutton. While the ID Pushbutton is down, press and release the Reset button. Start counting when the NetLinx LEDs begin to flash in unison, not when the Reset button is released.
 - After the LEDs complete the following sequence, release both buttons:
 - Once the unit has started booting up, all LEDs flash in unison at the rate of once per second.
 - After 10 flashes at that rate, the LEDs will blink in unison at a faster rate.
 - After 10 seconds of flashing at the increased rate, all LEDs go to solid on.
 2. Upon release, the unit executes the following actions:
 - a. Restores itself to its factory firmware image.
 - b. Resets to factory default parameters*:
 - Deletes all IRL files stored on the device.
 - Resets to the default static IP address of 192.168.1.2 and default DHCP address of 169.254.2.2.
 - Resets to the default device number of 0 (when bound to a Master, receives a dynamic device number from the Master).
 - Resets to NDP mode and being unbound.
- * For a complete list of factory parameters, see the table on page 55.
3. Once all actions in Step 3 are completed, the LEDs all turn off, indicating the unit is ready to reboot. The unit automatically reboots to complete the process.

TIP: To monitor the ID Pushbutton boot state of a module, see the “ID Pushbutton Boot and NetLinx LED Behavior” table below.

ID Pushbutton Boot State and LED Behavior

To monitor the ID Pushbutton boot state of a module by its LEDs, check both the Link/Act and Status LED columns.

ID Pushbutton Boot and NetLinx LED Behavior		
ID Pushbutton Boot States	Link/Act LED	Status LED
Boot with ID Pushbutton held down	Slow blink (1 Hz)	Slow blink (1 Hz)
ID Pushbutton held down long enough for reset to default parameters	Fast blink until ID Pushbutton is released, then OFF	Fast blink until ID Pushbutton is released, then OFF
ID Pushbutton held down long enough for reset to default firmware image	Solid ON, transitions to OFF once the unit completes writing to flash and is ready to reboot	Solid ON, transitions to OFF once the unit completes writing to flash and is ready to reboot
In Auto ID mode	Normal	Blink (2 Hz)
ID Pushbutton held down long enough to accept new ID	2 blinks, then normal	2 blinks, then normal
After boot: ID Pushbutton held down, but not long enough for IP mode change	Slow blink (1 Hz)	Slow blink (1 Hz)
After boot: ID Pushbutton held down long enough for IP mode change	Fast blink, then OFF	Fast blink, then OFF

IRL File Transfers

Overview

The NetLinX Studio software application (available for free download from www.amx.com) provides the ability to transfer IR Library files to NetLinX devices such as DXLink Transmitters and Receivers.

When a Transmitter and/or a Receiver are being used in conjunction with a switcher, the switcher's integrated Master is used for the IRL file transfer. FIG. 38 shows a Transmitter and a Receiver bound to the integrated Master in an Enova DGX 32 in NetLinX Studio's OnLine Tree. Follow the instructions on the top of page 61 to prepare for IRL file transfer and the instructions on page 62 for the actual transfer.

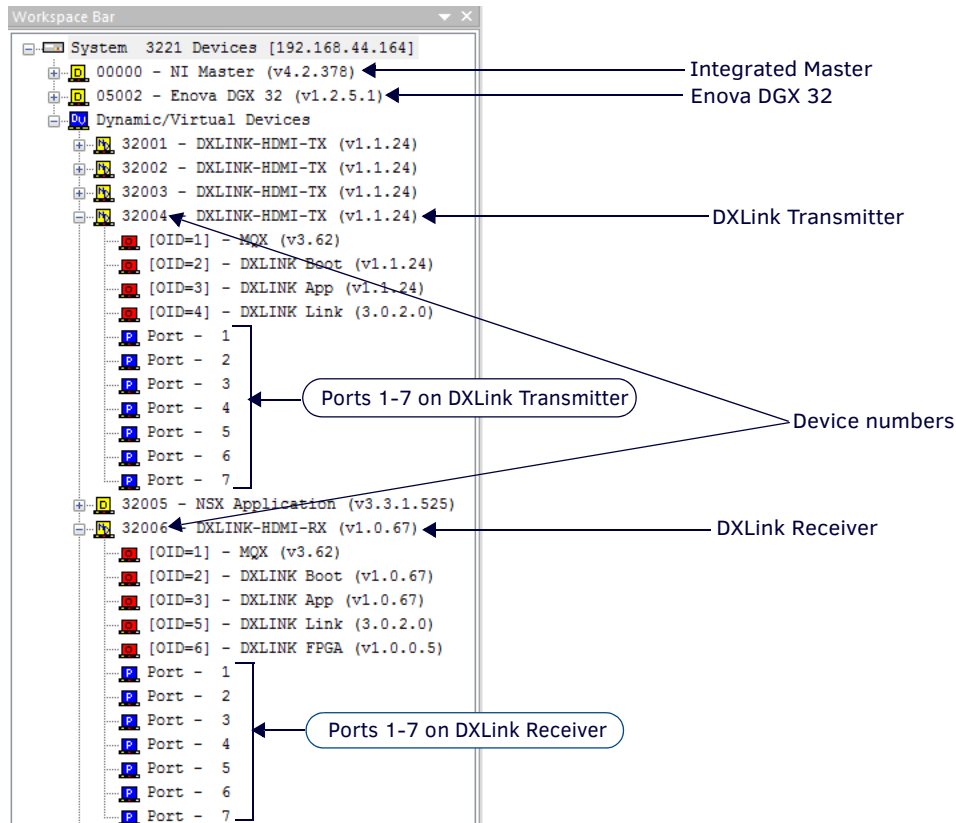

FIG. 38 NetLinX Studio – Integrated Master, Enova DGX 32, DXLink Transmitter, and DXLink Receiver

Preparing for IRL File Transfers

To prepare for IRL file transfers:

1. Check to be sure #3 Toggle on the bottom of the Transmitter or Receiver is set to ON.
2. Verify that you have the latest version of NetLinx Studio on your PC.

If the version is not the latest –

 - Use the Web Update option in NetLinx Studio's Help menu to obtain the latest version.

Or

 - Go to www.amx.com and login as a Dealer to download the latest version.
3. Download the applicable IRL file from www.amx.com (Partners / Search Devices) to your PC.
4. Verify the following:
 - a. Verify that an Ethernet/RJ-45 cable is connected from the switcher's integrated Master to the network (e.g., from the LAN 100/1000 port on the Enova DGX to a LAN).
 - b. Verify that the target Transmitter or Receiver is connected via its DXLink connector to a DXLink Input or Output Board (respectively) on the switcher.
 - c. Verify that the switcher is powered on.
5. Launch NetLinx Studio and open the OnLine Tree.
6. Bind the target Transmitter or Receiver to the integrated Master:
 - a. Select and right-click the TX or RX in the Online Tree.
 - b. From the context sensitive menu, select Network Bind/Unbind Device.
 - c. Verify that the check box is selected. If not selected, select it now.
 - d. Click OK.

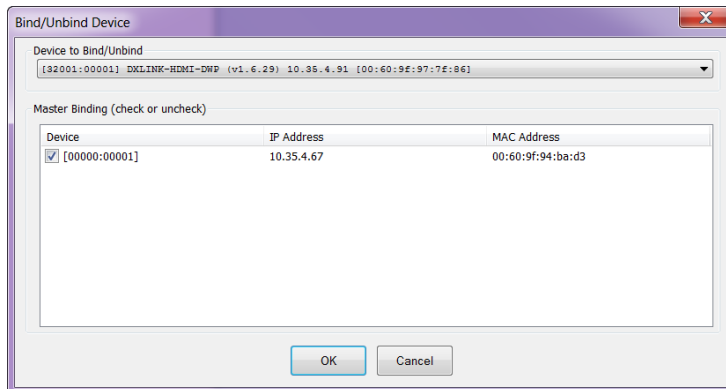

7. Determine the Device Number assigned to the target Transmitter or Receiver when it was bound. For the Device Number location, see FIG. 38 on the previous page.

The Transmitter or Receiver is ready for the IRL file transfer (see page 62).

Transferring IRL Files

The *File Transfer* tool in NetLinX Studio is used to map IRL files to DXLink Transmitters and Receivers. The instructions below assume that the preparations on the previous pages have been completed.

To send an IR Library (*.IRL) file to a Transmitter or Receiver:

1. In NetLinX Studio, select Tools > File Transfer to open the File Transfer dialog box.

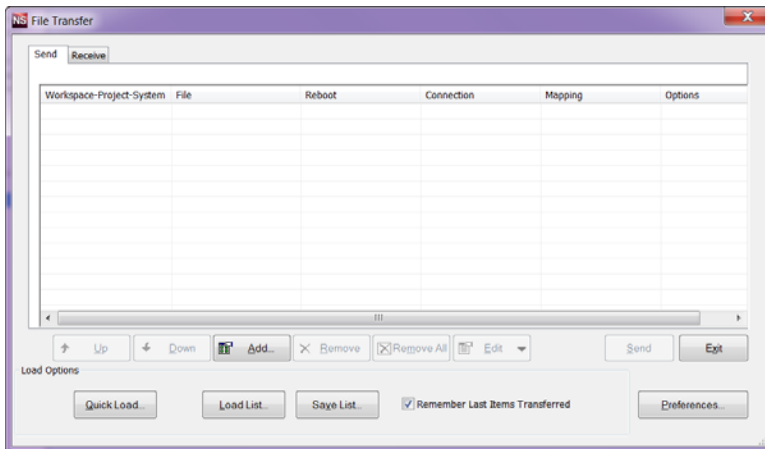

2. Click Add to open the Select Files for File Transfer dialog box.
3. Open the Other tab (if the file you want to transfer is not included in the open workspace.)
The Other tab consists of a display of different types of files that can be transferred to a Master or System devices on the bus.

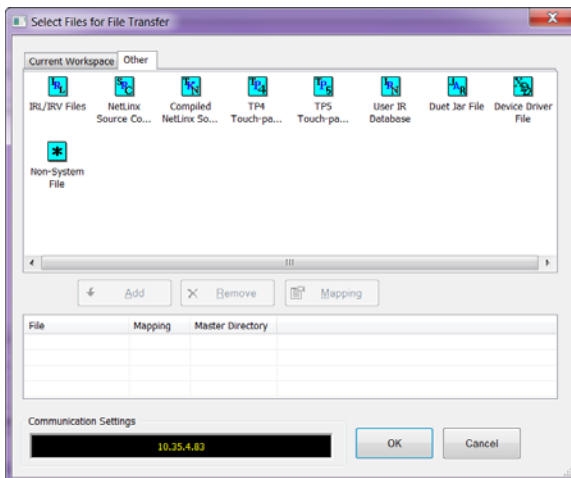

4. Select the type of file (in this case, IRL/IRV Files) that you want to add to the File list for transfer.

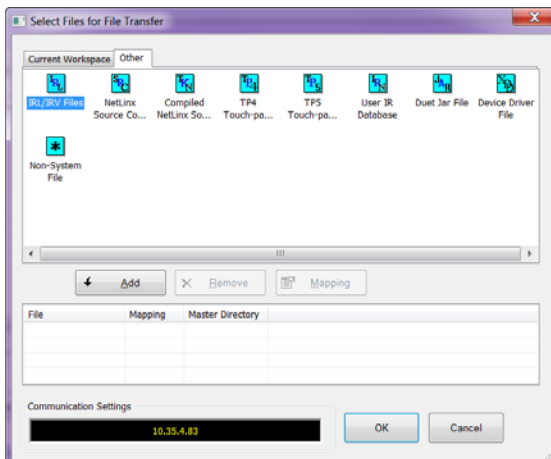

5. Click Add.
A standard Open dialog box opens with the Files of type selection set to IR Code files (*.IRL/*.IRV).

6. Locate and select the IRL file that you want to add.
7. Click Open.
The Enter Device Mapping Information dialog box opens.

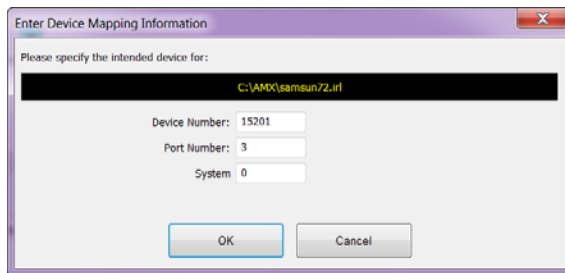

NOTE: IRL files must be sent to Port 3 (IR Device Port) on the Transmitter or Receiver.

8. If the fields are empty – Enter the Device, Port, and System numbers for the selected device.
If the fields are populated – Verify that the mapping information is correct for the selected device.
 - IRL files are sent to Port 3 (IR Device Port) on the Transmitter or Receiver.
 - Refer to the “Device Numbering” section on page 64 for information on device numbering for the Transmitter or Receiver.
 - If the device’s assigned device number has been changed, use the OnLine Tree to determine it.
9. Click OK to return to the Select Files for File Transfer dialog box.
The selected IRL file and its mapping information are indicated in the File and Mapping lists.
10. Click OK to close the Select Files for File Transfer dialog box and return to the File Transfer dialog box. The IRL file appears in the File queue.

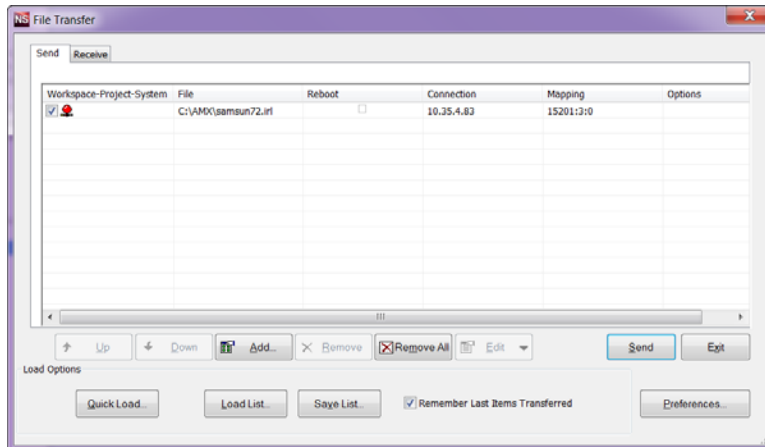

11. Click Send to transfer the file to the Transmitter or Receiver that the file is mapped to.

Additional Documentation

For additional information on using NetLinX Studio, refer to the *WebConsole & Programming Guide – NI & DVX Central Controllers* and the *WebConsole & Programming Guide – NX-Series Controllers* (available at www.amx.com).

Additional IRL Information

Unlike NetLinX NI-Controllers, ICSLan powered devices (such as the DXLink Transmitter and Receiver units) are not capable of having their IRL files received via the File Transfer dialog box, nor do they support the SEND_COMMAND: LOADIRL.

NetLinx Programming of DXLink Transmitters and Receivers

Overview

IMPORTANT: Before DXLink TXs and RXs can receive any NetLinx SEND_COMMANDs, the DIP switch's #3 Toggle must be set to ON or the devices will not be accessible from a NetLinx control system.

- The DXLink Transmitters and Receivers recognize a select number of SEND_COMMANDs and CHANNELs.
- Receiver Video SEND_COMMANDs – page 66
- Receiver Audio SEND_COMMANDs – page 68
- Transmitter Video SEND_COMMANDs – page 68
- Transmitter Audio SEND_COMMANDs – page 72
- IR SEND_COMMANDs and CHANNELs – page 73
- SERIAL SEND_COMMANDs – page 76
- Transmitter USB SEND_COMMANDs – page 77
- Receiver USB SEND_COMMANDs – page 78
- Common DXLink Transmitter / Receiver SEND_COMMANDs – page 78
- DXLink System SEND_COMMANDs – page 79
- SEND_STRING Escape Sequences – page 81

Also provided in this chapter are DXLink SEND_COMMANDs specifically for Enova DVX Switchers (see page 82).

NOTE: For a listing of all supported Telnet commands, see page 93.

Device Numbering and Ports

Each DXLink Transmitter and Receiver has its own Device Number (which is assigned when the unit is bound to a Master) and the following ports.

Transmitters and Receivers (Modules)

Port 1 – Serial
 Port 2 – Not used
 Port 3 – IR TX
 Port 4 – IR RX
 Port 5 – USB
 Port 6 – Video/Audio Output
 Port 7 – Video/Audio Input
 Port 8 (DX-TX only) – Analog Video Input

Transmitters (Wallplate TX and Decor Wallplate TX)

Port 1 – Serial
 Port 2 – Not used
 Port 3 – Not used
 Port 4 – Not used
 Port 5 – USB
 Port 6 – Video/Audio Output
 Port 7 – Video/Audio Input
 Port 8 – Analog Video Input

For an example of port numbering, see the NetLinx Studio illustration in FIG. 39 on the next page.

In NetLinX Studio's OnLine Tree, the DXLink Transmitters and Receivers each display their ports.

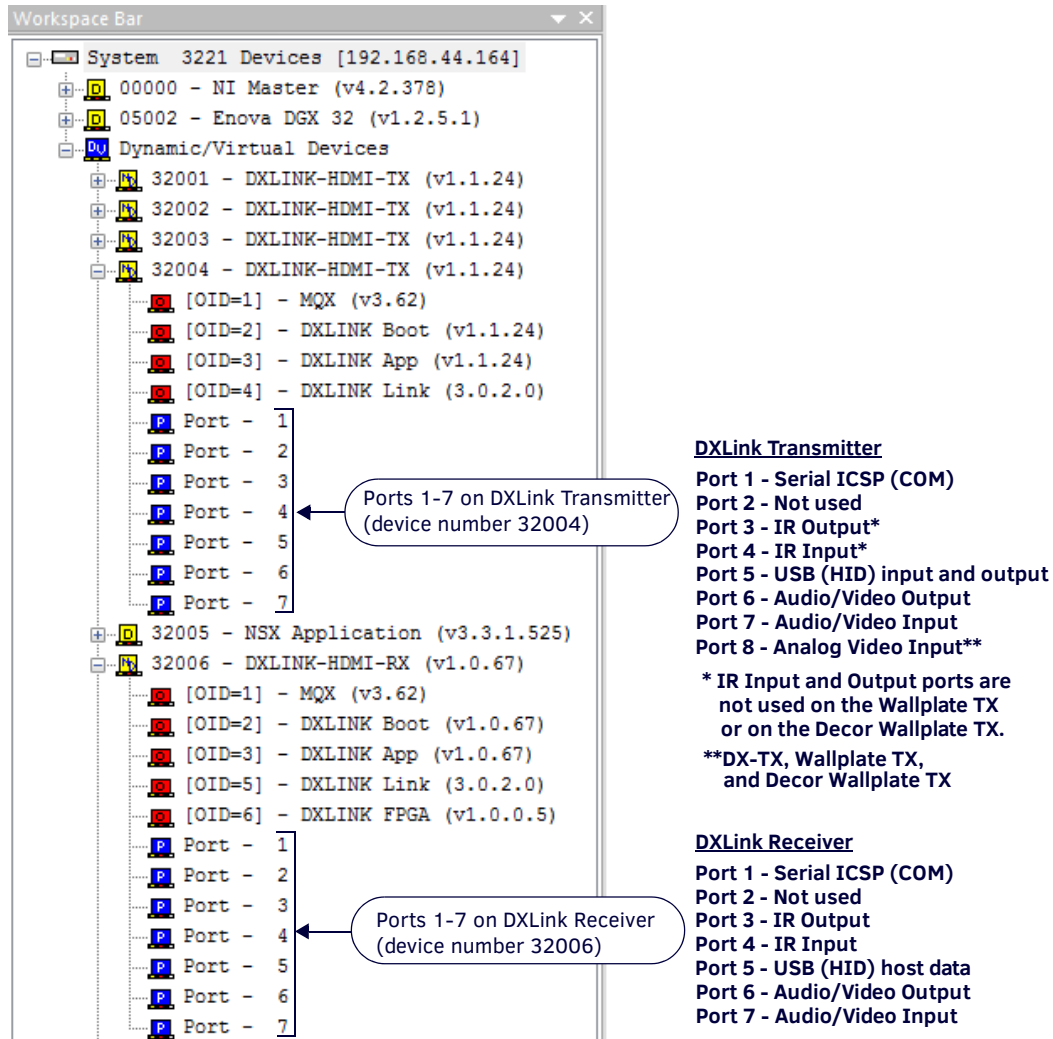

FIG. 39 NetLinX Studio OnLine Tree - Ports 1 through 7 on a DXLink Transmitter and Receiver

NOTE: For additional information on NetLinX Studio, refer to the "WebConsole & Programming Guide – NI & DVX Central Controllers" and the "WebConsole & Programming Guide – NX-Series Controllers" (available at www.amx.com).

NOTE: All command text is based on a Unicode index.

TIP: Occasionally new firmware versions affect SEND_COMMANDS. If a command does not produce the expected results, we suggest checking the product's current firmware version against the information in the "Firmware Version" table on page 89.

CHANNELS

Channel	Function
255	This channel On indicates that the DXLink Module has a valid UTP (twisted pair cable) connection to a switcher with an Integrated Master. If the channel is Off, the DXLink Module is incorrectly connected. 1-253 Key presses from selected remote control.

IMPORTANT: Before DXLink TXs and RXs can receive any NetLinX SEND_COMMANDS, the DIP switch's #3 Toggle must be set to ON or the devices will not be accessible from a NetLinX control system.

NOTE: Since not all devices support both upper and lower case, for best results all commands and parameters should be sent in upper case.

DXLink Receiver Video SEND_COMMANDS

DXLink Receiver Video SEND_COMMANDS are sent to Port 6.

NOTE: Asynchronous notifications are not available for the Receivers via NetLinx Studio (or Telnet).

Video SEND_COMMANDS (Receivers), continued	
Command	Description
<p>?VIDOUT_SCALE</p> <p>Requests the current Scaling Mode that the Receiver is set to. The modes are AUTO (SmartScale®), MANUAL, and BYPASS.</p>	<p>Syntax: SEND_COMMAND <DEV>, "'?VIDOUT_SCALE' "</p> <p>Example: SEND_COMMAND dvRX, "'?VIDOUT_SCALE' "</p> <p>Returns a COMMAND of the form: VIDOUT_SCALE-<AUTO/MANUAL/BYPASS></p>
<p>VIDOUT_SCALE</p> <p>Sets the Scaling Mode on the Receiver to AUTO (SmartScale®), MANUAL, or BYPASS.</p>	<p>Syntax: SEND_COMMAND <DEV>, "'VIDOUT_SCALE-<scaling mode>' "</p> <p>Valid response: scaling mode = AUTO, MANUAL, BYPASS</p> <p>Example: SEND_COMMAND dvRX, "'VIDOUT_SCALE-MANUAL' "</p>
<p>?VIDOUT_RES_REF</p> <p>Requests the resolution and refresh rate of the video through the Receiver.</p> <p>NOTE: If the Scaling Mode is set to Bypass, the response will be "BYPASS."</p>	<p>Syntax: SEND_COMMAND <DEV>, "'?VIDOUT_RES_REF' "</p> <p>Valid responses:</p> <ul style="list-style-type: none"> horizontal = An integer value representing the horizontal. vertical = An integer value representing the vertical. May have an additional qualifier such as 'i' or 'p'. rate = An integer value representing the refresh rate. <p>Example: SEND_COMMAND dvRX, "'?VIDOUT_RES_REF' "</p> <p>Returns a COMMAND of the form: VIDOUT_RES_REF-<horizontal>x<vertical>,<rate></p>
<p>VIDOUT_RES_REF</p> <p>Sets the resolution and refresh rate of the video through the Receiver and also sets the Scaling Mode to MANUAL.</p> <p>IMPORTANT: The "valid responses" used must come from the Resolution Names listed in the table in the "Supported Output Resolutions" appendix on page 110.</p> <p>NOTE: The default for Manual Mode is 1280x1024,60.</p>	<p>Syntax: SEND_COMMAND <DEV>, "'VIDOUT_RES_REF-<horizontal>x<vertical>,<rate>' "</p> <p>Valid responses:</p> <ul style="list-style-type: none"> horizontal = An integer value representing the horizontal. vertical = An integer value representing the vertical. May have an additional qualifier such as 'p' or 'i'. rate = An integer value representing the refresh rate. <p>Example: SEND_COMMAND dvRX, "'VIDOUT_RES_REF-1920x1080p,60' "</p>
<p>?VIDOUT_RES</p> <p>Requests the resolution and refresh rate of the video through the Receiver.</p> <p>NOTE: If the Scaling Mode is set to Bypass, the response will be "BYPASS."</p>	<p>Syntax: SEND_COMMAND <DEV>, "'?VIDOUT_RES' "</p> <p>Valid responses:</p> <ul style="list-style-type: none"> horizontal = An integer value representing the horizontal. vertical = An integer value representing the vertical. May have an additional qualifier such as 'i' or 'p'. rate = An integer value representing the refresh rate. <p>Example: SEND_COMMAND dvRX, "'?VIDOUT_RES' "</p> <p>Returns a COMMAND of the form: VIDOUT_RES-<horizontal>x<vertical>,<rate></p>
<p>?VIDOUT_ASPECT_RATIO</p> <p>Requests the aspect ratio preference of the video through the Receiver. (For explanations of the ratio options, see page 67.)</p>	<p>Syntax: SEND_COMMAND <DEV>, "'?VIDOUT_ASPECT_RATIO' "</p> <p>Valid responses: ratio = STRETCH (default after FACTORYAV), MAINTAIN, ZOOM, ANAMORPHIC</p> <p>Example: SEND_COMMAND dvRX, "'?VIDOUT_ASPECT_RATIO' "</p> <p>Returns a COMMAND of the form: VIDOUT_ASPECT_RATIO-<ratio></p>

Video SEND_COMMANDS (Receivers), continued	
<p>VIDOUT_ASPECT_RATIO</p> <p>Sets the aspect ratio preference of the video through the Receiver to Stretch, Maintain, Zoom, or Anamorphic. (For explanations of the ratio options, see page 67.)</p>	<p>Syntax: SEND_COMMAND <DEV>, "'VIDOUT_ASPECT_RATIO-<ratio>' "</p> <p>Valid responses: ratio = STRETCH, MAINTAIN, ZOOM, ANAMORPHIC</p> <p>Example: SEND_COMMAND dvRX, "'VIDOUT_ASPECT_RATIO-ZOOM' "</p>
<p>?VIDOUT_TESTPAT</p> <p>Requests the test pattern setting on the Receiver.</p>	<p>Syntax: SEND_COMMAND <DEV>, "'?VIDOUT_TESTPAT' "</p> <p>Valid responses: pattern = OFF, COLOR BAR, GRAY RAMP, SMPTE BAR, HILOTRAK, PLUGE, X-HATCH</p> <p>Example: SEND_COMMAND dvRX, "'?VIDOUT_TESTPAT' "</p> <p>Returns a COMMAND of the form: VIDOUT_TESTPAT-<pattern></p>
<p>VIDOUT_TESTPAT</p> <p>Sets the test pattern to display. Can be sent in any Scaling Mode.</p>	<p>Syntax: SEND_COMMAND <DEV>, "'VIDOUT_TESTPAT-<pattern>' "</p> <p>Valid responses: pattern = OFF, COLOR BAR, GRAY RAMP, SMPTE BAR, HILOTRAK, PLUGE, X-HATCH</p> <p>Example: SEND_COMMAND dvRX, "'VIDOUT_TESTPAT-COLOR BAR' "</p>
<p>?VIDOUT_MUTE</p> <p>Requests the setting for the Mute preference applied to the image from the Receiver (Enable or Disable).</p>	<p>Syntax: SEND_COMMAND <DEV>, "'?VIDOUT_MUTE' "</p> <p>Example: SEND_COMMAND dvRX, "'?VIDOUT_MUTE' "</p> <p>Returns a COMMAND of the form: VIDOUT_MUTE-<ENABLE DISABLE></p>
<p>VIDOUT_MUTE</p> <p>Sets the Mute preference of the image from the Receiver to Enable (displays a blank screen) or Disable.</p>	<p>Syntax: SEND_COMMAND <DEV>, "'VIDOUT_MUTE-<ENABLE DISABLE>' "</p> <p>Example: SEND_COMMAND dvRX, "'VIDOUT_MUTE-ENABLE' "</p>

Aspect Ratio Options

Stretch (to fit) – This option (default) scales the video to full screen size in both horizontal and vertical directions regardless of the input aspect ratio. No data is cropped. However, the image may be distorted as needed to fill the screen. When Stretch is selected, black bars are not added by the scaler. However, if an image has originated from a source device with either horizontal or vertical black bars (e.g., letter box from a movie), the black bars will be considered as active video and will be included in the stretched video.

Maintain (aspect ratio) – This option maintains the incoming video's aspect ratio, but will scale the image until the display fills either horizontal or vertical direction first. If the vertical direction is filled first, then the video will have pillar box black bars on the sides of the display. If the horizontal direction is filled first, then the video will have letter box black bars on the top and bottom of the display.

Zoom – This option maintains the input aspect ratio while zooming the image to fill the screen in all directions. Image data may be lost on the top and bottom or to the left and right of the displayed image.

Anamorphic – This option is used with anamorphic formatted video sources so that images appear correctly on the display.

DXLink Receiver Audio SEND_COMMANDS

DXLink Receiver Audio SEND_COMMANDS are sent to Port 6.

Audio SEND_COMMANDS (Receivers)	
Command	Description
<p>?AUDOUT_MUTE</p> <p>Requests the setting for the Mute preference of the audio from the Receiver (Enable or Disable).</p>	<p>Syntax: SEND_COMMAND <DEV>, "'?AUDOUT_MUTE' "</p> <p>Example: SEND_COMMAND dvRX, "'?AUDOUT_MUTE' "</p> <p>Returns a COMMAND of the form: AUDOUT_MUTE-<ENABLE DISABLE></p>
<p>AUDOUT_MUTE</p> <p>Sets the Mute preference of the audio from the Receiver to Enable (no sound) or Disable.</p>	<p>Syntax: SEND_COMMAND <DEV>, "'AUDOUT_MUTE-<ENABLE DISABLE>' "</p> <p>Example: SEND_COMMAND dvRX, "'AUDOUT_MUTE-ENABLE' "</p>
<p>?AUDOUT_FORMAT</p> <p>Requests the audio format on the Receiver.</p>	<p>Syntax: SEND_COMMAND <DEV>, "'?AUDOUT_FORMAT' "</p> <p>Valid response: format = HDMI, ANALOG, ALL</p> <p>Example: SEND_COMMAND dvRX, "'?AUDOUT_FORMAT' "</p> <p>Returns a COMMAND of the form: AUDOUT_FORMAT-<format></p>
<p>AUDOUT_FORMAT</p> <p>Sets the audio format on the Receiver (default is ALL).</p>	<p>Syntax: SEND_COMMAND <DEV>, "'AUDOUT_FORMAT-<format>' "</p> <p>Valid response: format = HDMI, ANALOG, ALL</p> <p>Example: SEND_COMMAND dvRX, "'AUDOUT_FORMAT-ANALOG' "</p>

DXLink Transmitter Video SEND_COMMANDS

DXLink Transmitter Video SEND_COMMANDS are sent to Port 7 unless otherwise noted.

NOTE: Asynchronous notifications are available for the Transmitters via NetLinx Studio (and Telnet).

NOTE: All text is based on a Unicode index.

Video SEND_COMMANDS (Transmitters)	
Command	Description
<p>?VIDIN_AUTO_SELECT</p> <p>Requests setting for the Auto Select mode for the video input signal on the DX-TX, Wallplate TX, or Decor Wallplate TX (Enable or Disable).</p> <p>NOTE: This command applies to all DXLink Transmitters except the HDMI TX.</p>	<p>IMPORTANT: This command <u>must</u> be sent to Port 1 of the DXLink Transmitter.</p> <p>IMPORTANT: If a Solecis switcher is used to transport the source's signal to an Enova DGX switcher, this command must be sent directly to the Solecis unit.</p> <p>Syntax: SEND_COMMAND <DEV>, "'?VIDIN_AUTO_SELECT' "</p> <p>Example: SEND_COMMAND dvMFTX, "'?VIDIN_AUTO_SELECT' "</p> <p>Returns a COMMAND of the form: VIDIN_AUTO_SELECT-ENABLE</p>
<p>VIDIN_AUTO_SELECT</p> <p>Enables or disables the Auto Select mode for the video input signal on the DX-TX, Wallplate TX, or Decor Wallplate TX.</p> <p>NOTE: This command applies to all DXLink Transmitters except the HDMI TX.</p>	<p>IMPORTANT: This command <u>must</u> be sent to Port 1 of the DXLink Transmitter.</p> <p>IMPORTANT: If a Solecis switcher is used to transport the source's signal to an Enova DGX switcher, this command must be sent directly to the Solecis unit.</p> <p>Syntax: SEND_COMMAND <DEV>, "'VIDIN_AUTO_SELECT-<ENABLE DISABLE>' "</p> <p>Valid response: value = ENABLE DISABLE</p> <p>Example: SEND_COMMAND dvMFTX, "'VIDIN_AUTO_SELECT-ENABLE' "</p> <p>NOTE: VIDIN_AUTO_SELECT <u>must</u> be set to "DISABLE" for a VIDIN_FORMAT command to take effect.</p>

Video SEND_COMMANDS (Transmitters)	
<p>?INPUT-VIDEO</p> <p>Requests the video input being used on the DX-TX, Wallplate TX, or Decor Wallplate TX: either the digital video (Input 7) or the analog video (Input 8). The output is always 6.</p> <p>NOTE: This command applies to all DXLink Transmitters except the HDMI TX.</p>	<p>IMPORTANT: This command <u>must</u> be sent to Port 1.</p> <p>Syntax: SEND_COMMAND <DEV>, "'?INPUT-VIDEO,6'"</p> <p>Example: SEND_COMMAND dvMFTX, "'?INPUT-VIDEO,6'" Returns a COMMAND of the form: SWITCH-LVIDEOI806</p>
<p>VI<input>O<output></p> <p>Sets the DX-TX, Wallplate TX, or Decor Wallplate TX to route either the digital video (Input 7) or the analog video (Input 8) to the output (which is always output 6).</p> <p>NOTE: This command applies to all DXLink Transmitters except the HDMI TX.</p>	<p>IMPORTANT: This command <u>must</u> be sent to Port 1.</p> <p>Syntax: SEND_COMMAND <DEV>, "'VI<input>O<output>'"</p> <p>Valid responses:</p> <ul style="list-style-type: none"> input = 7 for digital video; 8 for analog video output = 6 <p>Example: SEND_COMMAND dvMFTX, "'VI806'"</p>
<p>?VIDIN_STATUS</p> <p>Requests the status of the video input on the Transmitter.</p>	<p>IMPORTANT: Send to Port 7 for digital video or to Port 8 for analog video.</p> <p>Syntax: SEND_COMMAND <DEV>, "'?VIDIN_STATUS'"</p> <p>Valid response: status = NO SIGNAL, UNKNOWN SIGNAL, VALID SIGNAL</p> <p>Example: SEND_COMMAND dvMFTX, "'?VIDIN_STATUS'" Returns a COMMAND of the form: VIDIN_STATUS-<status></p>
<p>?VIDIN_FORMAT</p> <p>Requests the video format on the Transmitter.</p> <p>NOTE: All DXLink Transmitters except the HDMI TX support component, S-Video, composite, and VGA signals.</p>	<p>NOTE: Send to Port 7 or Port 8.</p> <p>Syntax: SEND_COMMAND <DEV>, "'?VIDIN_FORMAT'"</p> <p>Valid response:</p> <ul style="list-style-type: none"> format (port 8) = COMPONENT, S-VIDEO, COMPOSITE, VGA format (port 7) = HDMI, DVI <p>Example: SEND_COMMAND dvMFTX, "'?VIDIN_FORMAT'" Returns a COMMAND of the form: VIDIN_FORMAT-<format></p>
<p>VIDIN_FORMAT</p> <p>Sets the video format on the Transmitter (prior to sending, VIDIN_AUTO_SELECT must be set to DISABLE).</p> <p>NOTE: All DXLink Transmitters except the HDMI TX support component, S-Video, composite, and VGA signals</p>	<p>NOTE: Send to Port 7 or Port 8.</p> <p>Syntax: SEND_COMMAND <DEV>, "'VIDIN_FORMAT-<format>'"</p> <p>Valid response:</p> <ul style="list-style-type: none"> format (port 8) = COMPONENT, S-VIDEO, COMPOSITE, VGA format (port 7) = HDMI, DVI <p>Example: SEND_COMMAND dvMFTX, "'VIDIN_FORMAT-COMPONENT'"</p>
<p>?VIDIN_RES_REF</p> <p>Requests the resolution and refresh rate of the video through the Transmitter.</p>	<p>NOTE: Send to Port 7 or Port 8.</p> <p>Syntax: SEND_COMMAND <DEV>, "'?VIDIN_RES_REF'"</p> <p>Valid responses:</p> <ul style="list-style-type: none"> horizontal = An integer value representing the horizontal. vertical = An integer value representing the vertical. May have an additional qualifier such as 'i' or 'p'. rate = An integer value representing the refresh rate. <p>Example: SEND_COMMAND dvMFTX, "'?VIDIN_RES_REF'" Returns a COMMAND of the form: VIDIN_RES_REF-<horizontal>x<vertical>,<rate></p>

Video SEND_COMMANDs (Transmitters)	
<p>VIDIN_RES_REF</p> <p>Sets the resolution and refresh rate of the video through the Transmitter.</p>	<p>IMPORTANT: <i>Send to Port 7 or Port 8.</i></p> <p>Syntax: SEND_COMMAND <DEV>, "'VIDIN_RES_REF- <horizontal>x<vertical>,<rate>' "</p> <p>Valid responses:</p> <ul style="list-style-type: none"> horizontal = An integer value representing the horizontal. vertical = An integer value representing the vertical. May have an additional qualifier such as 'i' or 'p'. rate = An integer value representing the refresh rate.
<p>?VIDIN_PREF_EDID</p> <p>Requests the preferred resolution of the EDID source for the VGA video input.</p> <p>NOTE: <i>This command applies to all DXLink Transmitters except the HDMI TX.</i></p>	<p>IMPORTANT: <i>Send to Port 8.</i></p> <p>Syntax: SEND_COMMAND <DEV>, "'?VIDIN_PREF_EDID' "</p> <p>Example: SEND_COMMAND dvMFTX, "'?VIDIN_PREF_EDID' "</p> <p>Returns a COMMAND of the form: VIDIN_PREF_EDID-<resolution,refresh></p>
<p>VIDIN_PREF_EDID</p> <p>Sets the preferred resolution of the EDID source for the VGA video input.</p> <p>NOTE: <i>This command applies to all DXLink Transmitters except the HDMI TX.</i></p>	<p>IMPORTANT: <i>Send to Port 8.</i></p> <p>Syntax: SEND_COMMAND <DEV>, "'VIDIN_PREF_EDID - <resolution,refresh>' "</p> <p>Valid response: resolution,refresh = <for supported input resolutions and refresh rates, see the tables starting on page 107></p> <p>Examples: SEND_COMMAND dvMFTX, "'VIDIN_PREF_EDID-1920x1080p,60' "</p>
<p>?VIDIN_EDID</p> <p>Requests which EDID is being presented to the source on the video port addressed by the D:P:S.</p>	<p>IMPORTANT: <i>Send to Port 8.</i></p> <p>Syntax: SEND_COMMAND <DEV>, "'?VIDIN_EDID' "</p> <p>Example: SEND_COMMAND VIDEO_INPUT_1, "'?VIDIN_EDID' "</p> <p>Returns a COMMAND of the form: VIDIN_EDID-<source></p> <p>(See the VIDIN_EDID command for the potential sources.)</p>
<p>VIDIN_EDID</p> <p>Sets the EDID to be presented to the source on the video input port addressed by the D:P:S.</p>	<p>IMPORTANT: <i>Send to Port 8 (or Port 7 - only for the last valid response listed).</i></p> <p>Syntax: SEND_COMMAND <DEV>, "'VIDIN_EDID-<source>' "</p> <p>Valid responses: source = ALL RESOLUTIONS, USER EDID 1* (Port 8 only) MIRROR OUT 1** (Port 7 only)</p> <p>Example: SEND_COMMAND VIDEO_INPUT_1, "'VIDIN_EDID-ALL RESOLUTIONS' "</p> <p>* "USER EDID 1" must be written to the TX using DGX Configuration Software (see page 120). ** The HDMI port mirrors downstream EDID of the connected DXLink device.</p> <p>TIP: <i>For troubleshooting purposes, "MIRROR OUT 1" can be sent to Port 7 of the TX (or Port 6 of the RX), which effectively acts like a hotplug and refreshes the EDID.</i></p>
<p>?VIDIN_HDCP</p> <p>Requests the video HDCP compliance of the video input port addressed by the D:P:S.</p>	<p>IMPORTANT: <i>Send to Port 7.</i></p> <p>Syntax: SEND_COMMAND <DEV>, "'?VIDIN_HDCP' "</p> <p>Example: SEND_COMMAND dvTX, "'?VIDIN_HDCP' "</p> <p>Returns a COMMAND of the form: VIDIN_HDCP-<ENABLE DISABLE></p>

Video SEND_COMMANDS (Transmitters)	
<p>VIDIN_HDCP</p> <p>Sets the video input HDCP compliance setting of the video input port addressed by the D:P:S.</p> <p>CAUTION: For sources (such as DVD and Blu-Ray players) that do not support non-compliant displays, disabling the HDCP compliance is <u>not</u> recommended and may affect DXLink performance.</p>	<p>IMPORTANT: Send to Port 7.</p> <p>NOTE: When VIDIN_HDCP is disabled, the addressed video input will appear to any source as not being HDCP compliant. For PC sources that encrypt all video when connected to an HDCP compliant display, disabling HDCP compliance on the input will cause the PC to send non-encrypted video which can then be routed to non-compliant displays and video conferencing systems.</p> <p>This command is not applicable to the analog video port.</p> <p>NOTE: After changing this setting, it may be necessary to disconnect and re-connect PC sources.</p> <p>Syntax: SEND_COMMAND <DEV>, "'VIDIN_HDCP-<ENABLE DISABLE>' "</p> <p>Example: SEND_COMMAND dvMTX, "'VIDIN_HDCP-ENABLE' "</p> <p>Enables the HDCP Compliance of video input port (#1 based on D:P:S).</p>
<p>?VIDIN_VSHIFT</p> <p>Requests the vertical shift value of the analog video input port addressed by the D:P:S.</p> <p>NOTE: This command applies to all DXLink Transmitters except the HDMI TX.</p>	<p>IMPORTANT: Send to Port 8.</p> <p>Syntax: SEND_COMMAND <DEV>, "'?VIDIN_VSHIFT' "</p> <p>Example: SEND_COMMAND dvMFTX, VIDEO_INPUT_8, "'?VIDIN_VSHIFT' "</p> <p>Returns a COMMAND of the form: VIDIN_VSHIFT-<value></p>
<p>VIDIN_VSHIFT</p> <p>Sets the vertical shift value of the analog video input port addressed by the D:P:S.</p> <p>NOTE: This command applies to all DXLink Transmitters except the HDMI TX.</p>	<p>IMPORTANT: Send to Port 8.</p> <p>Syntax: SEND_COMMAND <DEV>, "'VIDIN_VSHIFT-<value>' "</p> <p>Valid responses: value = -7..7</p> <p>Example: SEND_COMMAND dvMFTX, "'VIDIN_VSHIFT-2' "</p> <p>Sets the vertical shifting of analog video input port (#1 based on D:P:S) to 2 (shift upward).</p> <p>SEND_COMMAND dvMFTX, "'VIDIN_VSHIFT--3' "</p> <p>Sets the vertical shifting of analog video input port (#1 based on D:P:S) to -3 (shift downward).</p>
<p>?VIDIN_HSHIFT</p> <p>Requests the horizontal shift value of the analog video input port addressed by the D:P:S.</p> <p>NOTE: This command applies to all DXLink Transmitters except the HDMI TX.</p>	<p>IMPORTANT: Send to Port 8.</p> <p>Syntax: SEND_COMMAND <DEV>, "'?VIDIN_HSHIFT' "</p> <p>Example: SEND_COMMAND dvMFTX, "'?VIDIN_HSHIFT' "</p> <p>Returns a COMMAND of the form: VIDIN_HSHIFT-<value></p>
<p>VIDIN_HSHIFT</p> <p>Sets the horizontal shift value of the analog video input port addressed by the D:P:S.</p> <p>NOTE: This command applies to all DXLink Transmitters except the HDMI TX.</p>	<p>IMPORTANT: Send to Port 8.</p> <p>Syntax: SEND_COMMAND <DEV>, "'VIDIN_HSHIFT-<value>' "</p> <p>Valid responses: value = -50..50</p> <p>Examples: SEND_COMMAND dvMFTX, "'VIDIN_HSHIFT-2' "</p> <p>Sets the horizontal shifting of video input port (#1 based on D:P:S) to 2 (shift to right).</p> <p>SEND_COMMAND dvMFTX, "'VIDIN_HSHIFT--3' "</p> <p>Sets the horizontal shifting of video input port (#1 based on D:P:S) to -3 (shift to left).</p>
<p>?VIDIN_PHASE</p> <p>Requests the input phase of the RGB video input port addressed by the D:P:S.</p> <p>NOTE: This command applies to all DXLink Transmitters except the HDMI TX.</p>	<p>IMPORTANT: Send to Port 8.</p> <p>This command is valid only for inputs whose format is set to VGA.</p> <p>Syntax: SEND_COMMAND <DEV>, "'?VIDIN_PHASE' "</p> <p>Example: SEND_COMMAND dvMFTX, "'?VIDIN_PHASE' "</p> <p>Returns a COMMAND of the form: VIDIN_PHASE-<value></p>

Video SEND_COMMANDS (Transmitters)	
<p>VIDIN_PHASE</p> <p>Sets the input phase of the RGB video input port addressed by the D:P:S.</p> <p>NOTE: This command applies to all DXLink Transmitters except the HDMI TX.</p>	<p>IMPORTANT: Send to Port 8.</p> <p>This command is valid only for inputs whose format is set to VGA.</p> <p>Syntax: SEND_COMMAND <DEV>, "'VIDIN_PHASE-<value>'"</p> <p>Valid responses: value = 0..31</p> <p>Example: SEND_COMMAND dvMFTX, "'VIDIN_PHASE-23'"</p>

DXLink Transmitter Audio SEND_COMMANDS

DXLink Transmitter Audio SEND_COMMANDS are sent to Port 7.

Audio SEND_COMMANDS (Transmitters)	
Command	Description
<p>?AUDIN_FORMAT_AUTO</p> <p>Requests the setting (Enable or Disable) for automatically detecting the audio source format through the TX.</p>	<p>Syntax: SEND_COMMAND <DEV>, "'?AUDIN_FORMAT_AUTO'"</p> <p>Example: SEND_COMMAND dvTX, "'?AUDIN_FORMAT_AUTO'"</p> <p>Returns a COMMAND of the form: AUDIN_FORMAT-AUTO<ENABLE DISABLE></p>
<p>AUDIN_FORMAT_AUTO</p> <p>Sets audio source format to automatically detect the audio through the TX.</p>	<p>Syntax: SEND_COMMAND <DEV>, "'AUDIN_FORMAT_AUTO-<ENABLE DISABLE>'"</p> <p>Example: SEND_COMMAND dvTX, "'AUDIN_FORMAT_AUTO-ENABLE'"</p>
<p>?AUDIN_FORMAT</p> <p>Requests the setting for the audio source format.</p>	<p>Syntax: SEND_COMMAND <DEV>, "'?AUDIN_FORMAT'"</p> <p>Valid response: format = HDMI, SPDIF, ANALOG</p> <p>Example: SEND_COMMAND dvTX, "'?AUDIN_FORMAT'"</p> <p>Returns a COMMAND of the form: AUDIN_FORMAT-<format></p>
<p>AUDIN_FORMAT</p> <p>Selects the audio input source that will be embedded on the HDMI signal through the TX.</p> <p>NOTE: When the DX-TX is set to route digital video (input 7), you can select from the HDMI, SPDIF, or ANALOG audio inputs. When it is set to route analog video (input 8), you can only select the SPDIF or ANALOG audio input (see the VI<input>O<output> command).</p>	<p>Syntax: SEND_COMMAND <DEV>, "'AUDIN_FORMAT-<format>'"</p> <p>Valid response: format = HDMI, SPDIF, ANALOG</p> <p>Example: SEND_COMMAND dvTX, "'AUDIN_FORMAT-ANALOG'"</p> <p>IMPORTANT: The order of precedence (HDMI embedded audio, S/PDIF, analog) can be overridden with this command; however, you must first send AUDIN_FORMAT_AUTO-DISABLE to disable the auto format function, or the audio format will automatically switch back anytime the order of precedence is violated.</p> <p>NOTE: S/PDIF signals are not available over the Wallplate TX or Decor Wallplate TX.</p>

IR SEND_COMMANDS

DXLink Transmitter and Receiver Module IR CHANNELS and SEND_COMMANDS are sent to Port 3 (IR output).

IR CHANNELS

Channel	Function
1-255	Generate the IR or serial command assigned to that channel.

IR SEND_COMMANDS

IR SEND_COMMANDS (Transmitters and Receivers)	
Command	Description
CAROFF Disable the IR carrier signal until a 'CARON' Send Command is received.	Syntax: SEND_COMMAND <DEV> , " 'CAROFF' " Example: SEND_COMMAND IR_1 , " 'CAROFF' " Stops transmitting IR carrier signals to the IR port.
CARON Enable the IR carrier signals (default).	Syntax: SEND_COMMAND <DEV> , " 'CARON' " Example: SEND_COMMAND IR_1 , " 'CARON' " Starts transmitting IR carrier signals to the IR port.
CH Send IR pulses for the selected channel.	<ul style="list-style-type: none"> All channels below 100 are transmitted as two digits. If the IR code for ENTER (function #21) is loaded, an Enter will follow the number. If the channel is greater than or equal to (\geq) 100, then IR function 127 or 20 (whichever exists) is generated for the one hundred digit. <p>NOTE: Set the Pulse and Wait times with 'CTON' and 'CTOF' (see the next page).</p> Syntax: SEND_COMMAND <DEV> , " 'CH' , <channel number> " Valid response: channel number = 0 to 199 channels Example: SEND_COMMAND IR_1 , " 'CH' , 18 " The IR port on the DXLink TX or RX performs the following: <ul style="list-style-type: none"> Transmits IR signals for 1 (IR code 11). The transmit time is set with the CTON command. Waits until the time set with the CTOF command elapses. Transmits IR signals for 8 (IR code 18). Waits for the time set with the CTOF command to elapse. If the IR code for Enter (IR code 21) is programmed, the module performs the following steps: <ul style="list-style-type: none"> Transmits IR signals for Enter (IR code 21). Waits for the time set with the CTOF command to elapse.
CP Halt and clear all active or buffered IR commands, and then send a single IR pulse.	Pulse and Wait times can be set with the 'CTON' and 'CTOF' commands. Syntax: SEND_COMMAND <DEV> , " 'CP' , <code> " Valid response: code = IR port's channel value 0 to 252 (253 to 255 reserved). Example: SEND_COMMAND IR_1 , " 'CP' , 2 " Clears the active/buffered commands and pulses IR port's channel 2.
CTOF Set the duration of the Off time (no signal) between IR pulses for channel and IR function transmissions. Off time settings are stored in non-volatile memory.	This command sets the delay time between pulses generated by the 'CH' or 'XCH' Send Commands in tenths of seconds. Syntax: SEND_COMMAND <DEV> , " 'CTOF' , <time> " Valid response: time = 0 to 255. Given in 1/10th of a second increments. Default is 5 (0.5 seconds). Example: SEND_COMMAND IR_1 , " 'CTOF' , 10 " Sets the off time between each IR pulse to 1 second.

IR SEND_COMMANDs (Transmitters and Receivers)	
<p>CTON Set the total time of IR pulses transmitted and is stored in non-volatile memory.</p>	<p>This command sets the pulse length for each pulse generated by the 'CH' (see previous page) or 'XCH' (see next page) Send Commands in tenth of a second increments. Syntax: SEND_COMMAND <DEV>,"'CTON',<time>" Valid response: time = 0 to 255. Given in 1/10th of a second increments. Default is 5 (0.5 seconds). Example: SEND_COMMAND IR_1,"'CTON',20" Sets the IR pulse duration to 2 seconds.</p>
<p>GET BAUD Get the IR port's current communication parameters.</p>	<p>The port sends the parameters to the device that requested the information. Syntax: SEND_COMMAND <DEV>,"'GET BAUD'" Example: SEND_COMMAND dvRXRS232,"'GET BAUD'" The port responds with: Port <port #>,<baud>,<parity>,<data>,<stop></p>
<p>GET MODE Poll the IR/Serial port's configuration parameters and report the active mode settings to the device requesting the information. NOTE: Works with Port 3 only.</p>	<p>Syntax: SEND_COMMAND <DEV>,"'GET MODE'" The port responds with: <port #> <mode>,<carrier>,<io link channel>. Example: SEND_COMMAND IR_1,"'GET MODE'" The system could respond with: PORT 3 IR,CARRIER,IO LINK 0</p>
<p>IROFF Halt and clear all active or buffered IR commands being output on the designated port.</p>	<p>Syntax: SEND_COMMAND <DEV>,"'IROFF'" Example: SEND_COMMAND IR_1,"'IROFF'" Immediately halts and clears all IR output signals on the IR port.</p>
<p>SET BAUD Use to set the IR communication parameters. NOTE: Before sending the SET BAUD command, you <u>must</u> set the IR port to Data mode (for the SET MODE command, see page 74)</p>	<p>NOTE: This value is not saved in non-volatile memory and is reset to default (9600, N, 8, 1) at power-up. Syntax: SEND_COMMAND <DEV>,"'SET BAUD <baud>,<parity>,<data>,<stop>'" Valid responses: • baud = 9600, 4800, 2400, 1200, 600, 300, 150 • parity = N (none), O (odd), E (even), M (mark), S (space) • data = 7 or 8 data bits • stop = 1 or 2 stop bits NOTE: The only valid 9 bit combination is (baud),N,9,1. Example: SEND_COMMAND DEVICE_1,"'SET BAUD 1200,N,8,1'" Sets the DEVICE_1 port's communication parameters to 1200 baud, no parity, 8 data bits, and 1 stop bit.</p>
<p>SET MODE Set an IR port to either IR, Serial, or Data mode.</p>	<p>Syntax: SEND_COMMAND <DEV>,"'SET MODE'<mode>" Valid response: mode = • IR (standard IR output with carrier) • SERIAL (IR without carrier and waveform inverted) • DATA (1-way serial/TTL) Example: SEND_COMMAND IR_1,"'SET MODE IR'" Sets the IR_1 port to IR mode for IR control.</p>
<p>SP Generate a single IR pulse.</p>	<p>You can use the 'CTON' to set pulse lengths and the 'CTOF' to set time Off between pulses. Syntax: SEND_COMMAND <DEV>,"'SP',<code>" Valid response: code = IR code value 1 to 252 (253 to 255 reserved). Example: SEND_COMMAND IR_1,"'SP',25" Pulses IR code 25 on IR port on RX.</p>

IR SEND_COMMANDs (Transmitters and Receivers)	
<p>XCH Transmit IR codes.</p>	<p>Syntax: SEND_COMMAND <DEV>, "'XCH <channel>' "</p> <p>Valid response: channel = 0 to 999.</p> <p>NOTE: For detailed usage examples, refer to the 'XCHM' command.</p>
<p>XCHM Changes the IR output pattern for the 'XCH' Send Command.</p>	<p>Syntax: SEND_COMMAND <DEV>, "'XCHM <extended channel mode>' "</p> <p>Valid response: extended channel mode = 0 to 4.</p> <p>Example: SEND_COMMAND IR_1, "'XCHM 3' " Sets the IR device's extended channel command to mode 3.</p> <p>Mode 0 Example (default): [x][x]<x><enter> SEND_COMMAND IR_1, "'XCH 3' " Transmits the IR code as 3-enter. SEND_COMMAND IR_1, "'XCH 34' " Transmits the IR code as 3-4-enter. SEND_COMMAND IR_1, "'XCH 343' " Transmits the IR code as 3-4-3-enter.</p> <p>Mode 1 Example: <x><x><x><enter> SEND_COMMAND IR_1, "'XCH 3' " Transmits the IR code as 0-0-3-enter. SEND_COMMAND IR_1, "'XCH 34' " Transmits the IR code as 0-3-4-enter. SEND_COMMAND IR_1, "'XCH 343' " Transmits the IR code as 3-4-3-enter.</p> <p>Mode 2 Example: <x><x><x> SEND_COMMAND IR_1, "'XCH 3' " Transmits the IR code as 0-0-3. SEND_COMMAND IR_1, "'XCH 34' " Transmits the IR code as 0-3-4. SEND_COMMAND IR_1, "'XCH 343' " Transmits the IR code as 3-4-3.</p> <p>Mode 3 Example: [[100][100]....]<x><x> SEND_COMMAND IR_1, "'XCH 3' " Transmits the IR code as 0-3. SEND_COMMAND IR_1, "'XCH 34' " Transmits the IR code as 3-4. SEND_COMMAND IR_1, "'XCH 343' " Transmits the IR code as 100-100-100-4-3.</p> <p>Mode 4 Example:</p> <ul style="list-style-type: none"> • Mode 4 sends the same sequences as the 'CH' command. • Only use Mode 4 with channels 0 to 199.

Serial SEND_COMMANDS

DXLink Module SERIAL SEND_COMMANDS are sent to Port 1.

Serial SEND_COMMANDS (Transmitters and Receivers)	
Command	Description
<p>B9MOFF</p> <p>Set the port's communication parameters for stop and data bits according to the software settings on the RS-232 port.</p>	<p>This command works in conjunction with the 'B9MON' command.</p> <ul style="list-style-type: none"> Disables 9-bit in 232 mode. By default, this returns the Communication settings on the serial port to the last programmed parameters. <p>Syntax: B9MOFF</p> <p>Example: SEND_COMMAND SOMEDEVICE_1, " 'B9MOFF' "</p> <p>Sets the port settings on SOMEDEVICE to match the port's configuration settings.</p>
<p>B9MON</p> <p>Override and set the current communication settings and parameters on the RS-232 serial port to 9 data bits with one stop bit.</p>	<p>This command works in conjunction with the 'B9MOFF' command.</p> <ul style="list-style-type: none"> Enables 9-bit in 232 mode. <p>Syntax: B9MON</p> <p>Example: SEND_COMMAND SOMEDEVICE_1, " 'B9MON' "</p> <p>Resets the SOMEDEVICE port's communication parameters to nine data bits and one stop bit.</p>
<p>CHARD</p> <p>Set the delay time between all transmitted characters to the value specified (in 100 microsecond increments).</p>	<p>Syntax: SEND_COMMAND <DEV>, " 'CHARD-<time>' "</p> <p>Valid response: time = 0 to 10000 (1 second)</p> <p>Example: SEND_COMMAND dvRXRS232, " 'CHARD-10' "</p> <p>Sets a 1-millisecond delay between all transmitted characters.</p>
<p>CHARDM</p> <p>Set the delay time between all transmitted characters to the value specified (in 1 millisecond increments).</p>	<p>Syntax: SEND_COMMAND <DEV>, " 'CHARDM-<time>' "</p> <p>Valid response: time = 0 to 1000 (1 second)</p> <p>Example: SEND_COMMAND dvRXRS232, " 'CHARDM-10' "</p> <p>Sets a 10-millisecond delay between all transmitted characters.</p>
<p>ESCSEQOFF</p> <p>Disables SEND_STRING escape sequences</p>	<p>Disables SEND_STRING escape sequences (see the "SEND_STRING Escape Sequences" section on page 81).</p>
<p>ESCSEQON</p> <p>Enables SEND_STRING escape sequences</p>	<p>Enables SEND_STRING escape sequences (see the "SEND_STRING Escape Sequences" section on page 81).</p>
<p>GET BAUD</p> <p>Get the RS-232 (serial) port's current communication parameters.</p>	<p>The port sends the parameters to the device that requested the information.</p> <p>Syntax: SEND_COMMAND <DEV>, " 'GET BAUD' "</p> <p>Example: SEND_COMMAND dvRXRS232, " 'GET BAUD' "</p> <p>The port responds with: Port <port #>, <baud>, <parity>, <data>, <stop></p>
<p>RXCLR</p> <p>Clear all characters in the receive buffer waiting to be sent to the Master.</p>	<p>Syntax: SEND_COMMAND <DEV>, " 'RXCLR' "</p> <p>Example: SEND_COMMAND dvRXRS232, " 'RXCLR' "</p> <p>Clears all characters in the receive buffer waiting to be sent to the Master.</p>
<p>RXOFF</p> <p>Disable the transmission of incoming received characters to the Master (default).</p>	<p>Syntax: SEND_COMMAND <DEV>, " 'RXOFF' "</p> <p>Example: SEND_COMMAND dvRXRS232, " 'RXOFF' "</p> <p>Disables the transmission of incoming received characters to the Master.</p>

Serial SEND_COMMANDS (Transmitters and Receivers)	
<p>RXON Start transmitting received characters to the Master. Enables sending incoming received characters to the Master.</p>	<p>This command is automatically sent by the Master when a 'CREATE_BUFFER' program instruction is executed. Syntax: SEND_COMMAND <DEV>, "'RXON' " Example: SEND_COMMAND dvRXRS232, "'RXON' " Sets the RX RS-232 port to transmit received characters to the Master.</p>
<p>TXCLR Stop and clear all characters waiting in the transmit out buffer and stops transmission.</p>	<p>Syntax: SEND_COMMAND <DEV>, "'TXCLR' " Example: SEND_COMMAND dvRXRS232, "'TXCLR' " Stops and clears all characters waiting in the RX serial port's transmit buffer.</p>
<p>SET BAUD (shown in examples) Or TSET BAUD Use either of these commands to set the serial communication parameters. NOTE: DXLink Transmitters and Receivers only support RS-232 serial communication.</p>	<p>NOTE: This value is not saved in non-volatile memory and is reset to default (9600, N, 8, 1) at power-up. Syntax: SEND_COMMAND <DEV>, "'SET BAUD <baud>, <parity>, <data>, <stop>' " Valid responses: • baud = 115200, 76800, 57600, 38400, 19200, 9600, 4800, 2400, 1200, 600, 300, 150. • parity = N (none), O (odd), E (even), M (mark), S (space) • data = 7 or 8 data bits • stop = 1 or 2 stop bits NOTE: The only valid 9 bit combination is (baud),N,9,1. Example: SEND_COMMAND DEVICE_1, "'SET BAUD 115200,N,8,1' " Sets the DEVICE_1 port's communication parameters to 115,200 baud, no parity, 8 data bits, and 1 stop bit.</p>

DXLink Transmitter USB SEND_COMMANDS

DXLink Transmitter USB SEND_COMMANDS are sent to Port 5.

USB SEND_COMMANDS (Transmitter)	
Command	Description
<p>?USB_HID_SERVICE Requests the status for the USB HID pass through setting (Enable or Disable).</p>	<p>Syntax: SEND_COMMAND <DEV>, "'?USB_HID_SERVICE' " Example: SEND_COMMAND dvTX, "'?USB_HID_SERVICE' " Returns a COMMAND of the form: USB_HID_SERVICE-<ENABLE/DISABLE></p>
<p>USB_HID_SERVICE Sets the USB HID pass through to Enable or Disable.</p>	<p>NOTE: When enabled, the USB port addressed by D:P:S is running in auto switching mode. Syntax: SEND_COMMAND <DEV>, "'USB_HID_SERVICE-<ENABLE DISABLE>' " Example: SEND_COMMAND dvTX, "'USB_HID_SERVICE-ENABLE' " NOTE: This command persists through power cycling.</p>

DXLink Receiver USB SEND_COMMANDS

DXLink Receiver USB SEND_COMMANDS are sent to Port 5.

USB SEND_COMMANDS (Transmitter)	
Command	Description
?USB_HID_ROUTE Requests the IP address or hostname of the host device (Transmitter) sending USB keyboard/mouse data to the Receiver.	Syntax: SEND_COMMAND <DEV>, "'?USB_HID_ROUTE' " Example: SEND_COMMAND dvRX, "'?USB_HID_ROUTE' " Returns a COMMAND of the form: USB_HID_ROUTE-<IP address or hostname>
USB_HID_ROUTE Set the IP address or hostname of the host device (Transmitter) that will be sending USB keyboard/mouse data to the Receiver.	NOTE: When a hostname is specified, a maximum of 50 characters can be used. Syntax: SEND_COMMAND <DEV>, "'USB_HID_ROUTE-<IP address or hostname>' " Example: SEND_COMMAND dvRX, "'USB_HID_ROUTE-192.168.1.5' " NOTE: To eliminate the connection, specify 0.0.0.0 as the IP address. To redirect to a new host device (Transmitter), send the new IP address or hostname.

Common DXLink Transmitter / Receiver SEND_COMMANDS

Common NetLinx SEND_COMMANDS for the DXLink Transmitters and Receivers are provided in the following table.

These commands can be sent to any port (the #3 Toggle *must* be set to ON).

Common NetLinx SEND_COMMANDS (Transmitters and Receivers)	
Command	Description
?FWVERSION Requests the firmware version of the TX or RX.	Syntax: SEND_COMMAND <DEV>, "'?FWVERSION' " Example: SEND_COMMAND dvRX, "'?FWVERSION' " Returns a COMMAND of the form: FWVERSION <version-string>
LED-DIS Disable all LEDs to the right of the Program port.	Syntax: LED-DIS Example: SEND_COMMAND DEVICE_1, "'LED-DIS' " Disables all LEDs to the right of the Program port on DEVICE_1. NOTE: This parameter does not get stored in non-volatile memory. LEDs are enabled by default at each power-up.
LED-EN Enable all LEDs to the right of the Program port (default).	Syntax: LED-EN Example: SEND_COMMAND DEVICE_1, "'LED-EN' " Enables all LEDs to the right of the Program port on DEVICE_1.
REBOOT Reboot the module.	Syntax: REBOOT Example: SEND_COMMAND DEVICE_1, "'REBOOT' " Reboots DEVICE_1.
SET_NDX_DESC Set Friendly name and location for NDP.	Syntax: SET_NDX_DESC-friendly name:location <ul style="list-style-type: none"> Max of 25 characters for <i>friendly name</i> and max of 25 characters for <i>location</i>. If more than 25 characters are sent for either friendly name or location, they will be truncated to a max of 25 characters. Neither the friendly name nor the location should contain a ":" character, as that is used as a delimiter. NOTE: This command requires a reboot to enable new settings.

DXLink System SEND_COMMANDS

DXLink System SEND_COMMANDS can be sent to any port on the Transmitters or Receiver.

DXLink System SEND_COMMANDS (Transmitters and Receivers)	
Command	Description
?DXLINK Requests the current mode for the TX or RX.	Syntax: SEND_COMMAND <DEV>, "'?DXLINK' " Example: SEND_COMMAND dvRX, "'?DXLINK' " Returns a COMMAND of the form: DXLINK-<DXLINK-EXTENDER/DXLINK-ENDPOINT>
DXLINK Sets the TX or RX to Extender Mode (for a standalone, direct connection from module to module) or Endpoint Mode (for use in conjunction with a switcher).	Syntax: SEND_COMMAND <DEV>, "'DXLINK-<EXTENDER ENDPOINT>' " Example: SEND_COMMAND dvRX, "'DXLINK-EXTENDER' "
?DXLINKIN_LINK_STATUS Requests if an Endpoint is connected to the DXLink Input Port.	Syntax: SEND_COMMAND <DEV>, "'?DXLINKIN_LINK_STATUS' " Example: SEND_COMMAND dxTX, "'?DXLINKIN_LINK_STATUS' " Returns a COMMAND string of the form: DXLINKIN_LINK_STATUS-<DISCONNECTED CONNECTED>
?DXLINKOUT_LINK_STATUS Requests if an Endpoint is connected to the DXLink Output Port.	Syntax: SEND_COMMAND <DEV>, "'?DXLINKOUT_LINK_STATUS' " Example: SEND_COMMAND dvRX, "'?DXLINKOUT_LINK_STATUS' " Returns a COMMAND string of the form: DXLINKOUT_LINK_STATUS-<DISCONNECTED CONNECTED>
?DXLINKIN_QUALITY Requests a value that represents the quality of the signal between a DXLink Input Port and an Endpoint.	Syntax: SEND_COMMAND <DEV>, "'?DXLINKIN_QUALITY' " Example: SEND_COMMAND dvTX, "'?DXLINKIN_QUALITY' " Returns a COMMAND string of the form: DXLINKIN_QUALITY--22
?DXLINKOUT_QUALITY Requests a value that represents the quality of the signal between a DXLink Output Port and an Endpoint.	Syntax: SEND_COMMAND <DEV>, "'?DXLINKOUT_QUALITY' " Example: SEND_COMMAND dvRX, "'?DXLINKOUT_QUALITY' " Returns a COMMAND string of the form: DXLINKOUT_QUALITY--22
?DXLINKIN_QUALITY_ALARM The alarm is triggered when the DXLink cable quality is beyond the threshold where overall performance issues are likely to occur.	Syntax: SEND_COMMAND <DEV>, "'?DXLINKIN_QUALITY_ALARM' " Example: SEND_COMMAND dvTX, "'?DXLINKIN_QUALITY_ALARM' " Returns a COMMAND string of the form: DXLINKIN_QUALITY_ALARM-OFF or DXLINKIN_QUALITY_ALARM-ON
?DXLINKOUT_QUALITY_ALARM The alarm is triggered when the DXLink cable quality is beyond the threshold where overall performance issues are likely to occur.	Syntax: SEND_COMMAND <DEV>, "'?DXLINKOUT_QUALITY_ALARM' " Example: SEND_COMMAND dvRX, "'?DXLINKOUT_QUALITY_ALARM' " Returns a COMMAND string of the form: DXLINKOUT_QUALITY_ALARM-OFF or DXLINKOUT_QUALITY_ALARM-ON
ICSLAN Sets the ICS LAN connection to Enable or Disable.	Syntax: SEND_COMMAND <DEV>, "'ICSLAN-<ENABLE DISABLE>' " Example: SEND_COMMAND dvRX, "'ICSLAN-ENABLE' "

DXLink System SEND_COMMANDS (Transmitters and Receivers)	
<p>PERSISTAV DX-RX: Only used to save the Receiver's Power-On Scaler settings/ mode to the DGX DXLink Output Boards for DGX Configuration Software. Not required to save A/V settings to the receiver. These are automatically saved when changes are made. All Transmitters: Disables the AUDIN_FORMAT_AUTO and persists the current audio format.</p>	<p>Syntax: SEND_COMMAND <DEV> , "'PERSISTAV' " Example: SEND_COMMAND dvRX , "'PERSISTAV' "</p>
<p>FACTORYAV DX-RX: Clears the persisted settings for the Scaler mode,* resolution, aspect ratio policy, and audio output type and restores them to their factory defaults. * The "Power-On" Scaler mode on an Enova DGX DXLink Output Board will not get reset to default (AUTO), but will remain as whatever was last persisted. All Transmitters: Clears the persisted setting for the audio and video formats and restores them to their factory defaults. Also restores the preferred EDID to the factory default on the HD-15 input to 1920x1080P,60.</p>	<p>Syntax: SEND_COMMAND <DEV> , "'FACTORYAV' " Example: SEND_COMMAND dvTX , "'FACTORYAV' " NOTE: A reboot is required after sending the FACTORYAV command.</p>
<p>SET TELNET PORT 0 Sets the Telnet port to "0" (disabled state).</p>	<p>Syntax: SEND_COMMAND <DEV> , "'SET TELNET PORT 0' " Example: SEND_COMMAND dvRX , "'SET TELNET PORT 0' " NOTE: A reboot is required after sending the SET TELNET PORT 0 command.</p>
<p>SET TELNET PORT 23 Sets the Telnet port to "23" (default port).</p>	<p>Syntax: SEND_COMMAND <DEV> , "'SET TELNET PORT 23' " Example: SEND_COMMAND dvRX , "'SET TELNET PORT 23' " NOTE: A reboot is required after sending the SET TELNET PORT 23 command.</p>

SEND_STRING Escape Sequences

The DXLink Modules support several special SEND_STRING escape sequences. If any of the character combinations listed below are found anywhere within a SEND_STRING program instruction, they will be treated as a command and not the literal characters.

Use the ESCSEQON and ESCSEQOFF NetLinx SEND_COMMANDS to control whether these are active or not. The ESCSEQON command *must* precede the Escape Sequences, otherwise strings will be processed normally. These commands are sent to Port 1.

SEND_STRING Escape Sequences	
Command	Description
27, 17 Send a break character for a specified duration to a specific device.	Syntax: 27,17,<time> Valid response: time = 1 to 255 (measured in 100 microsecond increments) Example: SEND_STRING RS232_1, "27,17,10" Sends a break character of 1 millisecond to the RS232_1 device.
27, 18, 0 Clear the ninth data bit by setting it to 0 on all character transmissions.	Used in conjunction with the 'B9MON' command (see page 76). Syntax: 27,18,0 Example: SEND_STRING RS232_1, "27,18,0" Sets the RS232_1 device's ninth data bit to 0 on all character transmissions.
27, 18, 1 Set the ninth data bit to 1 for all subsequent characters to be transmitted.	Used in conjunction with the 'B9MON' command (page 76). Syntax: 27,18,1 Example: SEND_STRING RS232_1, "27,18,1" Sets the RS232_1 device's ninth data bit to 1 on all character transmissions.
27, 19 Insert a time delay before transmitting the next character.	Syntax: 27,19,<time> Valid response: time = 1 to 255. Measured in 1 millisecond increments. Example: SEND_STRING RS232_1, "27,19,10" Inserts a 10 millisecond delay before transmitting characters to the RS232_1 device.

Enova DVX Switchers – DXLink SEND_COMMANDS

The following table contains two DXLink SEND_COMMANDS that are specifically for Enova DVX Switchers. These commands persist during a power cycle, on reboot, or from a low power setting.

Additional SEND_COMMANDS for Enova DVX Switchers can be found in the specific product manual at www.amx.com.

IMPORTANT: The #3 Toggle on the Transmitter or Receiver must be set to ON before the commands in the table below are sent to the switcher.

Enova DVX Solution DXLink SEND_COMMANDS	
Command	Description
<p>?DXLINK_ETH Requests the control setting for the DXLink output card on an Enova DVX Switcher.</p>	<p>Syntax: SEND_COMMAND <DEV>, "'?DXLINK_ETH' "</p> <p>Example: SEND_COMMAND SWITCHER, "'?DXLINK_ETH' "</p> <p>Returns a COMMAND of the form: DXLINK_ETH-<AUTO OFF></p>
<p>DXLINK_ETH Controls Ethernet traffic through the DXLink output card on an Enova DVX Switcher.</p>	<p>This command instructs the DXLink output card on an Enova DVX Switcher to disable Ethernet traffic or go to Auto mode. In Auto mode, Ethernet traffic is controlled after negotiation through PDIF.</p> <p>Syntax: SEND_COMMAND <DEV>, "'DXLINK_ETH-<AUTO OFF>' "</p> <p>Example: SEND_COMMAND SWITCHER, "'DXLINK_ETH-AUTO' "</p>
<p>?DXLINK_IN_ETH Requests the control setting for the DXLink input card on an Enova DVX Switcher.</p>	<p>Syntax: SEND_COMMAND <DEV>, "'?DXLINK_IN_ETH' "</p> <p>Example: SEND_COMMAND SWITCHER, "'?DXLINK_IN_ETH' "</p> <p>Returns a COMMAND of the form: DXLINK_IN_ETH-<AUTO OFF></p>
<p>DXLINK_IN_ETH Controls Ethernet traffic through the DXLink input card on an Enova DVX Switcher.</p>	<p>This command instructs the DXLink input card on an Enova DVX Switcher to disable Ethernet traffic or go to Auto mode. In Auto mode, Ethernet traffic is controlled after negotiation through PDIF.</p> <p>Syntax: SEND_COMMAND <DEV>, "'DXLINK_IN_ETH-<AUTO OFF>' "</p> <p>Example: SEND_COMMAND SWITCHER, "'DXLINK_IN_ETH-AUTO' "</p>

NOTE: For a listing of all supported Telnet commands, see page 93.

Troubleshooting

Overview

The troubleshooting suggestions/strategies provided apply to the Transmitters and the Receiver, unless otherwise noted.

Five potential types of issues are covered in this chapter:

- Basic troubleshooting
- Determining HDCP compliance
- Power
- DXLink connections
- Network setup

This chapter also provides technical support contact information on page 86.

Basic Troubleshooting

We suggest using the following general list to rule out basic troubleshooting issues.

- Check the power indicator LEDs on all of the equipment. If any are not illuminated, see the “Power Issues” section below.
- Check all link and signal connections to make sure everything is physically set up correctly.
- Isolate source and destination equipment and cable problems by cabling direct without the DXLink units.
- Check the DIP switch’s toggle settings (see page 34).
- SEND_COMMANDS – double-check the command and the port number specified and re-send the command (see page 64).
- If any changes have been made, try resetting the unit to the factory defaults (see page 57).

Additional Resources for Troubleshooting Switching Systems

Enova DGX Digital Media Switchers

When the DXLink units are used in conjunction with an Enova DGX Switcher, we suggest checking the troubleshooting information in that product’s manual.

Enova DVX Solutions

When DXLink units are used in conjunction with an Enova DVX Solution, we suggest: pressing the Status button on the front panel and using the UP and DOWN navigational buttons to scroll through the menu options to Diagnostic Codes (the codes can be helpful for technical support if a call is necessary).

Determining HDCP Compliance

A dark red or an orange screen on an output display is the visual cue from DXLink devices that the display device cannot display the HDCP compliant signal from the source.

Power Issues

Upon power up, the Power indicator LED on the front of the DXLink units illuminates solid green.

If the Power LEDs on any of the system’s equipment are not illuminated:

- Check the power cords or DXLink (RJ-45) connection if using power over the DXLink line.
- Check the power connections on the switcher if using power over the DXLink line.
- Check the power connections on the source and destination devices.

DXLink Power Delivery Issues

Unexpected power interruptions of DXLink Transmitters and Receivers may be caused by the Enova DGX Digital Media Switcher being powered by single phase power. Connecting a ground wire to the DXLink unit’s chassis and a common earthed ground (ideally, referenced to the switcher) will stop power interruptions. For information on when and how to attach ground wires to DXLink units, see page 37.

Important Power Considerations for Enova DGX Systems

- Local power – Local power (the desktop power supply) always takes precedence over power via the DXLink line from the switcher. However, if a locally powered module is connected to a switcher and the local power is lost (i.e., unplugged or turned off), the module will power down and then automatically power back up using power from the switcher via the DXLink connection (increasing the overall power draw on the switcher). When local power is restored, it automatically replaces the power over the DXLink line.
- DXLink power – When Transmitters/Receivers are being powered by an Enova DGX DXLink board or DXLink power injector (using power via the DXLink line), to maintain the switcher’s power redundancy, we recommend that you:
 - Determine the power budget based on the Input/Output boards used and the quantity of powered endpoints (Transmitters/Receivers); see page 31.
 - Do not use the local DC power jack on the module (even if the local power adapter is turned off).

Power Issues with Enova DGX Systems

In an Enova DGX System when multiple endpoints (Transmitters/Receivers) cycle their power and the DXLink connection fails, check the following:

- Check to be sure that Transmitters/Receivers being powered by the local DC jack have power. (Local power always takes precedence.)
- Check to be sure that Transmitters/Receivers intended to be powered via the DXLink line do not have a DC jack plugged in (even if the local power adapter is turned off). This can cause inadvertent ground loops that can negatively affect DXLink power sensing circuits.

DXLink Connection Issues

One method for determining DXLink connection issues is to compare the pattern of the green and yellow DXLink LEDs on the Transmitter or Receiver against the tables below and then check the suggested items in the Troubleshooting column in the second table.

DXLink LED Patterns When Connection is Working as Expected

Check the status of the green and yellow DXLink LEDs (on rear of the modules – on lower edge of the Wallplate TX, or on the front of the Decor Wallplate TX – under customer provided standard decor style cover plate) against the following table to determine the status of the video signal over the DXLink line. All of the green / yellow patterns in this table indicate that the unit is working as expected given its current connections. If the LED pattern does not correspond to any of the green / yellow patterns in this table, check the table below.

LED Patterns – Working as Expected		
Green	Yellow	LED Pattern Description
Solid green	Solid yellow	The DXLink link is established and the video stream is passing HDCP protected content.
Solid green	Flashing yellow	The DXLink link is established and the video stream is passing unprotected content.
Solid green	Off	The DXLink link is established but no video content is being passed.
Off	Off	The DXLink link is not established and the accompanying DXLink unit is not powered on or is not connected.

DXLink LED Patterns When Connection is Failing

If the green / yellow DXLink LEDs on a unit do not have one of the normal patterns as stated in the table above, check the patterns in the table below and then check the items listed in the corresponding Troubleshooting column.

LED Patterns – Connection Failing				
Green	Yellow	LED Pattern Description	Problem Symptoms	Troubleshooting
Solid green	Sporadic flashing yellow	Poor DXLink signal quality	Video drops occasionally	Check for: <ul style="list-style-type: none"> • Cable installation problems • Alien crosstalk • If possible, identify the hostile cable
Fully illuminated, sporadic flashing green	Off	Bad DXLink signal quality		Check for: <ul style="list-style-type: none"> • Cable installation problems • Alien crosstalk • If possible, identify the hostile cable • Cable quality
Very dimly illuminated, rapid / sporadic flashing green	Off	Very bad DXLink signal quality	No video / audio / Ethernet	Check for: <ul style="list-style-type: none"> • Cable installation problems • Alien crosstalk • If possible, identify the hostile cable Cable quality

NOTE: For installations where the DXLink Twisted Pair device could lose connectivity for an extended period of time (greater than 5 minutes), the Offline Recovery Mechanism is an option that allows the device to detect its offline state and reconnect to a Master (see page 54).

Network Setup Issues

The instructions below can be used for first time setup of DXLink Modules on a network with no NetLinx Master (integrated or standalone).

NOTE: Before setting up the network, we recommend plugging all required Ethernet cables into the network before applying power to the DXLink Modules.

To set the IP, connection, and device parameters on a DXLink Module:

- Set the DIP switch on the DXLink Module to:
 - #1 and #3 Toggles – ON
 - #2 and #4 Toggles – OFF
- Attach the DXLink Module via its ICS LAN 10/100 port to the network or PC.
- Power up the DXLink Module.
The DXLink Module will get a DHCP address or default to 169.254.2.2 (or if the module is in Static IP Mode, the address will be 192.168.1.2).
- Establish a Telnet connection to the DXLink Module and set up the network parameters using the following three commands:
 - SET IP
 - SET CONNECTION
 - SET DEVICE
- Enter REBOOT.
- Reset the DIP switches to configure the DXLink Module for the specific type of system setup being used (see the “Common Scenarios” table on page 36).

NOTE: If you cannot locate the DXLink Module in the Online Tree, you can reset the factory default by holding the ID button during power up until the LEDs blink in unison and then releasing the ID button. This will revert the DXLink Module to DHCP mode. Start again at Step 1 above.

Technical Support

If this manual has not satisfactorily answered your questions regarding the DXLink Transmitters and Receivers or they are not operating as expected, please contact your AMX representative or technical support. Have the serial numbers for the modules ready. If the modules are connected to a switcher, locate the serial number for the switcher too.* We recommend recording the serial numbers in an easily accessible location.

AMX Contact Information

- 3000 Research Drive, Richardson, TX 75082
- 800.222.0193
- 469.624.8000
- Fax 469.624.7153
- Technical Support 800.932.6993
- www.amx.com

* When DXLink units are used in conjunction with an Enova DVX Solution, having Diagnostic Codes ready can be helpful for technical support in analyzing problems. (Press the Status button on the Enova DVX front panel and use the UP and DOWN navigational buttons to scroll through the menu options to the Diagnostic Codes.)

Appendix A - Upgrading the Firmware

Overview

The NetLinX Studio software application (available for free download from www.amx.com) provides the ability to transfer KIT files to NetLinX devices such as DXLink Transmitters and Receivers. The firmware on the Transmitters and Receivers can be upgraded in the field.

When a Transmitter and/or a Receiver are being used in conjunction with a switcher, the switcher's integrated Master is used for the KIT file transfer. FIG. 40 shows a Transmitter and a Receiver bound to the integrated Master in an Enova DGX 32 in NetLinX Studio's OnLine Tree. Follow the instructions on the top of page 88 to prepare for KIT file transfer and the instructions on page 90 for the actual transfer.

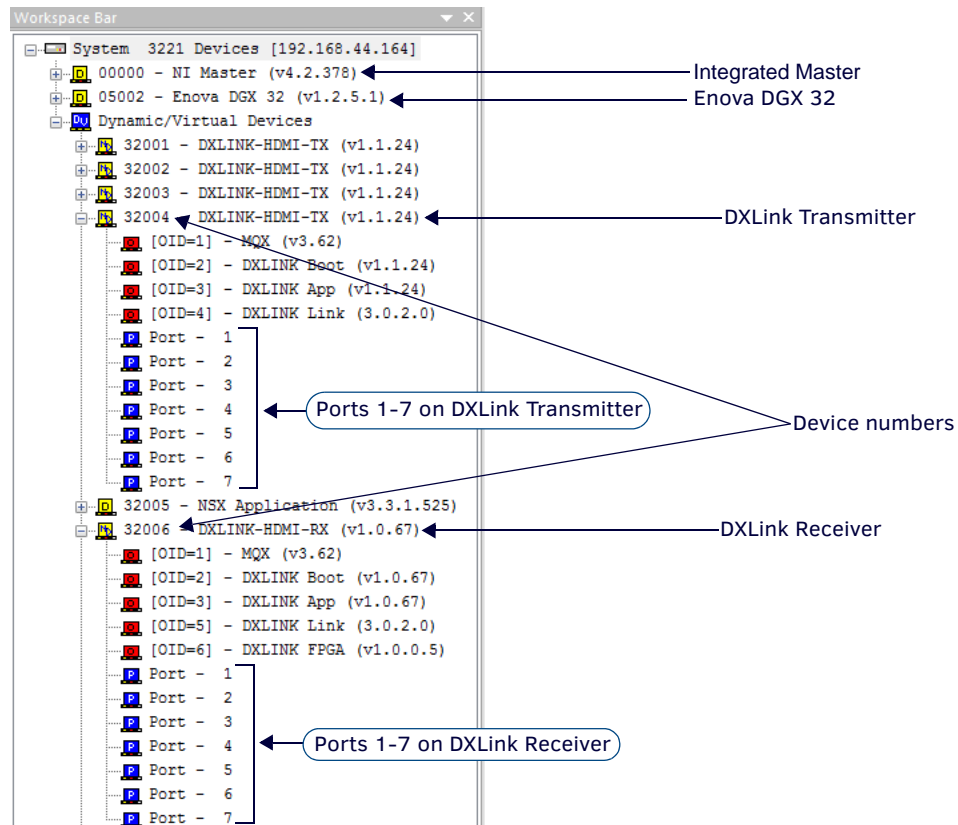
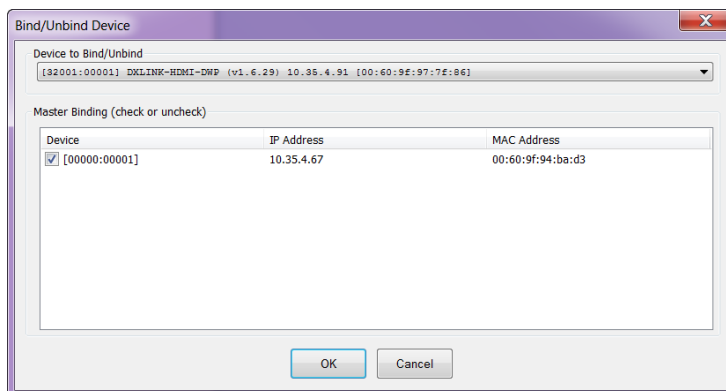

FIG. 40 NetLinX Studio – Integrated Master, Enova DGX 32, DXLink Transmitter, and DXLink Receiver

Preparing for KIT File Transfers

To prepare for KIT file transfers:

1. Check to be sure #3 Toggle on the bottom of the Transmitter or Receiver is set to ON.
2. Verify that you have the latest version of NetLinx Studio on your PC.
If the version is not the latest –
 - Use the Web Update option in NetLinx Studio's Help menu to obtain the latest version.
- Or
 - Go to www.amx.com and login as a Dealer to download the latest version.
3. Download the latest Firmware (KIT) file from www.amx.com on the DXLink Transmitter or Receiver product page to your PC. (Place KIT files on a local drive for speedy throughput.)
4. Verify the following:
 - a. Verify that an Ethernet/RJ-45 cable is connected from the switcher's integrated Master to the network (e.g., from the LAN 100/1000 port on an Enova DGX 32 to a LAN).
 - b. Verify that the target Transmitter or Receiver is connected via its DXLink connector to a DXLink Input or Output Board (respectively) on the switcher.
 - c. Verify that the switcher is powered on.
5. Launch NetLinx Studio and open the OnLine Tree.
6. Bind the target Transmitter or Receiver to the integrated Master: select and right-click the TX or RX; from the context sensitive menu, select Network Bind/Unbind Device (be sure the check box is selected); click OK.



7. Determine the Device Number assigned to the target Transmitter or Receiver when it was bound. For the Device Number location, see FIG. 40 on page 87. The Transmitter or Receiver is ready for the KIT file transfer.

Important Upgrade Information

CAUTION: *Upgrading the firmware is a serious action in that if the upgrade fails, it can leave the system completely non-operational.*

In the Event of Power Loss During an Upgrade

If power loss occurs *before* any firmware information has been transferred – when power is restored, the module will remain operational using the original firmware.

If power loss occurs *after* some of the firmware information has been transferred *but before* the transfer is complete – when power is restored, the module will time out and will not operate until a successful upgrade takes place.

CAUTION: *If the application signals a failure, you must immediately reboot the Transmitter or Receiver and attempt to upgrade the firmware again, as the module is in an unknown state and cannot be guaranteed to be operational.*

Firmware Versions

The following table contains firmware version information for the DXLink units.

DXLink Firmware Versions			
Applies to	Version #	Date	Differences
HDMI RX	1.0.80 and earlier	10/19/2012	<ul style="list-style-type: none"> A/V SEND_COMMANDs respond with STRINGS SEND_COMMANDs must be sent in uppercase
HDMI RX	1.0.80 or later	01/07/13	<ul style="list-style-type: none"> Supports PS-POE-AT-TC (FG423-84) and PDXL-2 (FG1090-170)
HDMI RX	1.3.X or later	03/07/13	<ul style="list-style-type: none"> A/V SEND_COMMANDs respond with COMMANDs SEND_COMMANDs are not case sensitive Updated VIDOUT_ASPECT_RATIO and VIDOUT_TESTPAT commands
HDMI TX	1.1.26 and earlier	09/24/2012	<ul style="list-style-type: none"> A/V SEND_COMMANDs respond with STRINGS SEND_COMMANDs must be sent in uppercase
Multi-Format TX / Multi-Format Wallplate TX	1.0.44	07/19/2012	<ul style="list-style-type: none"> A/V SEND_COMMANDs respond with COMMANDs SEND_COMMANDs are <i>not</i> case sensitive
Multi-Format TX / Multi-Format Wallplate TX	1.0.45	07/19/2012	<ul style="list-style-type: none"> Same as 1.0.44 Modified VGA EDID Added: VIDIN_PREF_EDID command for VGA input
HDMI TX / Multi-Format TX / Multi-Format Wallplate TX	1.2.X	10/19/2012	<ul style="list-style-type: none"> A/V SEND_COMMANDs respond with COMMANDs SEND_COMMANDs are <i>not</i> case sensitive Added: VIDIN_HDCP command for HDMI input
HDMI TX*	1.2.X	10/19/2012	<ul style="list-style-type: none"> When loading any 1.2.X version to an HDMI TX, you must send the FACTORYAV command to reset the AV registers (see page 80)
All Transmitters	1.2.40 or later	01/07/13	<ul style="list-style-type: none"> Supports PS-POE-AT-TC (FG423-84) and PDXL-2 (FG1090-170)
All Transmitters	1.4.7	06/12/13	<ul style="list-style-type: none"> Supports 3D, Deep Color, High Bit Rate Audio, and limited Telnet support of SEND_COMMANDs (no queries) Includes new VGA EDID AMX_0500_003 Supports custom VGA EDID using DGX Configuration Software and Program port Supports asynchronous notifications (NetLinx Studio and Telnet)
HDMI RX	1.5.8	06/12/13	<ul style="list-style-type: none"> Supports 3D, Deep Color, and limited Telnet support of SEND_COMMANDs (no queries) Includes v1.0.0.6 FPGA code Adds "show vs100 stats" Telnet command
All Transmitters	1.6.7	08/16/13	<ul style="list-style-type: none"> Supports USB functionality
HDMI RX	1.9.10	08/16/13	<ul style="list-style-type: none"> Supports USB functionality
All Transmitters	1.6.13	06/6/14	<ul style="list-style-type: none"> Enhanced immunity to garbage video sources Improved USB communication Resolved miscellaneous minor issues
HDMI RX	1.9.28	11/19/14	<ul style="list-style-type: none"> Added Offline Recovery Mechanism (Telnet command WD)
All Transmitters	1.6.29	11/19/14	<ul style="list-style-type: none"> Added Offline Recovery Mechanism (Telnet command WD)
All Transmitters	1.08.16	12/15/15	<ul style="list-style-type: none"> Supports connection to DXLink Input Boards running firmware version 1.4.0.10 or later Supports full Enova DGX 100 Series features
HDMI RX	1.13.18	12/15/15	<ul style="list-style-type: none"> Supports connection to DXLink Output Boards running firmware version 1.4.0.10 or later Supports full Enova DGX 100 Series features

NOTE: For additional details on version differences, see the applicable Readme file(s).

Transferring KIT Files

The system will be non-operational during the upgrade procedure below.

The *Firmware Transfers* tool in NetLinX Studio is used to map KIT files to DXLink Transmitters and Receivers. The instructions below assume that the preparations on the previous pages have been completed.

To send a KIT file to a DXLink Transmitter or Receiver:

1. In NetLinX Studio from the Tools menu, select “Firmware Transfers > Send to NetLinX Device” to open the Send to NetLinX Device dialog box.

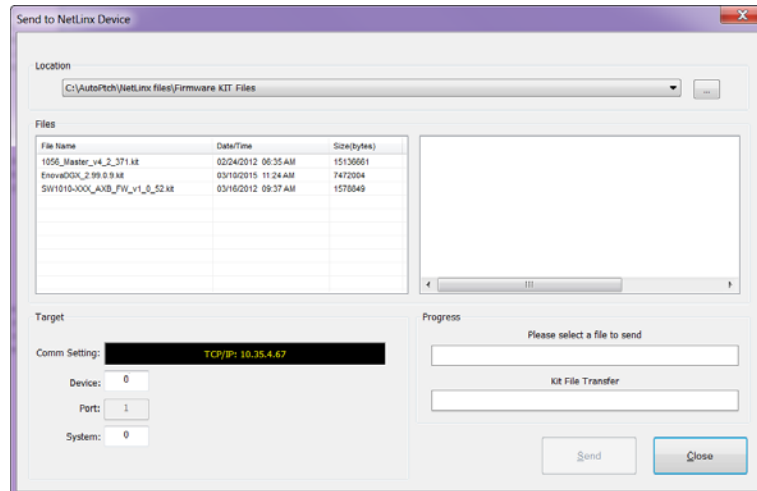

2. Click Browse (...) to navigate to the target directory. The selected directory path is displayed in the Location text box. KIT files in the target directory display under Files.
 3. Select the appropriate KIT file from the list.
 4. Enter the Device and System numbers (see FIG. 40 on page 87) for the target module in the Device and System text boxes.
 5. Review the File and Target Device information for accuracy before you send.
 6. Click Send to upgrade the firmware on the DXLink Transmitter or Receiver.
 - The Power LED blinks during the process for upgrading the firmware (this is normal).
 - The progress of the upgrade displays in the Upload Status field. Status is also indicated in the Status bar at the bottom.
 - The success of the upgrade or any errors that occur will be reported.*
- * If an incorrect file has been selected or if the upgrade has failed, the Power LED will briefly illuminate solid green then change to a slow blink. To recover (in either case), reboot the Transmitter or Receiver and browse to select the correct file and then re-send.
7. Close the window when the transfer is complete.
 8. When the process is complete, cycle power using the new image on the DXLink Module:
 - a. Unplug the desktop power supply from the AC power source and plug it back in.
 Or
 - b. If the power source is the switcher, unplug the RJ-45 connector from the DXLink port on the module and plug it back in.
 9. Wait 60 seconds and refresh the System OnLine Tree, and check to be sure the firmware version matches the version selected for the upgrade.

Reminders

When the file transfer is complete, remember to do the following:

- Set the #1 Toggle on the DXLink Module to OFF.
- If you set the PC to Static IP Mode for a Virtual NetLinX Master file transfer, return the setting to “Obtain an IP address automatically” (see page 101).

Appendix B - Telnet (Terminal) Commands

Establishing a Terminal Connection Via Telnet

Telnet terminal communication is accessed remotely via TCP/IP. The Transmitter or Receiver *must* have its own TCP/IP address for a Telnet connection. The connection can be started from the Windows taskbar (see below) or in NetLinX Studio (see the following page).

By default, a User Name and Password are not applied to the Telnet port (Port 23). Therefore, the port does not require login credentials.

Welcome Banner with and without Security Enabled:

- Without Telnet security enabled, a session will begin with a welcome banner similar to the following:
Welcome to DXLINK-HDMI-RX 0.0.106.0 Copyright AMX LLC 2011
>
- If Telnet security is enabled, user credentials are required:
Enter username: admin
Enter protected password: ****
Welcome to DXLINK-HDMI-RX 0.0.106.0 Copyright AMX LLC 2011
>

NOTE: When security is enabled, a user can retry logging in three times before being disconnected (for information on setting a username and password, see page 92).

IMPORTANT: If auto-setup mode is being used, Telnet is the only way to access some of the network settings. Also note that some network settings will disable the auto-setup feature (for auto-setup requirements, see the "Quick Reference Table – Modes for Handling Addressing/Networking" on page 20).

To establish a terminal connection via Telnet at the CMD prompt:

1. From your Windows Taskbar (at the far left), select Start > Run to open the Run dialog box.
2. Type `cmd` in the Open field.

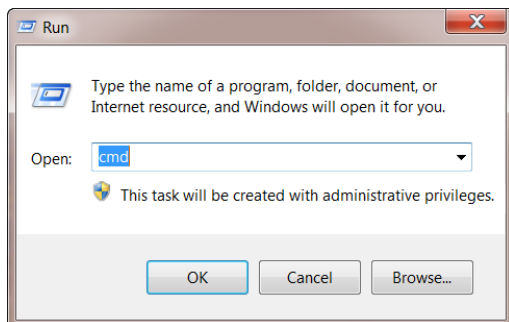

3. Click OK to open an instance of the Windows command interpreter (`cmd.exe`).
4. At the prompt (`>`), type `telnet` followed by a space and the Transmitter or Receiver's IP address.
Example:
`>telnet XXX.XXX.XXX.XXX`
A Telnet session opens for the Transmitter or Receiver and the welcome banner appears.*
5. At the prompt, type the Telnet command (see the table starting on page 93) and press Enter.

* If you are using Windows 7 and receive an error message, you may need to enable Telnet by completing the following: (1) go to Start / Control Panel / Programs and Features, (2) on the left, select "Turn Windows features on or off," (3) select the check-boxes Telnet Client and Telnet Server, and (4) click OK.

To establish a terminal connection via NetLinx Studio:

1. In the Online Tree, select the DXLink unit and right-click to access the short-cut menu.
2. Select Launch Telnet Window via NetLinx Studio.
The Telnet window opens and the welcome banner appears.

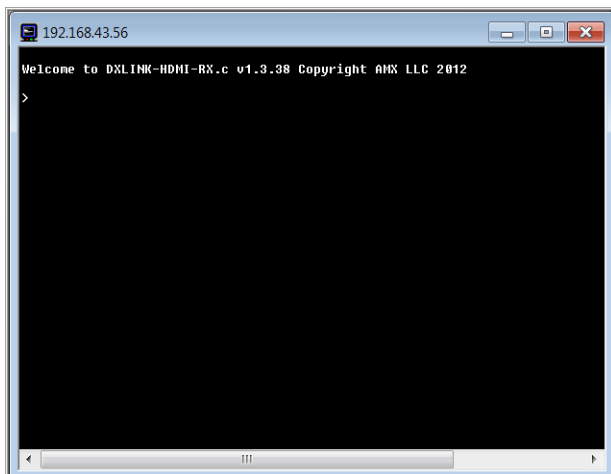

3. At the prompt (>), type the Telnet command and press Enter.

Telnet Username and Password

The following commands are used to set the Telnet username and password for a Telnet connection:

- Set Telnet Username
- Set Telnet Password

By default, both the username and password are blank (empty strings). Performing a factory reset on the device with the Pushbutton will return these values to that default. For details, see page 58.

- Username – Setting the Username will have no effect if the password remains blank (empty string). That is, defining the username alone will not result in Telnet prompting for a user login.
- Password – Setting the Password will cause Telnet to prompt for a user login, whether the username has been defined or not. If the username has been defined, this value must be entered.

However, since the password can be set independently of the username, it's possible to have a password defined, but the username still at its default (blank, empty string). In this case do not enter anything for the username when prompted. Simply press Enter, which will then present the password prompt. Here, the defined password must be entered in order to successfully open the Telnet session.

Additional Notes

- Both the Telnet username and password are case-sensitive.
- Three consecutive, unsuccessful attempts to log in to Telnet will cause the Telnet window to close.
- Re-launching Telnet will again present the login prompt, with a fresh “batch” of login attempts.
- If a Telnet login fails because of an incorrect username, an “Invalid Password” message will appear (as opposed to an “Invalid Username” message).
- The username and password are saved after reboot or power cycle.
- The username and password are deleted/removed after a factory reset.

NOTE: *Enova DGX 100 Series Switchers support Telnet commands and BCS commands over Telnet, while Enova DGX 8/16/32/64 Switchers support BCS tunneling access over TCP/IP. For information, see the applicable manual.*

Setting a Telnet Username and Password

To set a Telnet username and password:

1. Establish a terminal connection via Telnet (see page 91).
2. Type `Set Telnet Username`, and press Enter.
 - a. The program will prompt you to enter a new Telnet username; enter a username and press Enter.
 - b. The program will indicate that the username is being stored.
3. Type `Set Telnet Password`, and press Enter.
 - a. The program will prompt you to enter a password; press Enter twice to clear both the Telnet username and password.
 - b. Enter a password and press Enter.
 - c. The program will prompt you to re-enter the password; re-enter the password and press Enter. The program will indicate that the password is being stored.

Telnet Commands

The Telnet commands listed in the table below can be sent directly to the Transmitter or Receiver via a Telnet terminal session.

- The default Telnet port is 23. A value of 0 (zero) disables the Telnet server.
- Telnet is enabled by default.

In the terminal program, type `Help` or a question mark (?) and press Enter to access the Help Menu and display the terminal commands described in the table below.

Telnet Commands	
Command	Description
? or Help	Display the commands listed in this table.
DEVICE STATUS	<p>Displays device status of a specified device, port, system (<D:P:S>).</p> <p>NOTE: <i>Devices other than the DXLink Transmitter or Receiver itself will be ignored.</i></p> <p>Example:</p> <pre>>device status 32002:1:0 Device Status ----- Device 32002 AMX LLC,DXLINK-HDMI-RX, 0.0.106.0 contains 7 Ports Port 1 - Channels:255 Levels:8 MaxStringLen=64 Types=8 bit MaxCommandLen=64 Types=8 bit The following input channels are on:None The following output channels are on:None Level 1=0 Supported data types=UByte,UInt Level 2=0 Supported data types=UByte,UInt Level 3=0 Supported data types=UByte,UInt Level 4=0 Supported data types=UByte,UInt Level 5=0 Supported data types=UByte,UInt Level 6=0 Supported data types=UByte,UInt Level 7=0 Supported data types=UByte,UInt Level 8=0 Supported data types=UByte,UInt ></pre>
DIPSWITCH	<p>Displays the current value for each of the DIP switch's four toggles.</p> <p>Example:</p> <pre>>dipswitch Dipswitch - ON OFF OFF OFF ></pre>
EXIT	Exit the Telnet session
FACTORYFWIMAGE	Resets unit to factory firmware image and reboots DXLink Transmitter or Receiver.

Telnet Commands	
GET CONFIG	<p>Displays the current connection settings.</p> <p>Example:</p> <pre>>get config Device number: 7010 Connection Settings ----- Mode: NDP System Number: 2155 Master IP/URL: 192.168.43.83 Master Port: 1319 Username: Password: IP Settings ----- HostName: DXL-RX-36d0110 Type: DHCP IP Address: 192.168.43.63 Subnet Mask: 255.255.255.0 Gateway IP: 192.168.43.2 MAC Address: 00:60:9f:99:26:f1 DHCP Server : 192.168.43.2 Lease Origin : THU 01/09/2031 12:59:02 Lease Duration : SUN 01/12/2031 12:59:02 (259200 sec) Lease Renew (T1): SAT 01/11/2031 00:59:02 (129600 sec) Lease Rebind (T2): SUN 01/12/2031 03:59:02 (226800 sec) DNS Servers ----- Domain suffix: amx.internal Entry 1: 192.168.40.7 Entry 2: 192.168.40.8</pre> <p>NOTE: <i>The system number and IP addressing information displayed is reflective of actual operating values, not stored parameters.</i></p>
GET CONNECTION	<p>Shows the Master connection information.</p> <p>Example:</p> <pre>>get connection Connection Settings ----- Mode: UDP URL System Number: 1 Master IP/URL: 192.168.44.53 Master Port: 1319 Username: Password:</pre>
GET DEVICE	<p>Displays the device number.</p>
GET DNS	<p>Gets the list of DNS entries.</p> <p>Example:</p> <pre>>get dns DNS Servers ----- Domain suffix: amx.internal Entry 1: 192.168.40.7 Entry 2: 192.168.40.8</pre> <p>NOTE: <i>When the DXLink Transmitter or Receiver is in DHCP Mode, these are active values, NOT the stored values that only apply to Static IP Mode.</i></p>
GET ETHERNET MODE	<p>Displays the current LAN configuration setting.</p> <p>Settings are <i>either</i> "auto" in which the LAN driver will discover its settings based on the network it is connected to <i>or</i> <speed> and <duplex> where speed and duplex are either 100 full or 10 half.</p> <p>Example:</p> <pre>>GET ETHERNET MODE Ethernet mode is auto.</pre> <p>NOTE: <i>See SET ETHERNET MODE.</i></p>
GET FRIENDLY	<p>Displays the device's friendly name (for NDP).</p>

Telnet Commands	
GET IP	<p>Displays the IP configuration of a device. The device displays its D:P:S, Host Name, Type (<i>DHCP</i> or <i>Static</i>), IP Address, Subnet Mask, Gateway IP, and MAC Address.</p> <p>Example:</p> <pre>>GET IP HostName DXL-RX-36d0110 Type DHCP IP Address 192.168.43.63 Subnet Mask 255.255.255.0 Gateway IP 192.168.43.2 MAC Address 00:60:9f:99:26:f1</pre> <p>[[also displays "Lease" details; see example for <i>GET CONFIG</i> command]]</p>
GET LOCATION	Displays the location parameter for NDP, which is set by using the <i>SET LOCATION</i> command.
GET SN	Returns the device's serial number.
LED [ON OFF]	Enables/Disables LEDs for identification.
MSG [ON OFF]	<p>Enables/Disables extended diagnostic messages.</p> <ul style="list-style-type: none"> MSG ON [error warning info debug] sets the terminal program to display log messages generated by the Master. The level of log printed to the terminal window depends both on the level used when sending the message and the output level selected with "msg on." For example if log output is enabled via "msg on warning" then logs produced at levels AMX_ERROR and AMX_WARNING will be displayed, but not logs produced at levels AMX_INFO or AMX_DEBUG. The order of severity from highest to lowest is ERROR, WARNING, INFO, DEBUG. If no severity is supplied with "msg on," the default setting is WARNING. MSG OFF disables the display. <p>Example:</p> <pre>> MSG ON Extended diagnostic information messages turned on. > MSG OFF Extended diagnostic information messages turned off.</pre>
NDP UNBIND	Clears the NDP binding to a Master (requires reboot to take effect).
PING [ADDRESS]	<p>Pings an address (IP or URL), to test network connectivity to and confirms the presence of another networked device. The syntax matches the PING application in Windows or Linux.</p> <p>Example:</p> <pre>>ping 192.168.29.209 192.168.29.209 is alive.</pre>
REBOOT	<p>Reboots the DXLink Transmitter or Receiver.</p> <p>Example:</p> <pre>>REBOOT Rebooting...</pre>
RENEW DHCP	<p>Renews / releases the current DHCP lease for the DXLink Transmitter or Receiver.</p> <p>NOTE: <i>Because sending this command can result in the unit acquiring a new DHCP address and the functionality of the endpoints is dependent on the mated IP addresses of the TX (host) and RX (device), the USB connection may need to be re-established.</i></p> <p>Example:</p> <pre>>RENEW DHCP</pre>
RESET FACTORY	<p>Resets the device's stored parameters to factory default state including removal of all security settings, resetting to DHCP. This command will cause an automatic reboot.</p> <p>NOTE: <i>This command does not reset the device to the factory software image.</i></p>
SEND_COMMAND [D:P:S,"command"]	<p>Sends the specified SEND_COMMAND (does not work with queries) to the current DXLink Transmitter or Receiver.</p> <p>NOTE: <i>Commands cannot be forwarded to other D:P:S. Asynchronous notifications are available for the Transmitters via Telnet (and NetLinX Studio).</i></p> <p>Example:</p> <pre>send_command 6501:1:0, 'VIDIN_AUTO_SELECT-ENABLE'</pre>
SEND_STRING [D:P:S,"string"]	<p>Sends the specified SEND_STRING to the current DXLink Transmitter or Receiver or connected Master.</p> <p>NOTE: <i>Commands cannot be forwarded to other D:P:S. Asynchronous notifications are available for the Transmitters via Telnet (and NetLinX Studio).</i></p> <p>Example:</p> <pre>send_string 32001:1:1, "27,18,0"</pre>

Telnet Commands	
SET CONNECTION	<p>Sets the Master connection settings interactively, allowing the user to specify the mode (for descriptions of various connection modes, see page 20).</p> <ul style="list-style-type: none"> • If the mode is TCP or UDP, the Master URL and port number can be specified as well. • If Auto is selected, the System number can be specified. • After all data is entered, if the parameters have changed, the DXLink Transmitter or Receiver will disconnect from the Master, and begin trying to connect with the new settings. <p>NOTE: <i>These changes do not require a reboot to take effect.</i></p>
SET DEVICE	<p>Sets the device number, and stores it in non-volatile memory.</p> <p>Syntax: SET DEVICE <num></p> <p>The valid range of device numbers is 0 to 31999.</p> <ul style="list-style-type: none"> • If the user enters a number outside that range, then no change will be made and the DXLink Transmitter or Receiver will issue an error message. • A Device Number of '0' means that the DXLink Transmitter or Receiver will accept the auto-assigned device number from the Master. • If the new device number is different from the old device number, the DXLink Transmitter or Receiver will disconnect from the Master, and begin trying to connect with the new settings. <p>NOTE: <i>These changes do not require a reboot to take effect.</i></p>
SET DNS	<p>Sets the DNS configuration of the DXLink Transmitter or Receiver, only as applied to Static IP Mode (DNS settings in DHCP Mode are received from the DHCP server).</p> <p>Syntax: SET DNS</p> <p>This command prompts you to enter a Domain Name, DNS IP #1, DNS IP #2, and DNS IP #3.</p> <ul style="list-style-type: none"> • Enter Y (yes) to approve/store the information in the Master. • Enter N (no) cancels the operation. <p>NOTE: <i>The device must be rebooted to enable new settings.</i></p> <p>Example:</p> <pre>>SET DNS -- Enter New Values or just hit Enter to keep current settings -- Enter Domain Suffix: amx.com Enter DNS Entry 1 : 192.168.20.5 Enter DNS Entry 2 : 12.18.110.8 Enter DNS Entry 3 : 12.18.110.7 You have entered: Domain Name: amx.com DNS Entry 1: 192.168.20.5 DNS Entry 2: 12.18.110.8 DNS Entry 3: 12.18.110.7 Is this correct? Type Y or N and Enter -> Y Settings written. Device must be rebooted to enable new settings</pre>
SET ETHERNET MODE	<p>This command sets the current LAN configuration settings per new mode.</p> <p>Syntax: SET ETHERNET MODE <newmode></p> <p>Values for <i>newmode</i> are: auto</p> <p>Or 100 full or 10 half</p> <p>NOTE: <i>This command requires a reboot to enable new settings.</i></p> <p>Examples: set ethernet mode auto set ethernet mode 100 full</p> <p>NOTE: <i>See GET ETHERNET MODE.</i></p>
SET FRIENDLY	<p>Set the device's friendly name for NDP to <name>.</p> <p>Syntax: SET FRIENDLY <name></p> <ul style="list-style-type: none"> • Maximum length = 25 characters. If the name entered exceeds 25 characters, it will be truncated. • The value is stored in non-volatile memory. • If no value specified, an automatic name consisting of AMX, the product name, and serial number will be used. <p>NOTE: <i>This command requires a reboot to enable new settings.</i></p>

Telnet Commands	
SET IP	<p>Sets the IP configuration of a specified device. Enter a Host Name, Type (<i>DHCP</i> or <i>Fixed</i>), IP Address, Subnet Mask, and Gateway IP Address.</p> <p>IMPORTANT: <i>Host Names may only contain ASCII letters "a" through "z" (not case-sensitive), digits "0" through "9", and the hyphen ("-").</i></p> <p>NOTE: <i>DHCP implies "DHCP with link-local fallback".</i></p> <p>NOTE: <i>For NetLinx Masters, the Host Name can only consist of alphanumeric characters.</i></p> <ul style="list-style-type: none"> • Enter Y (yes) to approve/store the information on the Master. • Enter N (no) to cancel the operation. <p>NOTE: <i>This command requires a reboot to enable new settings.</i></p> <p>Example:</p> <pre>>SET IP --- Enter New Values or just hit Enter to keep current settings --- Enter Host Name: DXL-RX-36d0110 Enter IP type. Type D for DHCP or S for Static IP and then Enter: DHCP You have entered: Host Name DXL-RX-36d0110 Type DHCP Is this correct? Type Y or N and Enter -> y Settings written. Device must be rebooted to enable new settings.</pre> <p>NOTE: <i>DXLink Modules can also be set to Static IP or DHCP Mode via the front panel ID Pushbutton.</i></p>
SET LOCATION	<p>Sets the location parameter for NDP.</p> <p>Syntax:</p> <pre>SET LOCATION <location></pre> <ul style="list-style-type: none"> • Maximum length = 25 characters. If the name entered exceeds 25 characters, it will be truncated. <p>NOTE: <i>This command requires a reboot to enable new settings.</i></p>
SET TELNET PORT	<p>Sets the device's IP port listened to for Telnet connections.</p> <p>Example:</p> <pre>>SET TELNET PORT Current telnet port number = 23 Enter new telnet port number (Usually 23)(0 = disable Telnet): Once you enter a value and press the Enter key, you get the following message: Setting telnet port number to 23 New telnet port number set, reboot the device for the change to take effect.</pre> <p>NOTE: <i>This command requires a reboot to enable new settings.</i></p> <p>IMPORTANT: <i>If you set the Telnet port to "0" to disable it, you will need to reset it with a SEND_COMMAND in NetLinx Studio (see page 79).</i></p>
SET TELNET USERNAME	<p>NOTE: <i>This command is supported but is not presently in the Help file list of commands.</i></p> <p>Sets the Username for a secure Telnet session.</p> <ul style="list-style-type: none"> • Default = blank (no username required) • For details, see page 92.
SET TELNET PASSWORD	<p>NOTE: <i>This command is supported but is not presently in the Help file list of commands.</i></p> <p>Sets the Password for a secure Telnet session.</p> <ul style="list-style-type: none"> • Default = blank (no password required) • For details, see page 92.
SHOW CONNECTION LOG	<p>Shows the Master connection log for the device.</p>
SHOW CONNECTION STATS	<p>Shows the connection statistics for the device.</p> <p>Output similar to the following example:</p> <pre>>show connection stats Connection Statistics Total Last 15 Minutes ===== ICSP Messages: 10039 received 333 received 10038 transmitted 333 transmitted Blink Messages: 5014 received 166 received IP Statistics: RX packets:29298 errors:0 discarded:0 TX packets:15286 errors:0 discarded:0</pre>

Telnet Commands	
SHOW LOG	Displays the message log. Syntax: SHOW LOG <start> Specifies the message number to start displaying. SHOW LOG <all> OR SHOW LOG Displays all messages.
SHOW VS100 STATS	Displays DXLink transport information (MSE values, length, etc.).
WD	Queries/enables/disables the Offline Recovery Mechanism (for complete information see page 54). IMPORTANT: A reboot is required after setting the recovery mechanism before the new setting takes effect. Syntax: WD Queries the module for the setting of the Offline Recovery Mechanism. WD ON Sets the recovery mechanism to ON . WD OFF Sets the recovery mechanism to OFF (default).

Master Connection Modes

The mode of communication used for connection to the Master is specified via the SET CONNECTION Telnet command (see page 96).

Connection mode setting options are AUTO, TCP URL, UDP URL, or NDP (default) as described:

- **AUTO** – This mode utilizes TCP communication. It looks for a matching System Number and attempts to come online with the first Master it sees with that System Number.
- **TCP URL** – TCP; the Master is specified via URL.
- **UDP URL** – UDP; the Master is specified via URL.
- **NDP** – UDP; this mode utilizes the NDP binding process to assign the DXLink Module (the physical device) to a Master (or Virtual Master) via NetLinx Studio. Once bound, communications are conducted via UDP.

NOTE: In URL modes, the Master can use either an IP address or a DNS name.

Guidelines

UDP mode is recommended for the following types of installations:

- Small-to-medium residential and corporate installations on a single subnet
- Segmented control network installations (control network is a separate switching domain and subnet from other network equipment)
- Installations with the total number of NetLinx / ICSNET devices on a single Master exceeding 128

TCP mode is recommended for installations where (a) the switching domain of the network is subject to “bursty” traffic or heavy streaming activity (>20 Mbps consumption by streaming) and where (b) the total number of NetLinx / ICSNET devices on a single Master is less than 128.

TCP vs. UDP

- TCP – Protocol has a built-in retry mechanism.
- UDP – Protocol does not have a built-in retry mechanism, but consumes fewer resources on the Master. AMX’s UDP implementation of NetLinx employs a retry mechanism to provide the reliability of TCP with the resource efficiency of UDP.

URL vs. NDP vs. Auto

Determining which connection method to use for Master Connection Mode is essentially a matter of deciding what information the device should use to identify the correct Master to connect to.

The default mode is NDP; the mode can be changed via the `SET CONNECTION` Telnet command (see page 96).

- **URL** – The device connects to the Master with the specified URL. The device must be configured with the URL of a specific Master via the `SET CONNECTION` Telnet command (see page 96).
- **NDP** – The device connects to the Master it's been bound to, which is based on the Master's MAC address. The binding is configured via NetLinx Studio. Once bound, the device must be unbound using either NetLinx Studio or the Telnet `NDP UNBIND` command before being re-bound to a different Master. Alternatively, NDP devices can be bound/unbound via options on the Master's Web Configuration pages (System > Manage NetLinx). For details, refer to the *WebConsole & Programming Guide – NX-Series Controllers* (System - Manage NetLinx section).
- **Auto** – The device connects to the first Master it finds with the specified System Number. The device must be configured with the desired system number via the `SET CONNECTION` Telnet command (see page 96).

Use of this method requires that only one Master has any particular system number and is visible to the subnet. If this is the case, then Auto is the simplest choice. However, with Auto, you are not hard-bound to a particular Master. Therefore, if at some point in the future, another Master is configured with the same system number, the result is that the DXLink Module could show up on that other Master.

Notes on Specific Telnet Clients

Telnet and terminal clients exhibit different behaviors in some situations. This section states some of the known anomalies.

Windows Client Programs

Anomalies occur when using a Windows® client if you are not typing standard ASCII characters (i.e., using the keypad and the Alt key to enter decimal codes). Most programs will allow you to enter specific decimal codes by holding Alt and using keypad numbers.

Example

For example, hold Alt, hit the keypad 1, then hit keypad 0, then release Alt. The standard line feed code is entered (decimal 10). Windows will perform an ANSI to OEM conversion on some codes entered this way because of the way Windows handles languages and code pages.

The following codes are known to be altered, but others may be affected depending on the computer's setup.

- Characters **15, 21, 22**, and **any characters above 127**.

This affects both Windows Telnet and Terminal programs.

Linux Telnet Client

The Linux Telnet client has three anomalies that are known at this time:

- A null (`\00`) character is sent after a carriage return.
- If an "Alt 255" is entered, two of the "255" characters are sent (per the Telnet RAFT).
- If the code to return to Command mode is entered (Alt 29 which is CTRL+]), the character is not sent, but the Telnet Command Mode is entered.

Appendix C - Virtual NetLinx Master

Overview Virtual NetLinx Master (Masterless)

A Virtual NetLinx Master can be created using your PC, which allows NetLinx Studio to facilitate direct file transfers to a DXLink Transmitter or Receiver when a Master is not available.

Four basic procedures must be completed for Virtual Master file transfers:

- Set the PC to a static IP address (see below).
- Create a Virtual Master in NetLinx Studio (see page 101).
- Prepare the DXLink Transmitter or Receiver by placing it in Static IP Mode, assigning a device ID, and setting the connection type to TCP (see page 102).
- Transfer the files using a Virtual Master TCP/IP connection (for IRL file transfers, see page 60; for Firmware file transfers, see page 87).

Setting PC to Static IP Address

IMPORTANT: When you change the PC's settings to a static IP address, the address must be in the same subnet as the DXLink unit (the default static IP address for DXLink Transmitters and Receivers is 192.168.1.2).

Important Information for PCs with Multiple Network Access Points

If the PC has more than one point of network access (multiple NIC cards or wireless networking), check to see if one of the connections uses an IP address of 192.168.1.x before proceeding.

To check for multiple networks:

1. Open the PC's Start menu (at the lower left of the desktop on the Taskbar) and select Run.
2. Enter cmd and click OK.
3. At the prompt, enter `ipconfig /all` and press the Enter key.
4. Check the IP Addresses under Connection.

If the PC or Laptop is currently using a connection with an IP address of 192.168.1.x, you will need to disconnect the connection.

To disconnect a network connection:

1. **Modem:** From the Start menu on the desktop taskbar, select Settings \ Network Connections.
Wireless: From the Start menu on the desktop taskbar, select Control Panel \ Network and Internet \ Manage Wireless Networks.
2. Right-click the network connection and select Disable.

NOTE: The following procedure uses the most current version of Windows available at the time of publication.

To set a PC to Static IP Mode:

1. From the Start menu on the desktop taskbar, select Control Panel / Network Sharing Center.
2. Click "Change adapter settings" (top left).
3. Right-click on Local Area Connection and select Properties.
The Local Area Connection Properties dialog box opens.

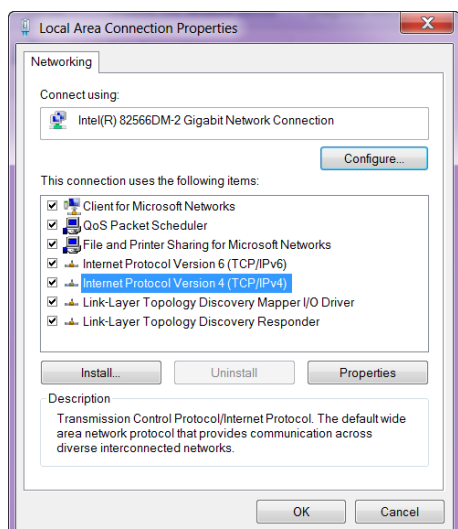

- From the list of “This connection uses the following items” (see previous step), highlight Internet Protocol Version 4 (TCP/IPv4) and click Properties.

The Internet Protocol Version 4 (TCP/IPv4) Properties dialog box opens.

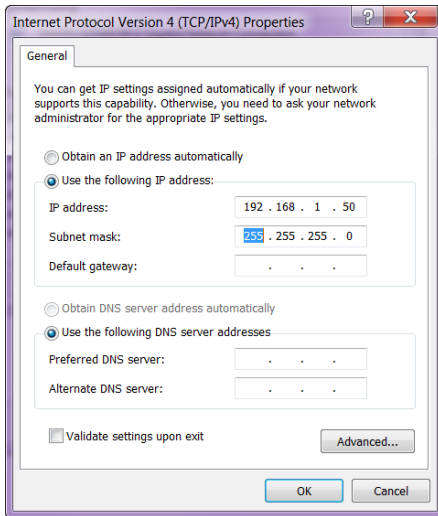

- Select “Use the following IP address” and enter 192.168.1.50 (or the IP range of the Enova DGX or Enova DVX).
- Press the Tab key on your keyboard to auto-fill the Subnet mask field.
- Click OK and click Close.

IMPORTANT: When finished using the PC as a Virtual Master, change the setting in the dialog box shown in Step 4 back to “Obtain an IP address automatically.”

Creating a Virtual Master

To create a Virtual Master in NetLinX Studio:

- Open NetLinX Studio.
- From the Settings menu, select Workplace Communication Settings.

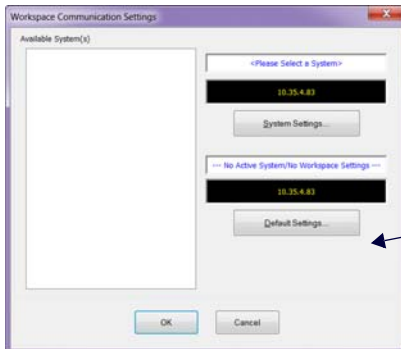

Click to open the Communication Settings dialog box

- Click the Default Settings button. The Communication Settings dialog box opens.

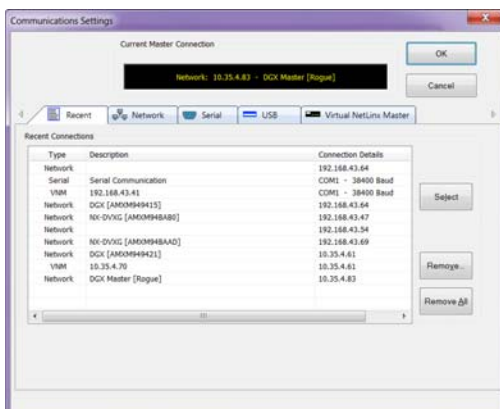

4. Select the Virtual NetLinx Master tab.

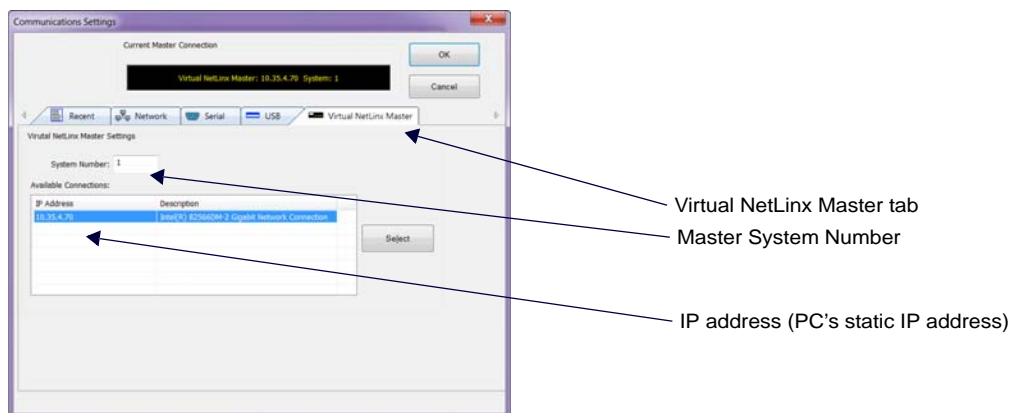

5. Under Virtual NetLinx Master Options:
 - a. Optional – Change the Master System Number (default = 1; range = 1 to 65535).
 - b. Select the desired IP Address in the Available Connections list (this will be the static IP address that the PC was set to in the previous instructions).
6. Click Select.
7. Click OK to save the changes and close the dialog box.
The Virtual Master displays in the NetLinx Studio's OnLine Tree.

IMPORTANT: When transferring files via a Virtual Master, a direct connection must be made between the module and the PC via the module's ICS LAN 10/100 port.

Preparing a DXLink Unit to Work with a Virtual Master

Preparing the DXLink Transmitter or Receiver to work with a Virtual Master requires placing the unit in Static IP Mode, assigning it a device ID, and setting the connection type to TCP.

NOTE: When using the first set of instructions below, only one DXLink Module can be connected to the Virtual Master at a time because the static IP address is the same for all modules.

To place a DXLink Module in Static IP Mode:

1. Connect the DXLink unit via its ICS LAN 10/100 port to the PC acting as a Virtual Master.
2. Set the DIP Switch's #1 and #3 Toggles to ON.
3. Apply power to the DXLink Module.
4. Once the DXLink Module has booted up (the Power LED on the front of the module turns a constant green, indicating a ready state), press and hold the ID Pushbutton for at least 10 seconds.
5. The NetLinx LEDs toggle back and forth during this time and then blink faster in unison; release when the faster blink starts.
 - When the Pushbutton is released, the DXLink Module toggles either from static to dynamic (DHCP) IP addressing or vice versa and remains in that mode until the ID Pushbutton is used to set it again.
 - The DXLink Module automatically reboots to complete the process.

To assign a device ID and set the connection type:

1. From the Tools menu in NetLinx Studio, select Telnet Session.
The TELNET Communication Selection dialog box opens.

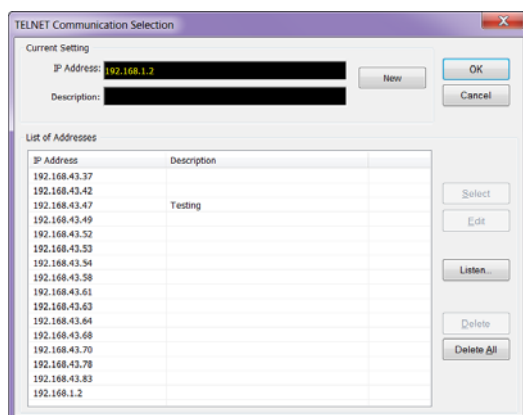

2. Click the New button.
The New Telnet Address dialog box opens.

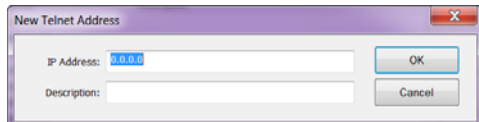

3. Enter the default static IP address for the DXLink unit: 192.168.1.2 and click OK.
4. Select the new address in the List of Addresses.
5. Click the Select button and click OK.
6. A Telnet session opens.
7. At the prompt (>), type `SET DEVICE <num>` and press Enter.
 - For the variable <num>, the valid range of device numbers is 0 to 31999.
 - Setting a device number does not require a reboot to take effect.
8. At the prompt, type `SET CONNECTION` and press Enter.
9. Specify TCP for the connection and the PC's static IP address for the Master.
The Transmitter or Receiver displays under the Virtual Master and is now ready for file transfers.

NOTE: The process can be repeated for additional DXLink Transmitters and Receivers.

File transfers via a Virtual Master:

- IRL file transfers, see page 60
- Firmware file transfers, see page 87

IMPORTANT: Once you have finished using the Virtual Master – If you disabled a network connection before setting the PC's static IP address, be sure to disable the Virtual Master's network connection and enable the original connection.

Appendix D – Cable Details and Pinout Info

Overview

The DXLink units; DX-TX, HDMI TX, Wallplate TX, Decor Wallplate TX, and DX-RX; all have connectors for HDMI. DXLink Transmitters (except the HDMI TX) have an additional port for HD-15 connectors.

The following table shows the video connections available on each of the DXLink units.

Connection Type by DXLink Unit					
Connection	DXLink Units				
	DX-TX	HDMI TX	Wallplate TX	Decor Wallplate TX	DX-RX
HDMI	•	•	•	•	•
HD-15	•		•	•	

IMPORTANT: System configurations will vary, necessitating different cable requirements for each system. Cables not available through AMX should come from a trusted cable supplier.

NOTE: When cabling video through either the HDMI port or HD-15 port, installers should be aware of how cabling will affect audio signals. For information on audio precedence, see “Audio Type Precedence” on page 41.

HDMI Connector Cable Pinout

HDMI connectors are found on all DXLink units. These connectors are used to pass HDMI or DVI-D signals (using a DVI-to-HDMI cable adapter) from a source device to a DXLink Transmitter or from a DXLink Receiver to a destination device. The following table provides cable pinout details for HDMI connections.

HDMI Connector Cable Pinout	
Pin	Signal Assignment
1	TMDS Data 2+
2	TMDS Data 2 Shield
3	TMDS Data 2-
4	TMDS Data 1+
5	TMDS Data 1 Shield
6	TMDS Data 1-
7	TMDS Data 0+
8	TMDS Data 0 Shield
9	TMDS Data 0-
10	TMDS Clock+
11	TMDS Clock Shield
12	TMDS Clock-
13	CEC
14	Utility
15	SCL
16	SDA
17	DDC/CEC Ground
18	+5 V Power (max. 55 mA)
19	Hot Plug Detect

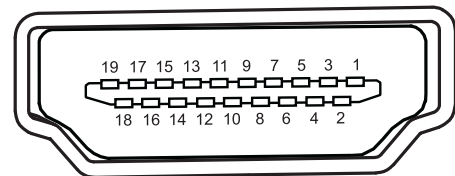

NOTE: DVI-to-HDMI cables may be required for particular system needs (see page 106).

FIG. 41 HDMI pinout information and connector pins

HD-15 Connector Cable Pinout

HD-15 connectors are found on the DX-TX, Wallplate TX, and Decor Wallplate TX. These connectors are used to accept a variety of analog video signals from a source device. The following table provides cable pinout details for HD-15 connections for VGA, VGA-RGBS, VGA-RGB, component, S-Video, and composite.

HD-15 Connector Cable Pinout						
Input Pin #	VGA-RGBHV	VGA-RGBS	VGA-RGB	Component	S-Video	Composite
1	Red	Red	Red	Pr	n/c	n/c
2	Green	Green	Green+Sync	Y	Y	Composite
3	Blue	Blue	Blue	Pb	C	n/c
4	n/c	n/c	n/c	n/c	n/c	n/c
5	GND	GND	GND	n/c	n/c	n/c
6	GND - Red	GND - Red	GND - Red	GND - Pr	n/c	n/c
7	GND - Green	GND - Green	GND - Green	GND - Y	GND - Y	GND - Composite
8	GND - Blue	GND - Blue	GND - Blue	GND - Pb	GND - C	n/c
9	+5 V DDC	+5 V DDC	+5 V DDC	n/c	n/c	n/c
10	GND	GND	GND	n/c	n/c	n/c
11	n/c	n/c	n/c	n/c	n/c	n/c
12	DDC_SDA	DDC_SDA	DDC_SDA	n/c	n/c	n/c
13	H Sync	S	n/c	n/c	n/c	n/c
14	V Sync	n/c	n/c	n/c	n/c	n/c
15	DDC_SCL	DDC_SCL	DDC_SCL	n/c	n/c	n/c

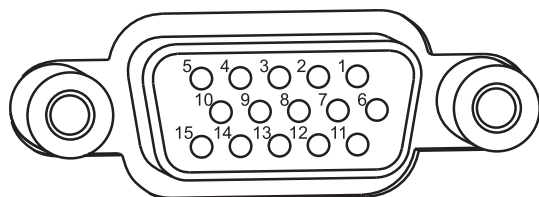

FIG. 42 HD-15 Connector pins

DVI Pinout for DVI-to-HDMI Cable Adapter

The pinout in FIG. 43 is for DVI-to-HDMI cable adapters which can be used with the modules when a DVI-I signal is required.

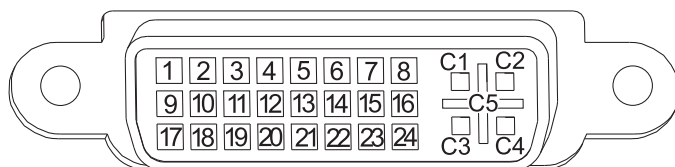

FIG. 43 DVI pinout for DVI-to-HDMI cable adapter

DVI Connector Pinout			
DVI Input Pin #	Signal Name	DVI Output Pin	Signal Name
1	Data 2-	1	Data 2-
2	Data 2+	2	Data 2+
3	Gnd	3	Gnd
4	n/c	4	n/c
5	n/c	5	n/c
6	DDC-CLK	6	DDC-CLK
7	DDC-Data	7	DDC-Data
8	n/c	8	n/c
9	Data 1-	9	Data 1-
10	Data 1+	10	Data 1+
11	Gnd	11	Gnd
12	n/c	12	n/c
13	n/c	13	n/c
14	+5 VDC in	14	+5 VDC out*
15	Gnd	15	Gnd
16	Hot-Detect	16	Hot-Detect
17	Data 0-	17	Data 0-
18	Data 0+	18	Data 0+
19	Gnd	19	Gnd
20	n/c	20	n/c
21	n/c	21	n/c
22	Gnd	22	Gnd
23	CLK+	23	CLK+
24	CLK-	24	CLK-
C1	n/c	C1	n/c
C2	n/c	C2	n/c
C3	n/c	C3	n/c
C4	n/c	C4	n/c
C5	n/c	C5	n/c

*The +5 VDC on output pin 14 supplies a maximum of 55 mA.

Appendix E - Supported Input Resolutions

Available Pixel Display and Refresh Rate

The available pixel display and refresh rates for the input devices connected to the DXLink Transmitters are listed in this appendix.

The resolutions in the following tables are supported on the DXLink Transmitters and can be set using a SEND_COMMAND. The horizontal/vertical/refresh information from the Resolution Name (in the first column) can be entered in a SEND_COMMAND (VIDIN_PREF_EDID) to specify the preferred resolution for the VGA video input for the Transmitters. For complete command information, see page 70.

DVI, HDMI, and VGA Supported Input Resolution

DVI, HDMI, and VGA Supported Resolutions							
Resolution Name	Horizontal Active Pixels	Vertical Active Pixels	Refresh (Hz)	HDMI and DVI Support	VGA Support	Comments	Video Standard
640x400,85	640	400	85	✓	✓		VESA DMT
640x480,60	640	480	60	✓	✓		VESA DMT
640x480,72	640	480	72	✓	✓		VESA DMT
640x480,75	640	480	75	✓	✓		VESA DMT
640x480,85	640	480	85	✓	✓		VESA DMT
720x400,85	720	400	85	✓	✓		VESA DMT
720x480p,60	720	480	60	✓	✓	480p	CEA 861
720x480p,120	720	480	120	✓	✓	480p	CEA 861
720x480p,240	720	480	240	✓	✓	480p	CEA 861
720x576p,50	720	576	50	✓	✓	576p	CEA 861
720x576p,100	720	576	100	✓	✓	576p	CEA 861
720x576p,200	720	576	200	✓	✓	576p	CEA 861
800x600,56	800	600	56	✓	✓		VESA DMT
800x600,60	800	600	60	✓	✓		VESA DMT
800x600,72	800	600	72	✓	✓		VESA DMT
800x600,75	800	600	75	✓	✓		VESA DMT
800x600,85	800	600	85	✓	✓		VESA DMT
848x480,60	848	480	60	✓	✓		VESA DMT
848x480,75	848	480	75	✓	✓		VESA CVT
848x480,85	848	480	85	✓	✓		VESA CVT
1024x640,60	1024	640	60	✓	✓		VESA CVT
1024x768,60	1024	768	60	✓	✓		VESA DMT
1024x768,70	1024	768	70	✓	✓		VESA DMT
1024x768,75	1024	768	75	✓	✓		VESA DMT
1024x768,85	1024	768	85	✓	✓		VESA DMT
1152x864,75	1152	864	75	✓	✓		VESA DMT

DVI, HDMI, and VGA Supported Resolutions (continued)							
Resolution Name	Horizontal Active Pixels	Vertical Active Pixels	Refresh (Hz)	HDMI and DVI Support	VGA Support	Comments	Video Standard
1280x720,60	1280	720	60	✓	✓		VESA DMT
1280x720p,60	1280	720	60	✓	✓	720p	CEA 861
1280x720p,100	1280	720	100	✓	✓	720p	CEA 861
1280x720p,120	1280	720	120	✓	✓	720p	CEA 861
1280x768,60	1280	768	60	✓	✓		VESA DMT
1280x768,75	1280	768	75	✓	✓		VESA DMT
1280x768,85	1280	768	85	✓	✓		VESA DMT
1280x800,60	1280	800	60	✓	✓		VESA CVT
1280x960,60	1280	960	60	✓	✓		VESA DMT
1280x960,85	1280	960	85	✓	✓		VESA DMT
1280x1024,60	1280	1024	60	✓	✓		VESA DMT
1280x1024,75	1280	1024	75	✓	✓		VESA DMT
1280x1024,85	1280	1024	85	✓	✓		VESA DMT
1360x768,60	1360	768	60	✓	✓		VESA DMT
1400x1050,60	1400	1050	60	✓	✓		VESA DMT
1400x1050,75	1400	1050	75	✓	✓		VESA DMT
1440x900,60	1440	900	60	✓	✓		VESA DMT
1440x900,75	1440	900	75	✓	✓		VESA DMT
1440x900,85	1440	900	85	✓	✓		VESA DMT
1600x1200,60	1600	1200	60	✓	✓		VESA DMT
1680x1050,60	1680	1050	60	✓	✓		VESA CVT
1920x1080i,50	1920	540	50	✓		HDMI & DVI only - 1080i	CEA 861
1920x1080i,60	1920	540	60	✓		HDMI & DVI only - 1080i	CEA 861
1920x1080p,25	1920	1080	25	✓	✓	1080p	CEA 861
1920x1080p,30	1920	1080	30	✓	✓	1080p	CEA 861
1920x1080p,50	1920	1080	50	✓	✓	1080p	CEA 861
1920x1080,60	1920	1080	60		✓	VGA only	VESA CVT
1920x1080p,60	1920	1080	60	✓	✓	1080p	CEA 861
1920x1200,60	1920	1200	60	✓	✓	Reduced Blanking	VESA CVT

Composite and S-Video Supported Input Resolutions

Composite and S-Video Supported Input Resolutions					
Resolution Name	Horizontal Active Pixels	Vertical Active Pixels	Refresh (Hz)	Comments	Video Standard
720x480i,60	720	240	60	480i	CEA
720x576i,50	720	288	50	576i	CEA

Component Video Supported Input Resolutions

Component Video Supported Input Resolutions					
Resolution Name	Horizontal Active Pixels	Vertical Active Pixels	Refresh (Hz)	Comments	Video Standard
720x480i,60	720	240	59.9	480i	CEA 770.2
720x480p,60	720	480	59.9	480p	SMPTE 293M CEA 770.2 ITU-R BT. 1358
720x576i,50	720	288	50	576i	
720x576p,50	720	576	50	576p	ITU-R BT. 1358
1280x720p,60	1280	720	59.9	720p	SMPTE 296M CEA 770.3
1920x1080i,50	1920	540	50	1080i50	SMPTE 274M
1920x1080i,60	1920	540	59.9	1080i	SMPTE 274M CEA 770.3
1920x1080p,50	1920	1080	50	1080p50	SMPTE 274M
1920x1080p,60	1920	1080	59.9	1080p	SMPTE 274M

Appendix F - Supported Output Resolutions

HDMI and DVI Supported Output Resolutions

The resolutions in the following table are supported on the DX-RX and can be set using a SEND_COMMAND. The horizontal/vertical/refresh information from the Resolution Name (in the first column) can be entered in a SEND_COMMAND command (VIDOUT_RES_REF) to specify scaling parameters for the DX-RX. For complete command information, see page 66.

IMPORTANT: *The resolutions and timings in the table below can only be changed with SEND_COMMANDs.*

HDMI and DVI Supported Output Resolutions					
Resolution Name	Horizontal Active Pixels	Vertical Active Pixels	Refresh (Hz)	Comments	Video Standard
640x480,60	640	480	60		VESA DMT
640x480,72	640	480	72		VESA DMT
640x480,75	640	480	75		VESA DMT
800x600,60	800	600	60		VESA DMT
800x600,72	800	600	72		VESA DMT
800x600,75	800	600	75		VESA DMT
1024x768,60	1024	768	60		VESA DMT
1024x768,70	1024	768	70		VESA DMT
1024x768,75	1024	768	75		VESA DMT
1280x720p,50	1280	720	50	720p	CEA 861
1280x720p,60	1280	720	60	720p	CEA 861
1280x768,60	1280	768	60		
1280x800,60	1280	800	60		VESA CVT
1280x1024,60	1280	1024	60		VESA DMT
1360x768,60	1360	768	60		VESA DMT
1440x900,60	1440	900	60		VESA CVT
1600x1200,60	1600	1200	60		VESA DMT
1680x1050,60	1680	1050	60		VESA CVT
1920x1080,60	1920	1080	60	1080	VESA CVT
1920x1080p,50	1920	1080	50	1080p	CEA 861
1920x1080p,60	1920	1080	60	1080p	CEA 861
1920x1200,60	1920	1200	60	Reduced Blanking	VESA CVT-R

Digital Video Output Resolution Support

IMPORTANT: *The resolutions and timings in the list below can only be set using DGX Configuration Software via the Enova DGX Switcher when the DXLink Receiver is being used directly from a DXLink output board.*

CEA (RGB Color Space):

640x480p,59Hz
 720x480p,59Hz
 720(1440)x480i,59Hz
 720x480p,60Hz
 720x480p,119Hz
 720x480p,120Hz
 720x480p,239Hz
 720x480p,240Hz
 720x576p,50Hz
 720(1440)x576i,50Hz
 720x576p,100Hz
 720x576p,200Hz
 768x576p,50Hz
 960x576p,50Hz
 960(1920)x576i,50Hz
 1280x720p,23Hz
 1280x720p,24Hz
 1280x720p,25Hz
 1280x720p,29Hz
 1280x720p,30Hz
 1280x720p,50Hz
 1280x720p,59Hz
 1280x720p,60Hz
 1280x720p,100Hz
 1280x720p,119Hz
 1280x720p,120Hz
 1920x1080p,23Hz
 1920x1080p,24Hz
 1920x1080i,25Hz
 1920x1080p,25Hz
 1920x1080i,29Hz
 1920x1080p,29Hz
 1920x1080i,30Hz
 1920x1080p,30Hz
 1920x1080p,50Hz
 1920x1080p,59Hz
 1920x1080p,60Hz

CVR (RGB Color Space):

IMPORTANT: *The resolutions and timings in the list below can only be set using DGX Configuration Software via the Enova DGX Switcher when the DXLink Receiver is being used directly from a DXLink output board.*

768x480p,60Hz
800x600p,60Hz
800x600p,120Hz
848x480p,60Hz
960x600p,60Hz
1024x576p,60Hz
1024x640p,60Hz
1024x768p,60Hz
1024x768p,120Hz
1064x600p,60Hz
1152x720p,60Hz
1152x864p,60Hz
1224x768p,60Hz
1280x720p,60Hz
1280x768p,60Hz
1280x768p,120Hz
1280x800p,120Hz
1280x960p,60Hz
1280x1024p,60Hz
1360x768p,60Hz
1360x768p,120Hz
1400x1050p,60Hz
1440x900p,60Hz
1536x960p,60Hz
1600x1000p,60Hz
1600x1200p,60Hz
1680x1050p,60Hz
1704x960p,60Hz
1728x1080p,60Hz
1800x1350p,60Hz
1864x1050p,60Hz
1920x1080p,60Hz
1920x1200p,60Hz

CVT (RGB Color Space):

IMPORTANT: *The resolutions and timings in the list below can only be set using DGX Configuration Software via the Enova DGX Switcher when the DXLink Receiver is being used directly from a DXLink output board.*

640x360p,85Hz	1280x720p,50Hz
640x400p,75Hz	1280x720p,60Hz
640x400p,85Hz	1280x720p,75Hz
640x480p,75Hz	1280x720p,85Hz
640x480p,85Hz	1280x768p,50Hz
768x480p,60Hz	1280x768p,60Hz
768x480p,75Hz	1280x768p,75Hz
768x480p,85Hz	1280x768p,85Hz
800x600p,50Hz	1280x800p,50Hz
800x600p,60Hz	1280x800p,75Hz
800x600p,75Hz	1280x800p,85Hz
800x600p,85Hz	1280x960p,50Hz
848x480p,50Hz	1280x960p,60Hz
848x480p,60Hz	1280x960p,75Hz
848x480p,75Hz	1280x960p,85Hz
848x480p,85Hz	1280x1024p,50Hz
960x600p,50Hz	1280x1024p,60Hz
960x600p,60Hz	1280x1024p,75Hz
960x600p,75Hz	1280x1024p,85Hz
960x600p,85Hz	1360x768p,50Hz
1024x576p,50Hz	1360x768p,60Hz
1024x576p,60Hz	1360x768p,75Hz
1024x576p,75Hz	1360x768p,85Hz
1024x576p,85Hz	1400x1050p,50Hz
1024x640p,50Hz	1400x1050p,60Hz
1024x640p,60Hz	1400x1050p,75Hz
1024x640p,75Hz	1440x900p,60Hz
1024x640p,85Hz	1440x900p,75Hz
1024x768p,50Hz	1440x900p,85Hz
1024x768p,60Hz	1536x960p,50Hz
1024x768p,75Hz	1536x960p,60Hz
1024x768p,85Hz	1536x960p,75Hz
1024x768p,85Hz	1600x1000p,50Hz
1024x768p,85Hz	1600x1000p,60Hz
1024x768p,85Hz	1600x1200p,50Hz
1024x768p,85Hz	1600x1200p,60Hz
1024x768p,85Hz	1680x1050p,50Hz
1024x768p,85Hz	1680x1050p,60Hz
1064x600p,50Hz	1704x960p,50Hz
1064x600p,60Hz	1704x960p,60Hz
1064x600p,75Hz	1728x1080p,50Hz
1064x600p,85Hz	1728x1080p,60Hz
1152x720p,50Hz	1864x1050p,50Hz
1152x720p,60Hz	1864x1050p,60Hz
1152x720p,75Hz	1920x1080p,50Hz
1152x720p,85Hz	1920x1200p,50Hz
1152x864p,60Hz	
1224x768p,50Hz	
1224x768p,60Hz	
1224x768p,75Hz	
1224x768p,85Hz	

DMR (RGB Color Space):

IMPORTANT: *The resolutions and timings in the list below can only be set using DGX Configuration Software via the Enova DGX Switcher when the DXLink Receiver is being used directly from a DXLink output board.*

1280x800p,60Hz
 1366x768p,60Hz
 1600x900p,60Hz

DMT (RGB Color Space):

IMPORTANT: *The resolutions and timings in the list below can only be set using DGX Configuration Software via the Enova DGX Switcher when the DXLink Receiver is being used directly from a DXLink output board.*

640x350p,85Hz
 640x400p,85Hz
 640x480p,60Hz
 640x480p,72Hz
 640x480p,75Hz
 640x480p,85Hz
 720x400p,85Hz
 800x600p,56Hz
 800x600p,60Hz
 800x600p,72Hz
 800x600p,75Hz
 800x600p,85Hz
 848x480p,60Hz
 1024x768i,43Hz
 1024x768p,60Hz
 1024x768p,70Hz
 1024x768p,75Hz
 1024x768p,85Hz
 1152x864p,70Hz
 1152x864p,75Hz
 1152x864p,85Hz
 1280x800p,60Hz
 1280x960p,60Hz
 1280x960p,75Hz
 1280x960p,85Hz
 1280x1024i,43Hz
 1280x1024p,60Hz
 1280x1024p,75Hz
 1280x1024p,85Hz
 1360x768p,60Hz
 1366x768p,60Hz
 1600x1200i,48Hz
 1600x1200p,60Hz

Appendix G - Ground Wire Attachment

Applicability

This appendix covers attaching a ground wire to a DXLink Module without a designated ground location. If the module has a designated ground screw, see page 37.

If the system is experiencing problems with delivery of DXLink signals to/from an Enova DGX Digital Media Switcher or Enova DVX Solution, adding a ground wire from the TX/RX to the switcher may improve performance. The problem is likely caused by the use of a single phase powered system that does not provide an earth ground for a source or destination's chassis and shields. This can inject unnecessary AC voltage on the HDMI cable shield that can lead to DXLink signal integrity issues. To check for indications of this type of power in the system, look for a two pronged plug or a cord that has only two wires.

NOTE: *Technically this type of grounding is only required when a DXLink Transmitter or Receiver is connected to an ungrounded device, but this added grounding measure can be used at the discretion of the installer.*

Items Required

- ❑ Small adjustable wrench or socket driver
- ❑ 6 foot ground wire with ring terminal ends (provided)

NOTE: *Currently shipping DXLink Transmitters and Receivers provide a designated ground location on the rear of the chassis for attaching a ground wire. For instructions on attaching a ground wire to DXLink Modules or DXLink Wallplates with a designated ground location, see page 37.*

Attaching a Ground Wire to a Common Earthed Ground

Connect the running end of the ground wire (fixed end attached to DXLink Module or Wallplate) to a common earthed ground (ideally, referenced to the Enova DGX Switcher).

IMPORTANT: *If one DXLink Transmitter or Receiver is grounded, any remaining ungrounded units that are connected to the same board on the Enova DGX Switcher must also be grounded.*

Attaching a Ground Wire to Module without Designated Ground

Earlier model DXLink Transmitter and Receiver Modules without a designated location support chassis ground attachment through the HDMI jackscrew on the rear of the chassis.

IMPORTANT: *Before attaching the ground wire to the chassis, ensure all connectors are clear.*

To attach a ground wire to a module with a jackscrew:

1. If powered, power down the DXLink Module.
2. Remove the jackscrew and silver washer above the HDMI connector.

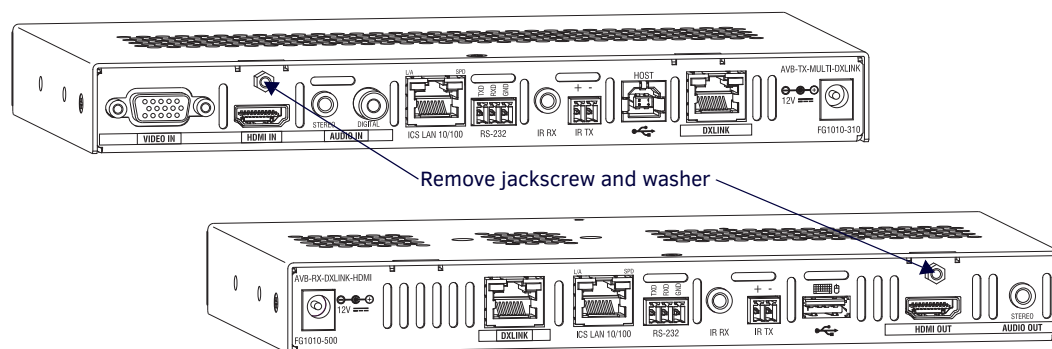

FIG. 44 Remove jackscrew and washer above HDMI connector

3. Secure the ring terminal of the ground wire against the chassis with the jackscrew and washer.

4. Ensure the ground wire is positioned so that it does not interfere with any of the connectors.

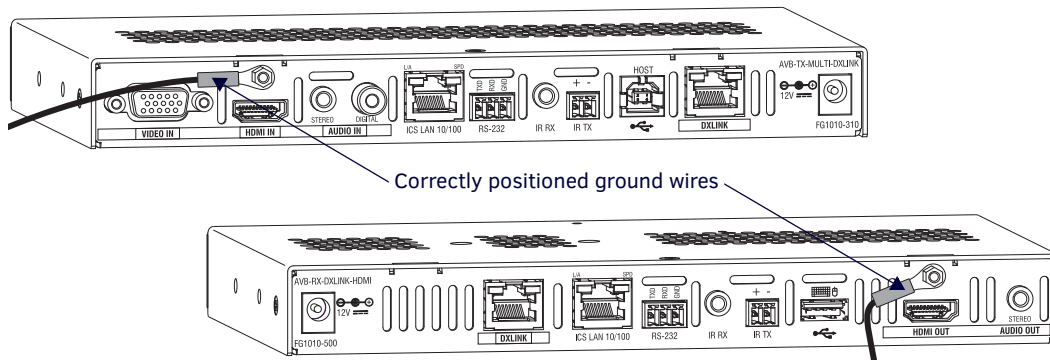

FIG. 45 Position ground wire away from connectors

5. Attach the ground wire to a common earthed ground (see “Attaching a Ground Wire to a Common Earthed Ground” on the previous page).
6. Continue the installation process (or reapply power to the module).

Appendix H - EDID Programming

DGX Configuration Software Overview

IMPORTANT: *If the TXs/RXs are configured for auto-setup via a connected Enova DGX Switcher with a 100 Series CPU, the information in this chapter will not apply. For information on using the System Configuration interface to handle EDID management/programming concerns, see the “Hardware Reference Manual - Enova DGX 100 Series Digital Media Switchers.”*

IMPORTANT: *Because signals routed through DXLink Transmitters normally produce a quality image, you will not need the information in this appendix unless the installation has special EDID requirements for VGA.*

AMX's DGX Configuration Software has a tabbed view for EDID Programming. This view can be used to re-program the EDID EEPROM chips for the HD-15 connectors on the DXLink Transmitters, allowing for custom configuration of the EDID data that is stored on them.

NOTE: *The remaining tabbed views in the software do not apply to the DXLink units. Scaling and HDCP settings can be applied via SEND_COMMANDs (see the chapter “NetLinx Programming of DXLink Transmitters and Receivers” on page 64). If a DXLink Receiver is connected to an Enova DGX Output Board, DGX Configuration Software can be used via the switcher for scaling (see the switcher's manual).*

DGX Configuration Software is available at www.amx.com (on the Multi-Format Transmitter's product page) and includes a standard Help file with detailed information.

PC System Requirements for DGX Configuration Software v1.0.5

- Windows 7 and Windows XP Professional
- Minimum Hardware: 166 MHz, 128 MB RAM, 36 MB of free disk space*, 800x600 display, serial port, video card with dual outputs (see Caution below)
- Recommended Hardware: 2.0 GHz, 512 MB RAM*

* The installation process requires 36 MB of disk space for the DGX Configuration Software installer. Once installed, the program requires 10 MB of disk space.

CAUTION: *We strongly urge the user not to use video cards with DMS-59 connectors. Video cards with DMS-59 connectors have been shown to fail consistently and, in the worst case, can corrupt an EDID data file. A laptop PC with a VGA or DVI out is a good solution. Cards with 2 DVI connectors, 2 VGA connectors, or 1 DVI and 1 VGA connector are also acceptable.*

Software Installation on PC

IMPORTANT: *Administrator rights are required to install DGX Configuration Software.*

To install DGX Configuration Software:

1. From the DXLink Multi-Format Transmitter's product page at www.amx.com (under Application Files on the right) double-click, “DGX Configuration Software.”
2. Click “I Accept” for the AMX License Agreement, and then select Open to download the file.
3. Optional – Select DGX_Config_SoftwareReadMe_vX_X to read about the software before installation.
4. Click the application file (which is zipped).
5. In the Compressed (zipped) Folders dialog box, click Extract All.
6. Select a destination for the files.
7. When the download is complete, click the application file and follow the directions in the installation wizard.

DXLink Connection to PC

To use DGX Configuration Software with a DXLink Transmitter:

1. Attach one end of a USB mini-B cable to the Program port on the front of the DX-TX (on the Wallplate TX, the Program port is on the left side; on the Decor Wallplate TX, the Program port is in the center on the front under the customer provided cover plate).
2. Attach the open end of the USB mini-B cable to the PC where the DGX Configuration Software was installed.
3. Apply power to the Transmitter. If power is via the DXLink connection, then apply power to the power sourcing device (i.e., switcher, PDXL-2, or PS-POE-AT-TC).
4. On the PC, open the DGX Configuration Software.

NOTE: *The PC will automatically establish a virtual COM port on the Transmitter.*

5. If changing the communication settings is necessary*:
 - a. From the Communication menu (in the DGX Configuration Software), select Serial Port.
 - b. Select Change Settings to change the serial port and/or the baud rate for the PC's serial port. The baud rate for the PC must match the baud rate for the Transmitter. The recommended (default) baud rate setting for USB serial communication with DXLink Transmitters through the Program port is 9600.
 - c. If you changed any of the settings, from the Communication menu select Refresh Device Lists.
6. Select the EDID tab in the interface (defaults to the Scaler Mode tab**).

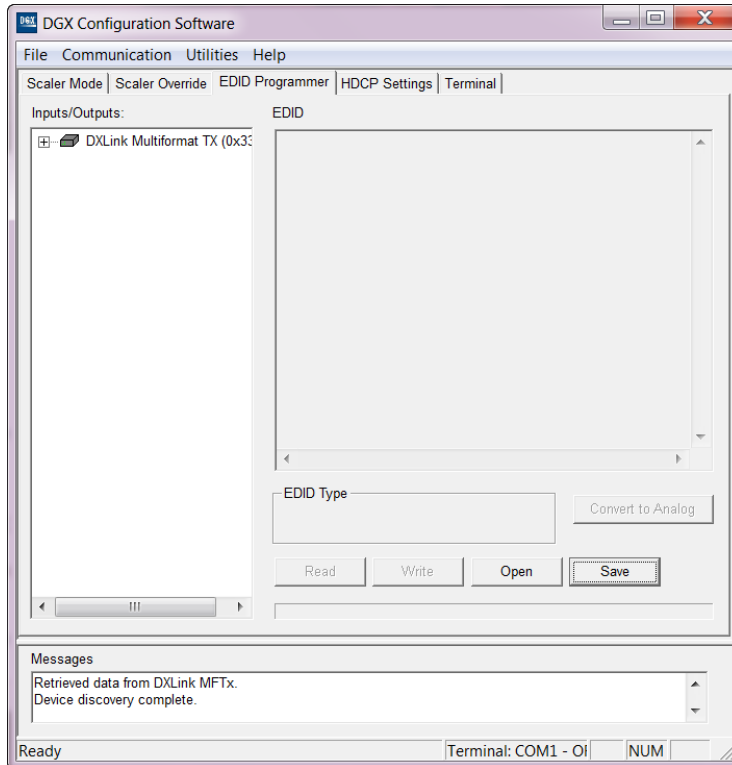

* If you are unsure of the USB Serial Port (COM <number>) being used, on the PC go to Start > Control Panel > Device Manager and expand the "Ports" to verify the COM number.

** The remaining tabs do not apply to the DXLink Transmitters. Scaling and HDCP settings can be applied via SEND_COMMANDS (see page 64).

General Notes for Working with DGX Configuration Software and DXLink TXs

When the DXLink Transmitter is connected to a PC running DGX Configuration Software, the following applies:

- DGX Configuration Software displays the connected Transmitter only.
- File menu – Select Open File to load an .edid file to the program. Select Save to File to save an .edid file containing the currently displayed settings in the EDID Programmer view.
- Communication menu – Use to change the serial communication settings. This menu also includes the option to "Refresh Device Lists," which will refresh the device list in the EDID Programmer tab.
- Utilities menu – This menu does not apply to the DXLink Transmitters.
- Help menu – Access the Help file for the program, open a link for the Web Update option (to download updates for the program), and view current version information.
- Messages in the bottom pane of the DGX Configuration Software dialog box report status of operations. Messages can be copied* for technical support purposes.

* Right-click on a message to access a short-cut menu with options to Copy Selected, Copy All, or Clear. When copying multiple messages: either select consecutive items by holding down the Shift key and clicking the first and last item or select nonconsecutive items by holding down the Control key and clicking on each item.

EDID Programmer View

From the EDID Programmer view, EDID EEPROM chips for the HD-15 (VGA) connector on the Transmitter can be re-programmed if necessary.

NOTE: *The EDID Programmer will not work in conjunction with the HDMI connector on the TX.*

EDID Overview

EDID (Extended Display Identification Data) is a data structure established by the Video Electronics Standards Association (VESA) to enable plug-and-play support by enabling easy configuration of a computer's graphics subsystem based on the capabilities of the attached display device.

EDID information includes items such as the following:

- Manufacturer's name
- Product type
- Supported video resolutions and refresh rates
- Color space and filter chromaticity
- Detailed timings

When a computer is directly connected to a display device, it can use the display device's EDID information to determine an initial compatible video signal to send. With the computer's display controls, the user can modify this selection to another compatible signal based on the provided EDID information.

DXLink Equipment and EDID

In cases where the HD-15 (VGA) input on a DXLink Transmitter are used and a resolution incompatibility exists (or if the source device needs a specific resolution or a limited set of resolutions), the DXLink Transmitters have the ability to update the VGA EDID emulation file (by updating the EEPROM chip) which comes preloaded with an AMX VGA EDID set.

The AMX VGA EDID set consists of a number of common EDID settings (for VGA timing details, see page 107). In most cases, the DXLink Transmitter can be used as is from the factory with no adjustments.

The DGX Configuration Software with EDID programming functionality has been provided for cases where a user defined VGA EDID set is desired (this must be a subset of the supported input resolutions shown in Appendix E; see page 107).

The EDID Programmer view can be used for writing user defined VGA EDID data to the DXLink Transmitter's HD-15 input.

Reading and Saving EDID Data from a DXLink TX's HD-15 (VGA) Input Connector

The DGX Configuration Software reads the EDID data from the USER EDID 1 EEPROM location, regardless of the VIDIN_EDID setting.

IMPORTANT: *Unless a custom EDID has been previously written to the input, attempting to read the EDID will result in a Read Error message.*

The EDID data can be read to confirm the correct EDID has been programmed.

To read and save EDID data from a DXLink Transmitter:

1. On the PC, open the DGX Configuration Software and select the EDID Programmer tab.
2. Under Inputs/Outputs on the left, expand the device tree, and select the HD-15 input.
3. Click Read to read the VGA EDID information currently on the HD-15 input.
4. The EDID data appears in the EDID read-only field on the right.

TIP: *In the EDID Programmer view, the Save to File option under the File menu can be used to save the EDID information as an .edid file. The saved file can be opened as a text file (from the File menu, select Open File) and edited or opened and written to an input (click the Write button).*

Read Error Message

A Read Error message will appear if the Transmitter has never been programmed with a valid/custom EDID or if the unit has been programmed with a corrupted EDID. A Read Error message will also appear when attempting to read the EDID after sending a FACTORYAV SEND_COMMAND, which re-initializes the VGA USER EDID 1 EEPROM and resets the VIDIN_EDID setting to ALL RESOLUTIONS (which is AMX_0500_003).

Writing EDID Data to a DXLink Transmitter's HD-15 (VGA) Input Connector

The instructions that follow tell how to use the EDID Programmer view to write user defined VGA EDID information to the HD-15 input connector on a DXLink Transmitter. User defined VGA EDIDs are currently available from technical support.

AMX EDID Library

A library of VGA EDID files are available at www.amx.com (search for EDID Library). This library provides EDID files that can be used with AMX products. A report is provided for each EDID file, which describes the EDID features in detail, in order to assist you in selecting the most appropriate EDID for your system needs.

- Check the Library to determine if one of the custom EDID files meets your needs. (The custom EDID files are variants of base/standard EDIDs.)
- DGX Configuration Software can be used to reprogram the EDID on the input port with one of the .edid files provided in the EDID Library.

To write VGA EDID data to a DXLink Transmitter:

1. Download the VGA EDID set provided by technical support.
2. On the PC, open the DGX Configuration Software and select the EDID Programmer tab.

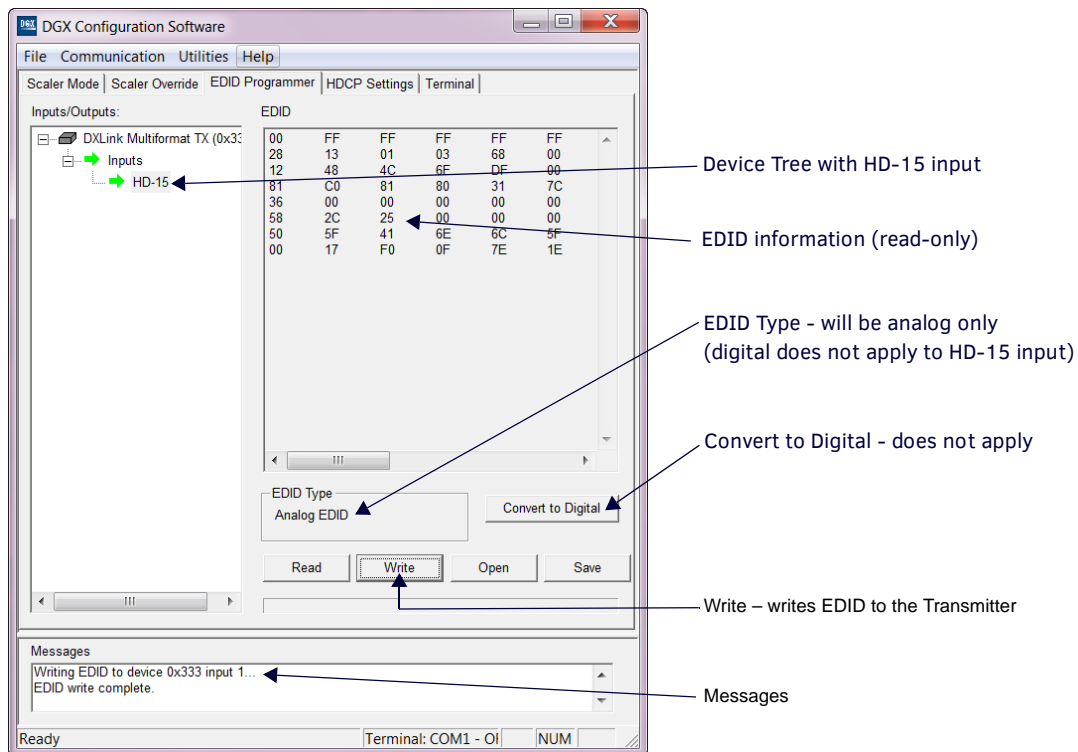

3. Under Inputs/Outputs on the left, expand the device tree, and select the HD-15 input.
4. From the File menu, select Open File to select the VGA .edid file that was downloaded in Step 1.
5. Click Write to write the VGA EDID information to the HD-15 input.

TIP: You can confirm that the new VGA EDID data was written to the HD-15 input by selecting the HD-15 input and clicking on the Read button or by using the `SEND_COMMAND ?VIDIN_EDID`, which will return: `VIDIN_EDID-USER EDID 1`.

IMPORTANT: You can revert to the factory default EDID for the HD-15 input by using the `SEND_COMMAND VIDIN_EDID-ALL RESOLUTIONS` (i.e., `AMX_0500_003`).



© 2015 Harman. All rights reserved. SmartScale, NetLinx, Enova, AMX, AV FOR AN IT WORLD, and HARMAN, and their respective logos are registered trademarks of HARMAN. Any other company or brand name referenced may be trademarks/registered trademarks of their respective companies.

AMX does not assume responsibility for errors or omissions. AMX also reserves the right to alter specifications without prior notice at any time.

The AMX Warranty and Return Policy and related documents can be viewed/downloaded at www.amx.com.

3000 RESEARCH DRIVE, RICHARDSON, TX 75082

AMX.com | 800.222.0193 | 469.624.8000 | +1.469.624.7400 | fax 469.624.7153

Last Revised:
12/15/2015