

DENON®

DP-450USB

TURNTABLE

Quick Start Guide

Kurzanleitung / Guide de démarrage rapide / Guida di Avvio Rapido /
Guía de inicio rápido / Snelhandleiding / Snabbstartsguide /
Краткое руководство пользователя / Skrócona instrukcja obsługi /
かんたんスタートガイド / 快速入门指南

Read Me First....

Bitte zuerst lesen... / Lisez-moi en premier... / Nota preliminare... /
Lea esto primero... / Lees mij eerst... / Läs detta först... /
Прочитайте в первую очередь... / Przeczytaj najpierw... /
はじめにお読みください... / 请先读我....

ENGLISH

DEUTSCH

FRANÇAIS

ITALIANO

ESPAÑOL

NEDERLANDS

SVENSKA

РУССКИЙ

POLSKI

日本語

中文简体字

Welcome

Thank you for choosing this unit. This guide provides step-by-step instructions for setting up this unit.

Please do not return this unit to the store – call for assistance.

If you need help... :











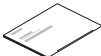

If you need additional help in solving problems, contact Denon customer service in your area.

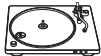
For details, see the Denon homepage.

www.denon.com

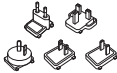
Before You Begin

What's In the Box

Quick Start Guide		Turntable	
Safety Instructions		Turntable sheet	
The main unit		45 rpm adaptor	
AC adapter		Head shell with cartridge	
AC adapter plugs (5 pieces)		Counterweight	
Dust cover		Audio cable	
Dust cover stand			

Required for Basic connections

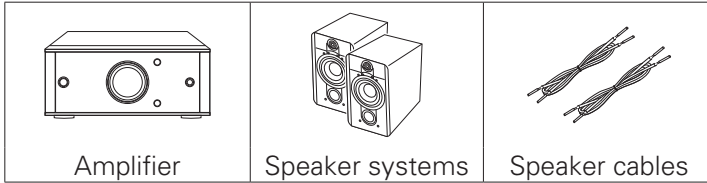

- These drawings are for illustrative purposes only and may not represent the actual product(s).

Setup

There are five steps to the setup process.

- 1** Assembly
- 2** Adjustments
- 3** Connections
- 4** Playback
- 5** Recording to a USB memory device

1 Assembly

Before use, attach the included parts to the main unit. Since a record player is susceptible to vibrations and tilting, place the main unit in a stable and flat location in advance.

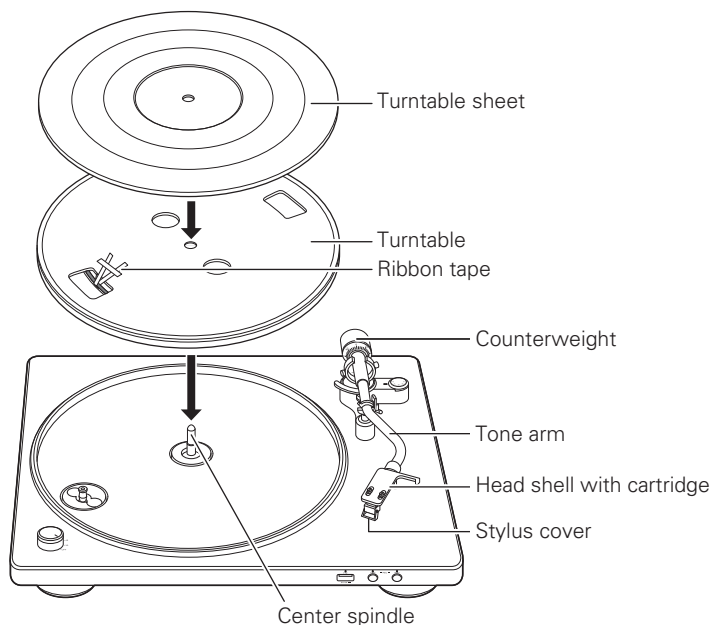

Mounting the turntable

1 Mount the hole in the center of the turntable on the center spindle.

2 Turn the turntable until the roller of the main unit is visible from the square hole on the side with the ribbon tape.

3 Pull out the ribbon tape, and hang the belt on the roller.

- Remove the ribbon tape after hanging the belt.

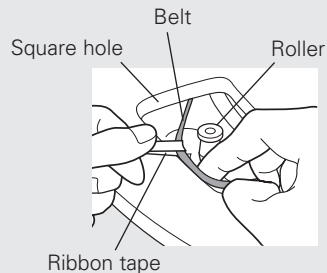

- Take care not to twist the belt when hanging it.
- Store the ribbon tape after use, as it is required when replacing the belt.

4 Mount the turntable sheet on the turntable.



- Mount the sheet with the side featuring the DENON logo facing down.

Mounting the counterweight

- 1 Insert the counterweight into the shaft on the back of the tone arm, and turn it in the direction of the arrow while gently pushing it.

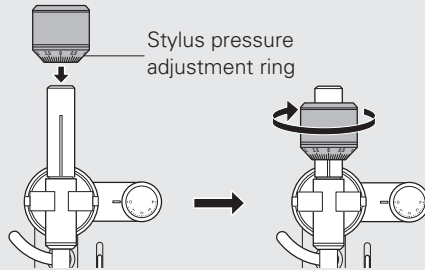

- Mount the counterweight so that its stylus pressure adjustment ring is facing the front.

Mounting the head shell with cartridge

- 1 Insert the head shell into the tip of the tone arm.
 - Insert the head shell with its guide pin facing up and aligned with the hole on the top of the tone arm.

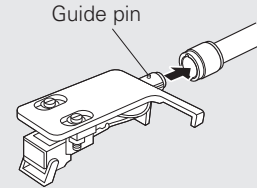

- 2 Turn the lock nut in the direction of the arrow to secure the head shell.

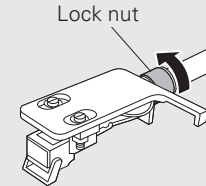

NOTE

- Perform this operation with the stylus cover of the cartridge lowered to protect the stylus tip.

2 Adjustments

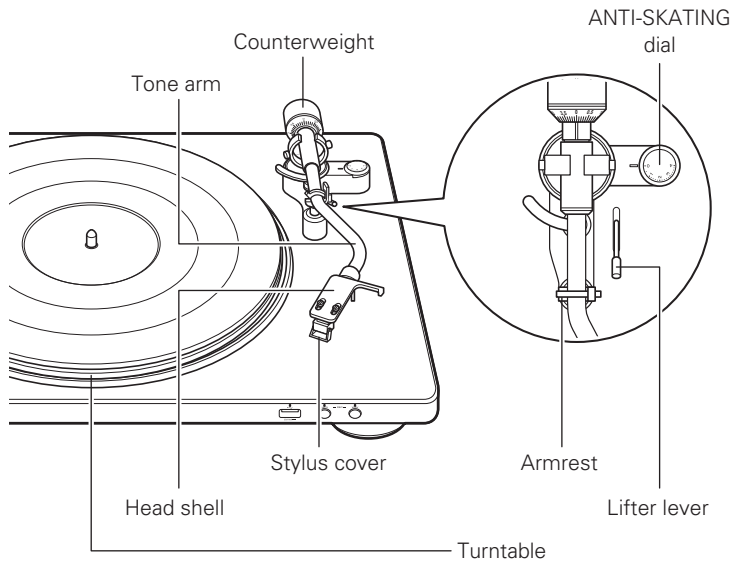

□ Adjusting the stylus pressure

- 1 Set the anti-skating dial to “0”.
- 2 Lower the lifter lever.
- 3 Release the lock on the armrest, grip the finger lift on the head shell, and move the tone arm over the turntable.

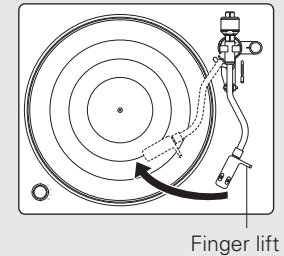
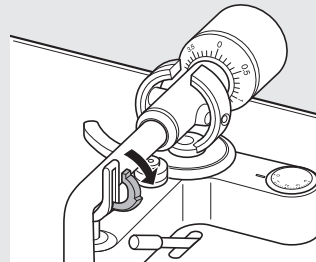

NOTE

- Perform this operation with the stylus cover of the cartridge lowered to protect the stylus tip.

4

Turn twist the counterweight so that the tone arm is floating parallel to the turntable.

- Perform adjustment by turning the counterweight gradually while periodically removing your hand to check the position.

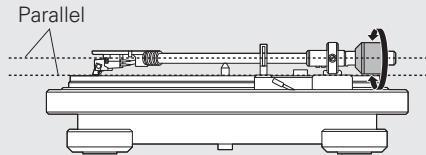
**5**

Return the tone arm to the armrest.

6

Holding the counterweight with a finger so that it does not move, turn the stylus pressure adjustment ring so that its “0” mark is lined up with the line on the tone arm.

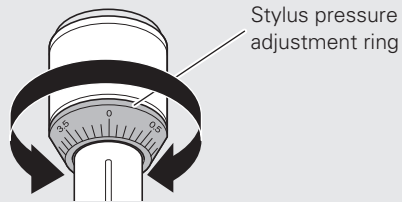
**7**

Turn the counterweight in the direction of the arrow so that the “2” mark of the stylus pressure adjustment ring is lined up with the single line on the tone arm.

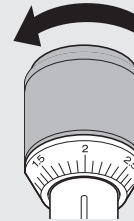

- The appropriate stylus pressure for the cartridge included with the main unit is 2.0 g (19.6 mN).

□ Adjusting anti-skating

1

Turn the anti-skating dial so that it is lined up with “2”.

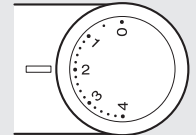

3 Connections

Connect an AC adapter conversion plug suitable for the power outlet you are using to the AC adapter.

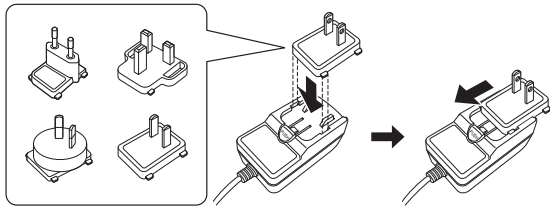

- It is recommended that the earth wire of the included audio cable is kept out of the way by securing it with a tie such as the twist tie of the audio cable.
- If a device connected to this unit has an earth terminal, connect the earth wire of the audio cable (supplied) to the earth terminal of this unit (SIGNAL GND). This may reduce noise during playback.
- When connecting to an amplifier with a PHONO input terminal, set the phono equalizer ON/OFF switch to "OFF".

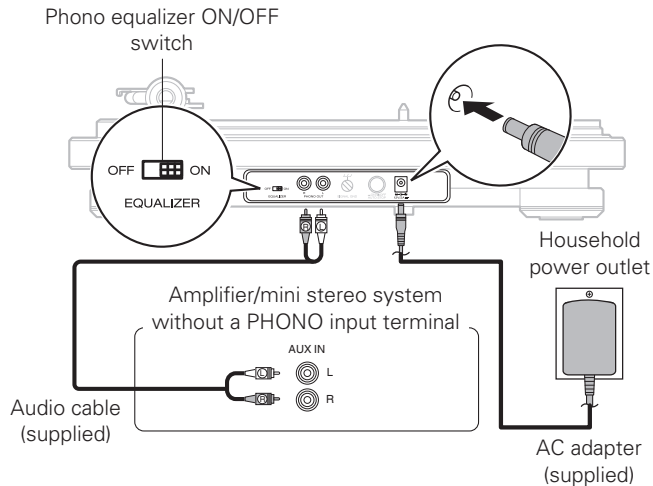

4 Playback

1 Place a record on the turntable.



- For EP (“doughnut”) records, insert the included 45 rpm adapter onto the center spindle.

2 Turn the power/rpm switch knob to match the turntable rpm with the rpm of the record. The turntable will start turning.

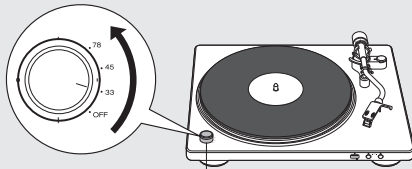

Power/rpm switch knob



- You can select 33 1/3, 45, 78 rpm as the turntable speed per minute.

3 Raise the stylus cover of the cartridge.

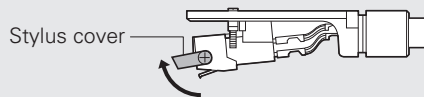

Stylus cover

4 Release the arm rest lock and raise the lifter lever.

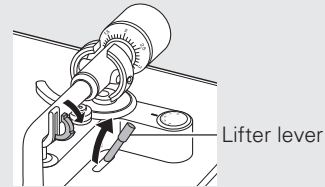

5 Grip the finger lift, and move the stylus tip directly above the start position of the track to play.

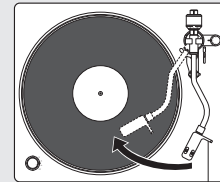

Finger lift

6 Lower the lifter lever.

The tone arm slowly lowers, and playback starts when the stylus tip reaches the record.

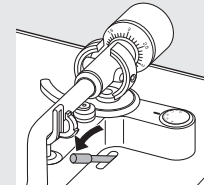

5 Recording to a USB memory device

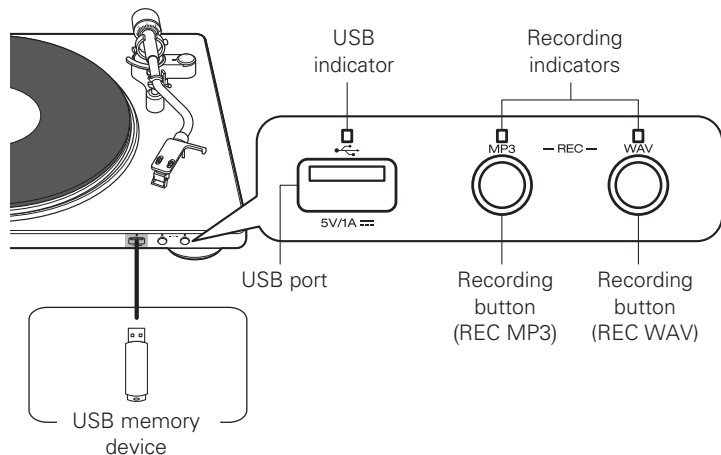

1 Insert the USB memory device into the USB port.

The USB indicator lights up in white.



- Prepare playback of the record for recording in advance.

2 Lower the stylus to a silent part of the record for recording.

3 Before recording begins, press the recording button for the file format when recording (REC MP3 or WAV).

The USB indicator flashes in white and recording starts.



- The recording indicator for the button you pressed will light up in blue.

4 When recording is complete, press the button that you pressed in step 3 to stop recording.

The recording indicator goes out and recording stops.



- The tracks that you have recorded to a USB memory device can be edited on a computer with the "MusiCut for DENON" digital music file editing software. For details, see the WEB manual.

Recordings you have made should only be used for your personal enjoyment, and as per copyright laws may not be used in other ways without permission of the copyright holder.

Using the dust cover

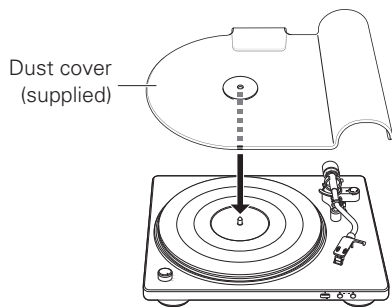

- Remove the dust cover before record playback.

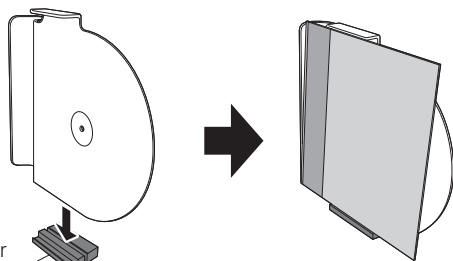

- Attach the dust cover to the included dust cover stand to use it as a record stand.

Owner's Manual

- For more information, visit [www.denson.com](http://www.denon.com)
- Refer to the Online Manual for other functions information and operation procedure details. manuals.denson.com/DP450USB/ALL/EN/



Online Manual

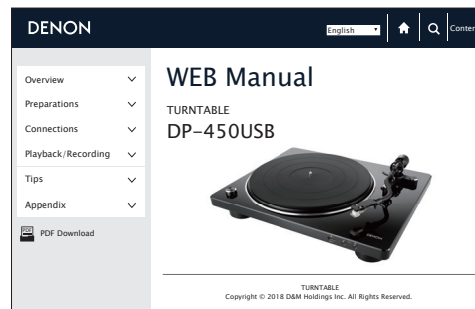

DENON®

www.denon.com

Printed in China 5411 11695 00AD
Copyright © 2018 D&M Holdings Inc. All Rights Reserved.