



engineered by  
**Snap**  
av

**OWNER'S MANUAL**

**Triple 8 and 10 in.  
Powered Subwoofers**

**ES-SUB-TRP8-300-BLK**

**ES-SUB-TRP10-500-BLK**



## IMPORTANT SAFETY INSTRUCTIONS

**WARNING:** To reduce the risk of fire or electric shock, do not expose this apparatus in or near rain or moisture.

1. Read and keep these instructions for future reference.
2. Do not use this apparatus near water.
3. Clean only with a dry cloth.
4. Do not block any ventilation openings. Install according to manufacturer's instructions.
5. Do not install near any heat sources such as radiators, heat registers, stoves or other apparatus (including amplifiers) that produce heat.
6. Do not override the safety purpose of the polarized or grounding-type plug. A polarized plug has two blades - one wider than the other. A grounding type plug has two blades and a third grounding prong. The wide blade or the third prong is provided for your safety. If the provided plug does not fit into your outlet, consult an electrician for replacement of the obsolete outlet.
7. Protect the power cord from being walked on or pinched particularly at plug, convenience receptacles, and the point where it exits from the apparatus.
8. Only use attachments/accessories specified by the manufacturer.
9. Use only with a cart, stand, tripod, bracket or table specified by the manufacturer, or sold with the apparatus. When a cart is used, use caution when moving the cart/apparatus combination to avoid injury from tip-over. 
10. Unplug this apparatus during lightning storms or when unused for long periods of time.
11. Refer all servicing to qualified service personnel. Servicing is required when the apparatus has been damaged in any way, such as when the power-supply cord or plug is damaged, liquid has been spilled or objects have fallen into the apparatus, the apparatus has been exposed to rain or moisture, does not operate normally, or has been dropped.
12. To completely disconnect this equipment from the AC mains, disconnect the power supply cord plug from the AC receptacle
13. This is CLASS II apparatus with double insulation, and no protective earth provided.
14. Do not expose this equipment to dripping or splashing and ensure that no objects filled with liquids, such as vases, are placed on the equipment.
15. To completely disconnect this equipment from the ac mains, disconnect the power supply cord plug from the ac receptacle.
16. The main plug of the power supply cord shall remain readily operable.



The lightning flash with arrowhead symbol, within an equilateral triangle, is intended to alert the user to the presence of uninsulated dangerous voltage within the product's enclosure that may be of sufficient magnitude to constitute a risk of electric shock to persons.



The exclamation point within an equilateral triangle is intended to alert the user to the presence of important operating and maintenance (servicing) instructions in the literature accompanying the appliance.

## WELCOME TO EPISODE®

Episode® is one of the most highly-regarded brands of speakers available today. We appreciate your business and we stand committed to providing our customers with the highest degree of quality and service in the industry. Episode® subwoofers are a superb choice for bass reinforcement of almost every type of audio system. They have been designed with advanced technology components that accurately reproduce low frequencies in all types of music and movies. For optimum system performance, we recommend pairing them with our acclaimed Episode® loudspeakers.

## FEATURES

### >>WORLD-CLASS BASH® HYBRID AMPLIFIER TECHNOLOGY

Incorporates the latest BASH® amplifier technology to maximize performance while generating little heat. In standby mode, the subwoofer consumes less than 0.5 watts making it one of the “greenest” solutions available.

### >>HIGH-GLOSS CABINET

Attractive furniture-quality cabinet provides the ultimate in rigidity and sound clarity.

### >>TUNED SYSTEM PERFORMANCE

Offers rear-mounted, low-pass crossover adjustment and a switchable phase control (0 or 180 degrees) to ensure optimal system integration, giving a seamless blend for an unbelievable music and movie experience.

### >>SIGNAL-SENSING FOR AUTOMATIC POWER CONTROL

There are three power mode options with an Episode® powered subwoofer: Always On, Audio Sense, and Trigger. When Trigger or Audio Sense is selected, the subwoofer will automatically switch to a power-saving standby mode until an input signal is detected. Power will turn on whenever a minimal amount of signal is detected on the input jacks, and off again when no signal is present for approximately 15 minutes.

### >>GOLD-PLATED INPUTS

Features stereo RCA line-level inputs for many two-channel applications. For home theater use, the right RCA unbalanced input also serves as an LFE (Low Frequency Effects) input for a direct connection from the receiver or processor. An XLR balanced input is provided for clean accurate audio from receivers or processors with balanced LFE outputs. For added versatility, there are also gold-plated, five-way binding-post inputs and outputs for speaker-level connections.

## INSTALLATION

### PLACING YOUR EPISODE® SUBWOOFER

Subwoofer placement can have an effect on the performance that you receive. All rooms are different, but the strongest output will likely occur if the subwoofer is placed in a corner of the room on the same wall as the front channel speakers. This is known as the boundary effect and will emphasize certain bass frequencies while canceling others.

Some listeners will find this to be the best sounding result, while others may find it overly “boomy” or muddy. Experiment with the placement options available to you and follow the fine tuning instructions that follow in the “Installation” section of this manual.

Note that due to the Triple Woofer design, it is recommended that the subwoofer is placed at a 45° angle at least 12” from the corner.

For ultimate flexibility in placement, use the Episode® Wireless Subwoofer Kit.

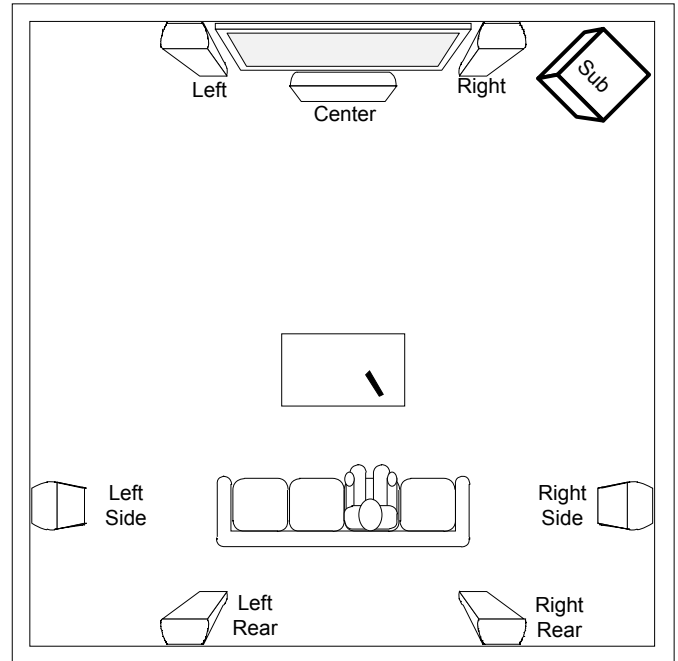

## SUBWOOFER CONTROLS

Your Episode® Subwoofer is suited to match nearly every home theater or music application:

### ES-SUB-TRP8-300

1. **VOLUME:** Controls the overall output level of the subwoofer.
2. **CROSSOVER:** Sets the low-pass crossover frequency from 40 Hz to 200Hz (LFE).
3. **PHASE:** Selects the subwoofer's phase response from 0 to 180°. (See FINE TUNING on pg. 9)
4. **TRIGGER MODE:** Sets the subwoofer's power mode:

Always On – Always Powered On

Trigger – Turns on when +12V is received at Trigger input

Audio Sense - Turns on when a minimal amount of audio signal is received at the audio inputs. Automatically turns off when no signal is present for approximately 15 minutes.

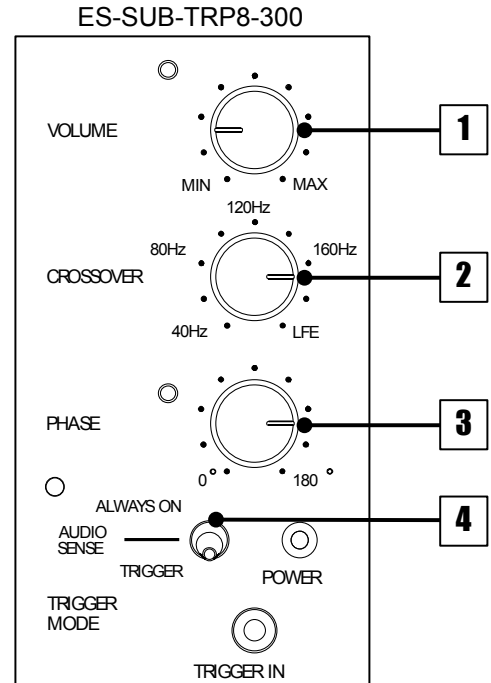

### ES-SUB-TRP10-500

1. **VOLUME:** Controls the overall output level of the subwoofer.
2. **CROSSOVER:** Sets the low-pass crossover frequency from 40 Hz to 120Hz.
3. **CROSSOVER MODE:** Sets the crossover mode from variable to LFE for home theater applications using an A/V receiver with a subwoofer output. When LFE is selected, the crossover is set to 120Hz.
4. **PHASE:** Selects the subwoofer's phase response from 0 to 180°. (See FINE TUNING on pg. 9)
5. **TRIGGER MODE:** Sets the subwoofer's power mode:

Always On – Always Powered On

Trigger – Turns on when +12V is received at Trigger input

Audio Sense - Turns on when a minimal amount of audio signal is received at the audio inputs. Automatically turns off when no signal is present for approximately 15 minutes.

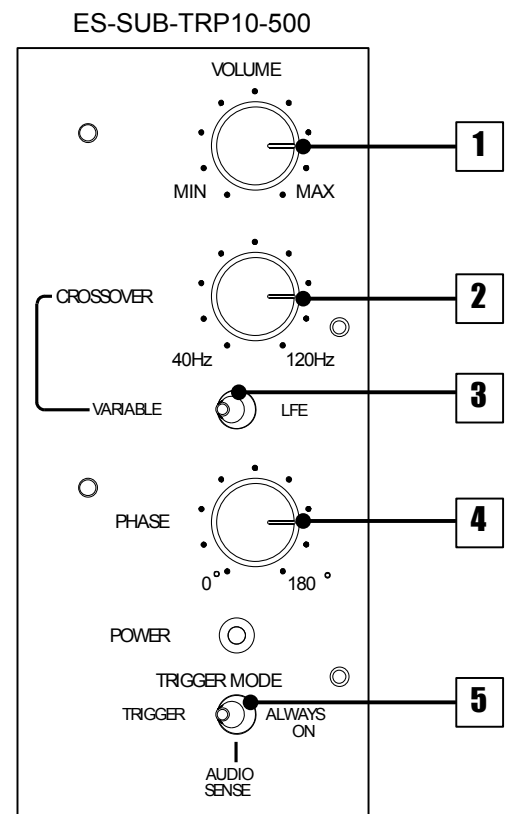

## GETTING CONNECTED

Episode® Powered Subwoofers are among the most flexible on the market today and can be configured for use in many different applications, as shown in the figures below.

- For line level connections, use high-quality RCA cables that feature low impedance, shielding and high-quality connectors.
- Use two-conductor loudspeaker wire for high level connections to the subwoofer and to any satellite loudspeakers that may be connected as well.
  - DO NOT connect wiring to both sets of inputs simultaneously. Example – If using loudspeaker level inputs, DO NOT connect an RCA cable to the subwoofer at the same time.

## LOW-LEVEL INPUTS

### ES-SUB-TRP8-300

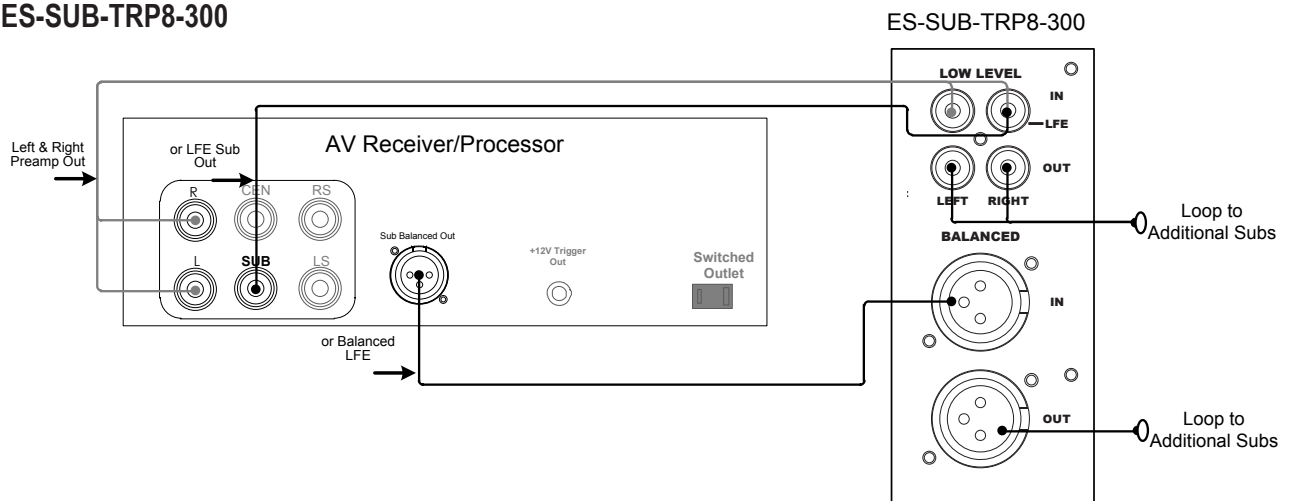

### ES-SUB-TRP10-500

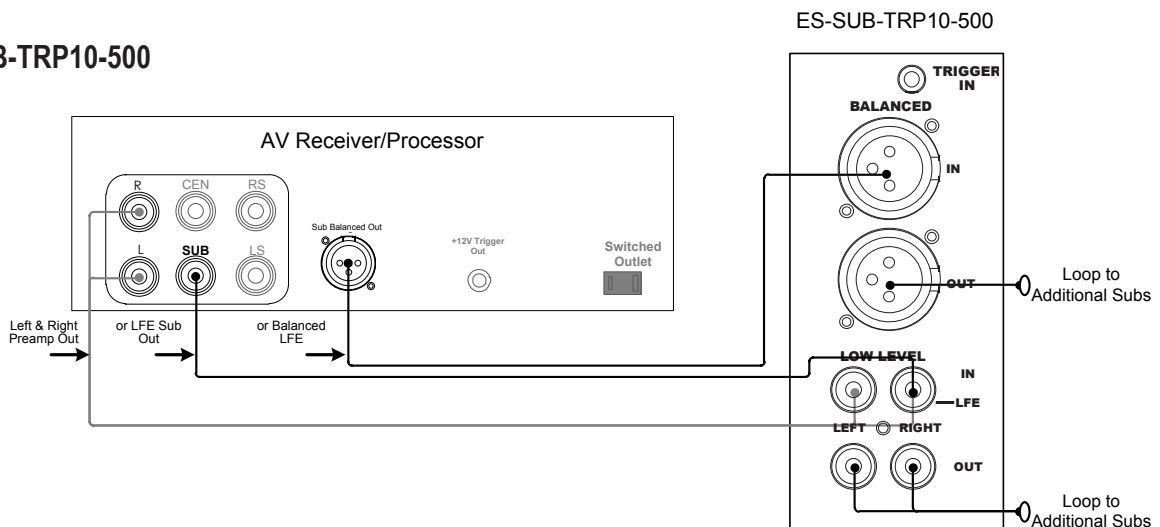

# HIGH-LEVEL INPUTS

## ES-SUB-TRP8-300

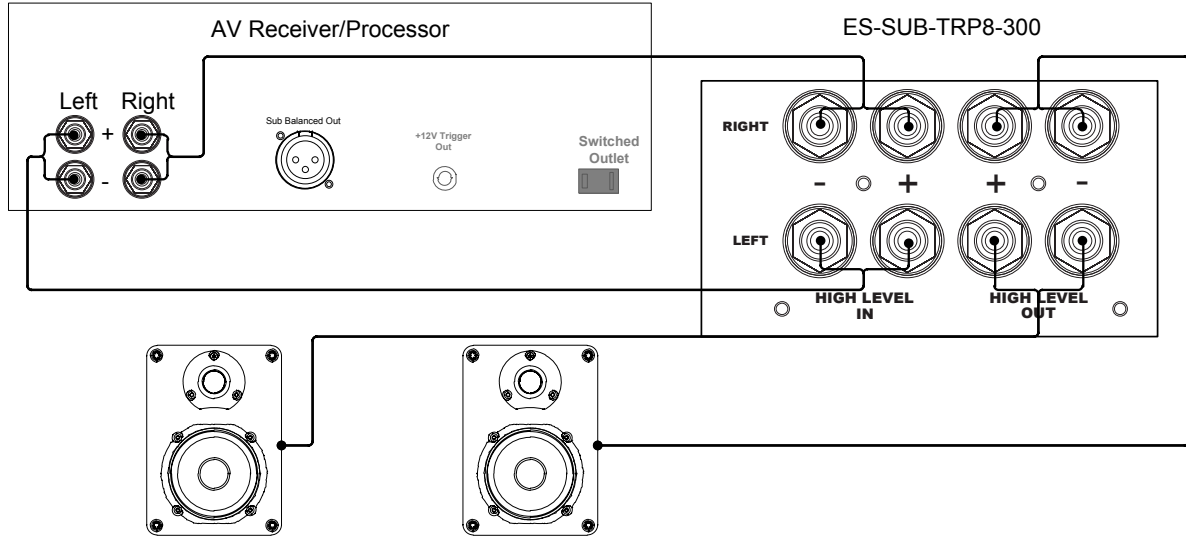

## ES-SUB-TRP10-500

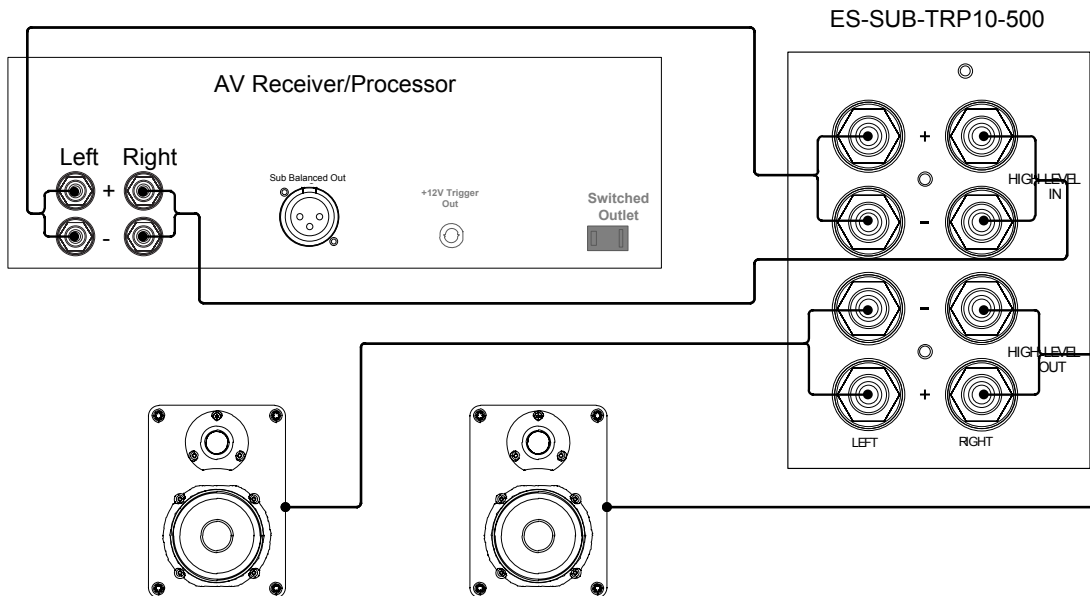

## 12V DC TRIGGER

The TRP8 and TRP10 are equipped with a 12V trigger input to turn the amplifier off, reducing power consumption when not in use. When this input receives a 12V signal, the amplifier will turn ON; when the signal goes away, the amplifier will turn OFF.

- Connect the 12V trigger output of the AV receiver to the 12V trigger input of the Trp8 or Trp10 using a high quality 3.5mm (1/8") mono cable.
- If the receiver does not have a 12V trigger output, using a 12V power supply plugged into a switched outlet on the receiver provides the same functionality.

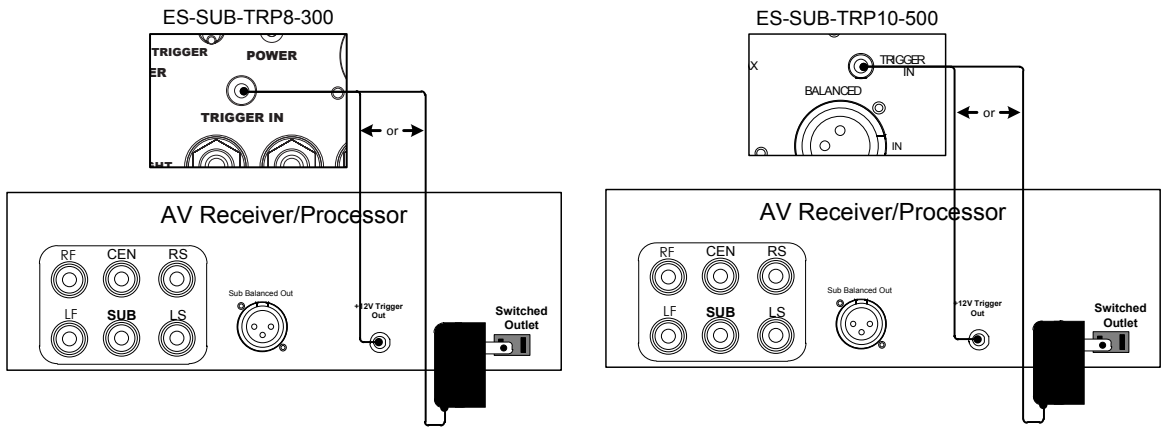

## 12V DC Trigger PIN Configuration

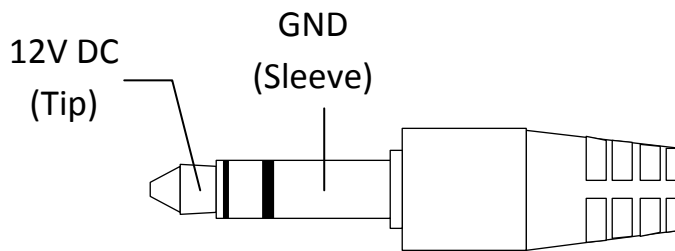



## FINE TUNING

After making all the connections and calibrating the sub, set up your Episode® subwoofer using the following steps:

*Note: When using an AV receiver and the LFE input, set the subwoofer calibration level to the factory setting before performing the following procedure. After making the below adjustments, calibrate the system via the AV receiver's setup procedure.*

1. Ensure that the subwoofer is plugged in.
2. Set the following controls and switches to positions that will enable tuning for maximum performance.
  - a. VOLUME knob set to 50%, or 12 o'clock
  - b. CROSSOVER knob set to 120 Hz or 5 o'clock
  - c. PHASE switch set to 0°

During initial setup, it may be helpful to set the TRIGGER MODE switch to the 'ON' position. Once calibration is complete, switch it to 'AUTO SENSE' to enable the automatic power-saving mode.

3. Play a movie scene or music track and set the system volume to an average level. Listen to the bass level from your favorite listening position. Adjust the VOLUME control as desired.
4. If deeper bass is desired, adjust the CROSSOVER control toward the lower frequencies. Experiment with different frequency settings until you find one that sounds best.

NOTE: When using the LFE input on the Trp10, set to LFE and make any crossover adjustments in the preamplifier or receiver crossover settings.

5. Continue listening to your favorite music and movie sources using the settings chosen for volume and crossover. Now, try experimenting with the PHASE switch until you find the best setting for the installation. Depending on your subwoofer's placement, the bass may sound louder or deeper when the phase has been optimized. In some cases, adjusting phase will make no discernible difference.

## INSTALLING AND REMOVING THE GRILLS

To remove the grills, gently pull the tabs on the outer edge of the grill frame to separate the grill from the baffle of the subwoofer. To install the grill, start in one top corner and gently press the grill frame in around the front baffle, pushing it in at each of the remaining three recessed holes.

## CLEANING

Use a soft cloth or paper towel to clean the cabinet. The grill is best cleaned by brushing it off with a lint-free cloth.

## SPECIFICATIONS

	ES-SUB-TRP8-300	ES-SUB-TRP10-500
Driver	(1) 8" Woven Fiberglass (2) 8" Passive Radiators	(1) 10" Woven Fiberglass (2) 10" Passive Radiators
Amplifier	300 watts RMS @ 0.2% THD	500 watts RMS @ 0.2% THD
Signal to Noise Ratio	90 dB A-weighted	90 dB A-weighted
Input Power	100-120V/220-240V, ~50/60Hz, 3.15A	100-120V/220-240V, ~50/60Hz, 5A
Frequency Response	30 Hz to 200 Hz	30 Hz to 180 Hz
Dimensions	(H) 11.81 in. (300 mm) x (W) 12.8 in. (325 mm) x (D) 12.8 in. (325 mm)	(H) 13.7 in. (347 mm) x (W) 14.9 in. (379 mm) x (D) 14.75 in. (374.5 mm)
Weight	31.9 lbs	44 lbs

## TROUBLESHOOTING

Episode® speakers are designed to function trouble-free. Most problems that occur are due to simple issues. If you have trouble, please check the list of simple fixes below. If the problem persists, contact Episode® Customer Service at 1.866.838.5052

### NO SOUND

- Verify that there is audio coming from the source selected. Select another source if necessary.
- Ensure that any A/V receivers are turned on and connected properly.
- Check cable connections at each subwoofer not producing sound for good contact.
- Ensure the subwoofer volume is turned up to a reasonable level. The control is located on the rear panel.
- During troubleshooting, it may be useful to temporarily set the MODE switch to 'ON' to ensure signal-sensing power mode is disabled.

## WARRANTY

### 10/2-Year Limited Warranty

Episode® Subwoofers have a 2-Year Warranty on the amplifier and a 10-Year Warranty on the woofer and box. This warranty includes parts and labor repairs on all components found to be defective in material or workmanship under normal conditions of use. This warranty shall not apply to products which have been abused, modified or disassembled. Products to be repaired under this warranty must be returned to SnapAV or a designated service center with prior notification and an assigned return authorization number (RA).

## CONTACTING TECHNICAL SUPPORT

Phone: (866) 838-5052

Email: [Techsupport@snapav.com](mailto:Techsupport@snapav.com)



engineered by  
**Snap**<sub>av</sub>