

### Using Maestro sensor switch with a companion switch

Lutron occupancy & vacancy motion sensors are passive infrared (PIR) sensors that automatically control lights. These sensors detect the heat from occupants moving within an area to determine when the space is occupied. The sensors then control the lights automatically turning them off or on, providing convenience and increased energy savings.

- 1**  **WARNING: Shock Hazard.** May result in serious injury or death. Turn off power at circuit breaker before installing the unit.

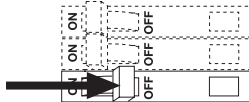

- 2** Remove wallplate and switch mounting screws. Carefully remove switch from wall leaving all wires attached. Identify switch type (Single pole, 3-way or 4-way) and tag the **COMMON** terminal.

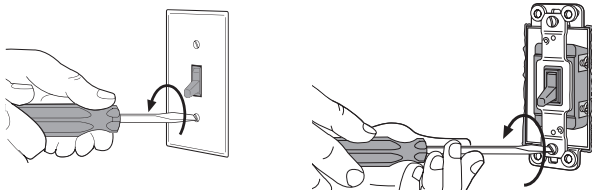

- 3** **Single pole (One location)** – Switch will have insulated wires connected to two screws of the same color plus a green ground screw. *See Diagram A*
- 3A** **3-way (Two locations)**– 3-way switches will have insulated wires connected to three screws plus a green ground screw. One of these wires is connected to a screw of a different color (not green) or labeled **COMMON**.

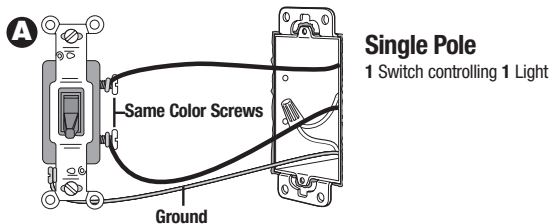

- 3B** Tag this wire on both switches to identify when removing. *See Diagram B*

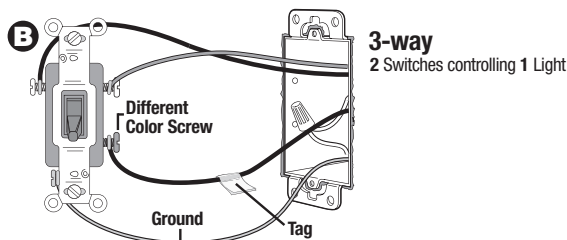

**3c 4-way (Three or more locations)** – 4-way switches will have insulated wires connected to four screws plus a green ground screw. Tag either set of two same-color insulated wires that are connected to different-colored screws (on the same side of the switch). Follow this procedure for each 4-way switch. **See Diagram C**

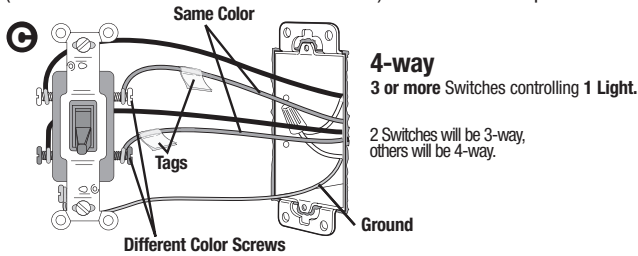

**4** Disconnect wires from the switches removed in step 2. The switches may have two wires attached to the same screw. Tape these two wires together before disconnecting.

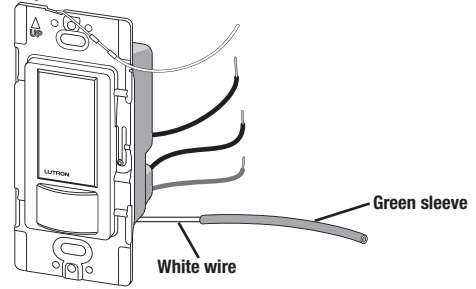
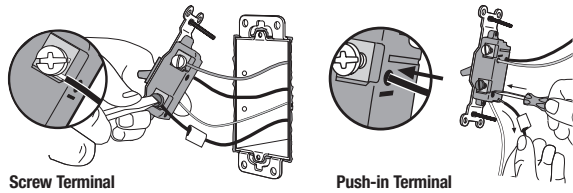

**5 Connect Maestro sensor switch and companion switches**

**5A Single pole (One location)** - Existing switch will be replaced with a Maestro sensor switch.

- For models with a green-sleeved wire, (OPS5M, VPS5M, OPS6M2-DV, and VPS6M2-DV) when a neutral connection is available, remove the green sleeve and connect the white wire to neutral. Connect green-sleeved wire in retrofit and replacement applications where no neutral wire is present. Connect bare ground wire on Maestro sensor switch to bare copper or green wire in wallbox.
- For models with only a neutral (white) wire, (OPS6M2N-DV, VPS6M2N-DV). Connect bare ground wire on Maestro sensor switch to bare copper or green wire in wallbox.
- Connect white wire on Maestro sensor switch to white wire (neutral) in wallbox (OPS6M2N-DV, VPS6M2N-DV)
- Connect one of the remaining wires removed from switch to black wire on Maestro sensor switch.
- Connect remaining wire removed from switch to the other black wire on Maestro sensor switch.
- Blue wire is nowt used in a single-pole circuit. Cap blue wire.

**-OPS5M, -VPS5M, -OPS6M2-DV, and -VPS6M2-DV (with Neutral)**

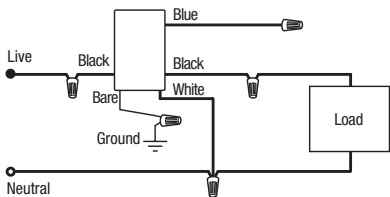
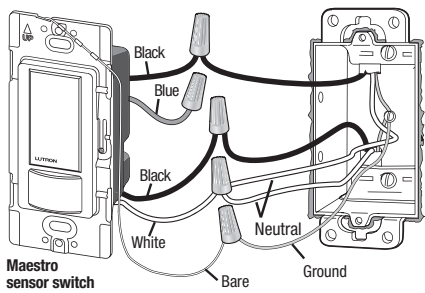

**-OPS5M, -VPS5M, -OPS6M2-DV, and -VPS6M2-DV (without Neutral)**

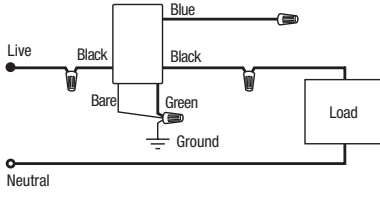
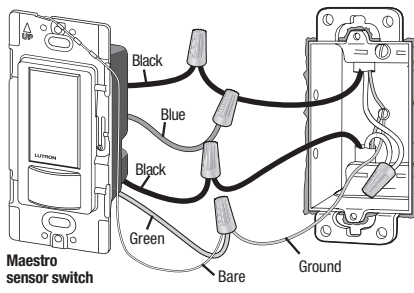

**-OPS6M2N-DV, and -VPS6M2N-DV**

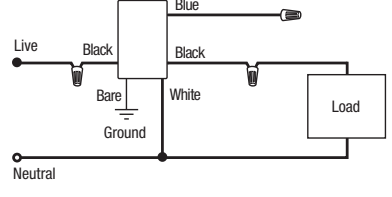
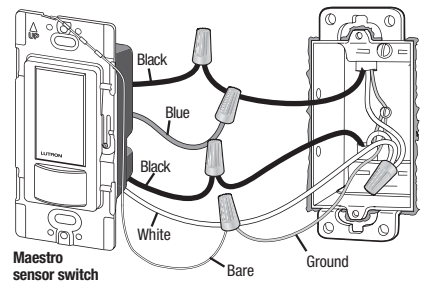

**5B 3-way (Two locations)**

**NOTE:** 120 V~ circuits use MA-AS/MS-C-AS Companion Switches  
 240/277 V~ circuits use MA-AS-277/MS-C-AS-277 Companion Switches

**Wire the Maestro sensor switch**

- For models with a green-sleeved wire, (OPS5M, VPS5M, OPS6M2-DV, and VPS6M2-DV) when a neutral connection is available, remove the green sleeve and connect the white wire to neutral. Connect green-sleeved wire to ground only in retrofit and replacement applications where no neutral wire is present. Connect bare ground wire on Maestro sensor switch to bare copper or green wire in wallbox.
- For models with a neutral (white) wire, (OPS6M2N-DV, VPS6M2N-DV). Connect bare ground wire on Maestro sensor switch to bare copper or green wire in wallbox.
- Connect white wire on Maestro sensor switch to white wire (neutral) in wallbox (OPS6M2N-DV, VPS6M2N-DV)
- Connect tagged wire removed from switch to one of the black wires on Maestro sensor switch.
- Connect one of the remaining wires removed from switch to the other black wire on Maestro sensor switch.
- Connect remaining wire removed from switch (note color) to blue wire on Maestro sensor switch.

**-OPS5M, -VPS5M, -OPS6M2-DV, and -VPS6M2-DV (with Neutral)**

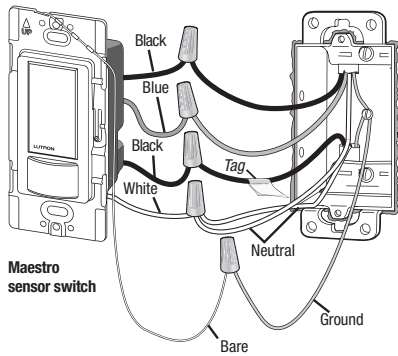

**-OPS5M, -VPS5M, -OPS6M2-DV, and -VPS6M2-DV (without Neutral)**

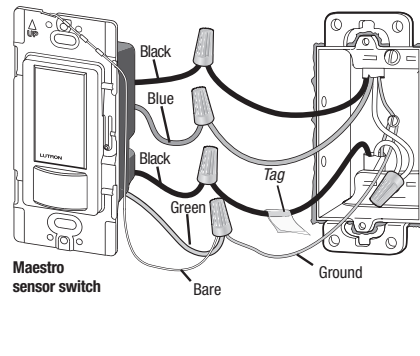

**-OPS6M2N-DV, and -VPS6M2N-DV**

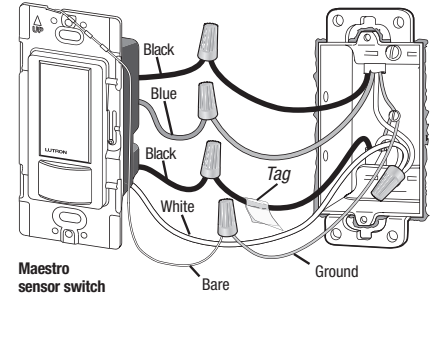

**Wire the companion switch**

- Connect green ground wire on companion switch to bare copper or green wire in wallbox.
- Connect tagged wire removed from switch to black screw terminal on companion switch.
- Connect the same color wire connected to the blue wire on Maestro sensor switch (color noted above) to the blue screw terminal on companion switch.
- Connect remaining wire removed from switch to brass screw terminal on companion switch.

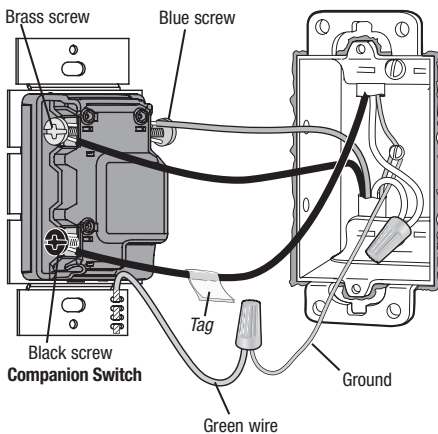

See wiring diagrams on next page.

**5B** Wiring Diagrams

<b>Product Key</b>	<b>Switch Type</b>	Companion switch	Maestro sensor switch (Wires)	
	<b>Screw Color (120 V~ Companion switch)</b>	Brass	Blue	Black
	<b>Wire Color (277 V~ Companion switch)</b>	Black Wire	Blue Wire	Black Wire

**-OPS5M, -VPS5M, -OPS6M2-DV, and -VPS6M2-DV (with Neutral)**

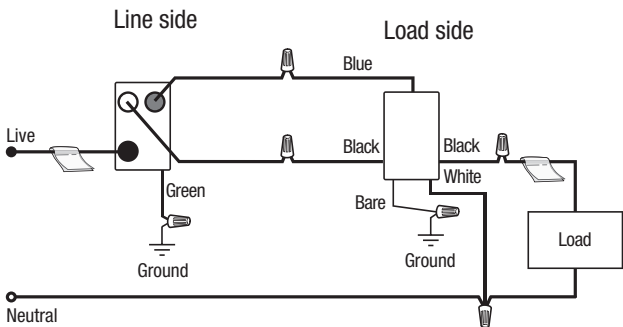
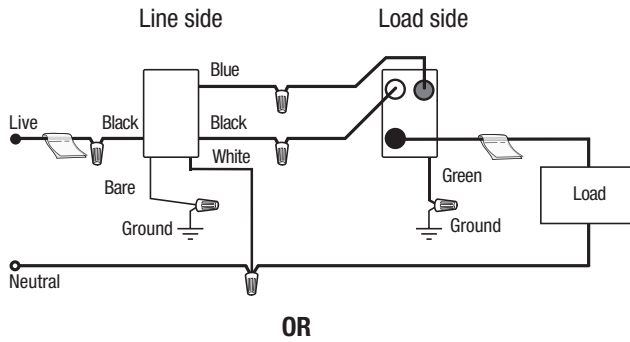

**-OPS5M, -VPS5M, -OPS6M2-DV, and -VPS6M2-DV (without Neutral)**

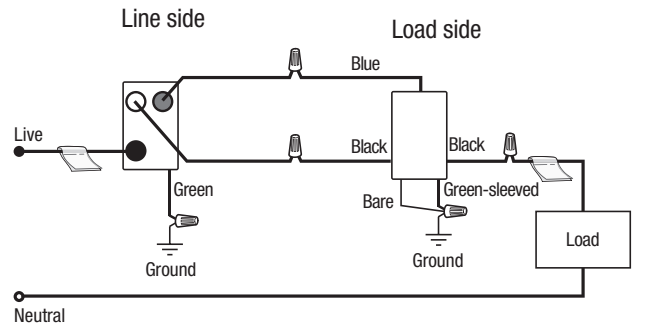
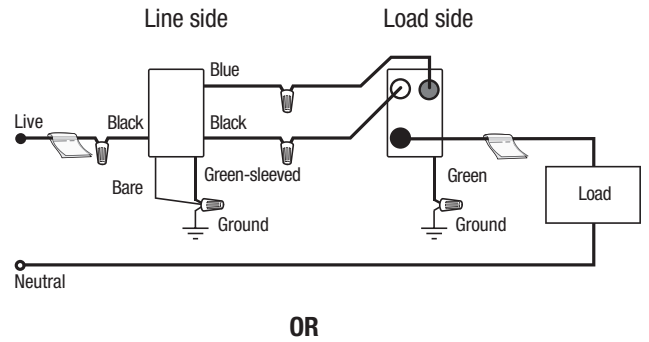

**-OPS6M2N-DV, and -VPS6M2N-DV**

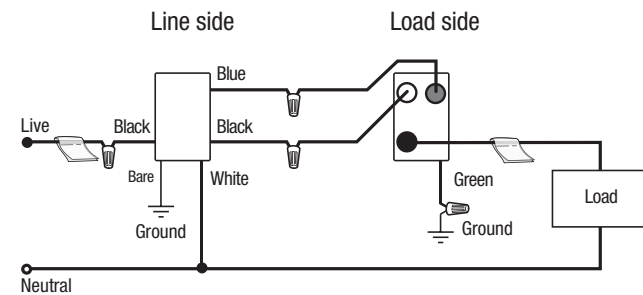

**OR**

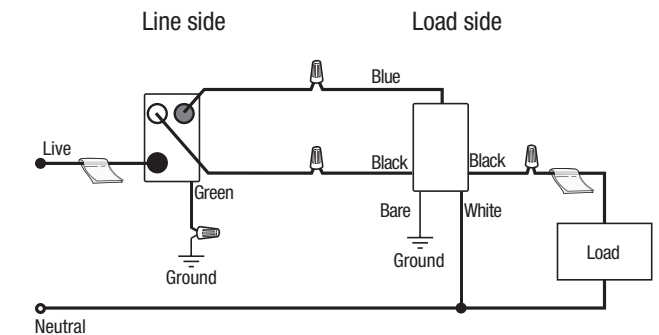

**NOTE:** Maximum wire length between the Maestro sensor switch and the companion switch (Total blue terminal wire length) is 150 ft (46 m).

**5c 4-way (Three or more locations)**

**NOTE:** The Maestro sensor switch can be installed in any of the locations (choose the location where the sensor will have optimal coverage of the space). The occupancy sensing switch and/or companion switches can replace a 4-way switch or 3-way switch (4-way applications typically include both 4-way and 3-way switches).

**Wire the Maestro sensor switch replacing a 4-way switch**

- For models with a green-sleeved wire, (OPS5M, VPS5M, OPS6M2-DV, and VPS6M2-DV) when a neutral connection is available, remove the green sleeve and connect the white wire to neutral. Connect green-sleeved wire to ground only in retrofit and replacement applications where no neutral wire is present. Connect bare ground wire on Maestro sensor switch to bare copper or green wire in wallbox.
- For models with only a neutral (white) wire, (OPS6M2N-DV, VPS6M2N-DV) connect bare ground wire on Maestro sensor switch to bare copper or green wire in wallbox.
- Connect white wire on Maestro sensor switch to white wire (neutral) in wallbox (OPS6M2N-DV, VPS6M2N-DV)
- Connect both tagged wires (note color) removed from 4-way switch to blue wire on Maestro sensor switch.
- Connect one of the remaining wires removed from switch to one of the black wires on Maestro sensor switch.
- Connect remaining wire removed from switch to other black wire on Maestro sensor switch.

**-OPS5M, -VPS5M, -OPS6M2-DV, and -VPS6M2-DV (with Neutral)**

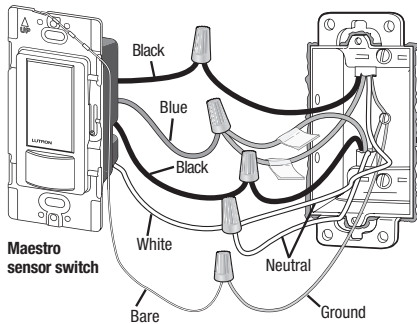

**-OPS5M, -VPS5M, -OPS6M2-DV, and -VPS6M2-DV (without Neutral)**

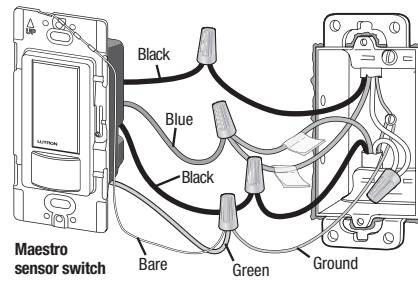

**-OPS6M2N-DV, and -VPS6M2N-DV**

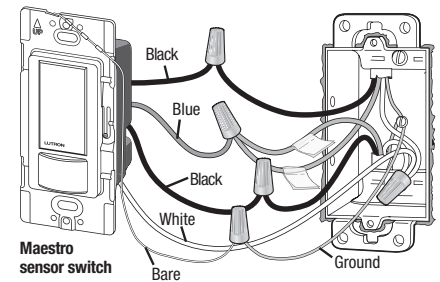

**Wire the companion switch replacing a 4-way switch**

- Connect green wire on companion switch to bare copper or green wire in wallbox.
- Connect both tagged wires (note wire color) removed from 4-way switch to blue screw terminal on companion switch (one wire to screw terminal the other to push-in terminal).
- Connect one of the remaining wires removed from switch to black screw terminal on companion switch.
- Connect remaining wire removed from switch to brass screw terminal on companion switch.

**NOTE:** Repeat for each companion switch replacing a 4-way switch.

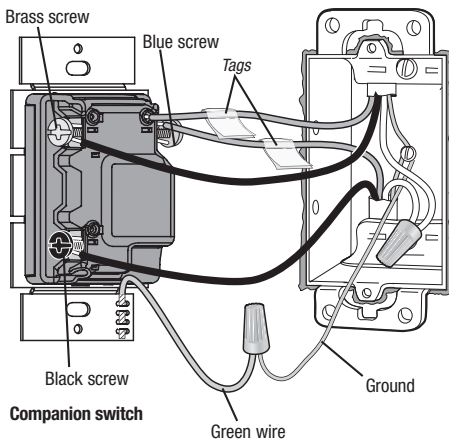

See wiring diagrams on page 7.

**5c** 4-way (Three or more location control)

**Wire the Maestro sensor switch replacing a 3-way switch**

- For models with a green-sleeved wire, (OPS5M, VPS5M, OPS6M2-DV, and VPS6M2-DV). When a neutral connection is available, remove the green sleeve and connect the white wire to neutral. Connect green-sleeved wire to ground only in retrofit and replacement applications where no neutral wire is present. Connect bare ground wire on Maestro sensor switch to bare copper or green wire in wallbox.
- For models with only a neutral (white) wire, (OPS6M2N-DV, VPS6M2N-DV) connect bare ground wire on Maestro sensor switch to bare copper or green wire in wallbox.
- Connect white wire on Maestro sensor switch to white wire (neutral) in wallbox (OPS6M2N-DV, VPS6M2N-DV)
- Connect tagged wire removed from switch to one of the black wires on Maestro sensor switch.
- Connect same color wire connected to blue screw terminal on companion switch that replaced 4-way switch (color noted above) to blue wire on Maestro sensor switch.
- Connect remaining wire removed from switch to the other Black wire on Maestro sensor switch.

**-OPS5M, -VPS5M, -OPS6M2-DV, and -VPS6M2-DV (with Neutral)**

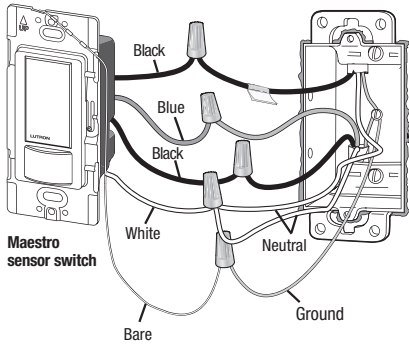

**-OPS5M, -VPS5M, -OPS6M2-DV, and -VPS6M2-DV (without Neutral)**

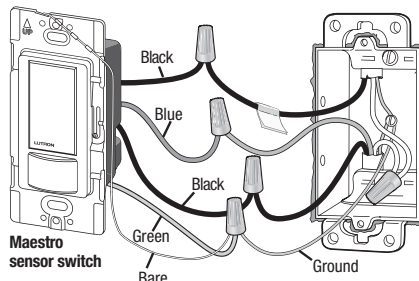

**-OPS6M2N-DV, and -VPS6M2N-DV**

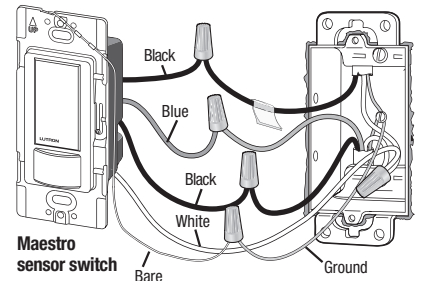

**Wire the companion switch(es) replacing a 3-way switch**

- Connect green ground wire on companion switch to bare copper or green wire in wallbox.
- Connect tagged wire removed from switch to the black screw terminal on companion switch.
- Connect same color wire connected to blue wire on Maestro sensor switch that replaced 4-way switch (color noted above) to blue screw terminal on companion switch.
- Connect remaining wire removed from switch to the brass screw terminal on companion switch. (See *Instructions that came with companion switch for more information*)

**NOTE:** Repeat for each companion switch replacing a 3-way switch.

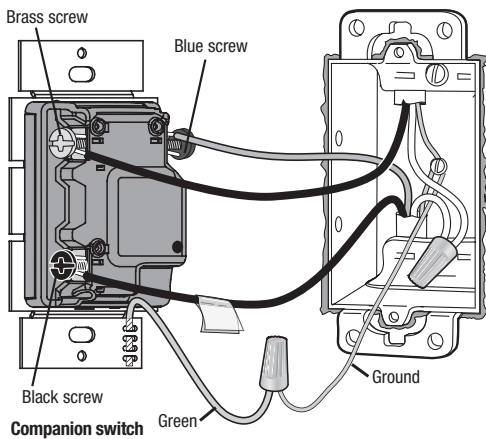

See wiring diagrams on next page.

5c Wiring Diagrams

<b>Product Key</b>	<b>Switch Type</b>	Companion switch	Maestro sensor switch (Wires)
	<b>Screw Color (120 V~ Companion switch)</b>	Brass	Blue
	<b>Wire Color (277 V~ Companion switch)</b>	Black Wire	Blue Wire

-OPS5M, -VPS5M, -OPS6M2-DV, and -VPS6M2-DV (with Neutral)

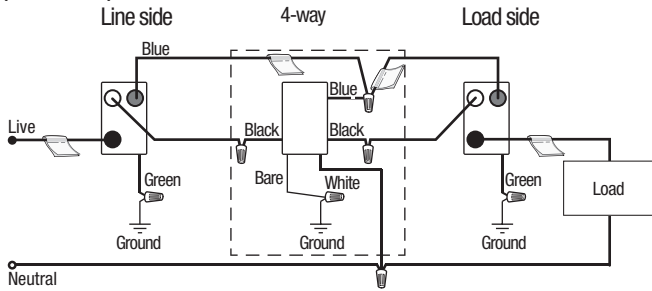

OR

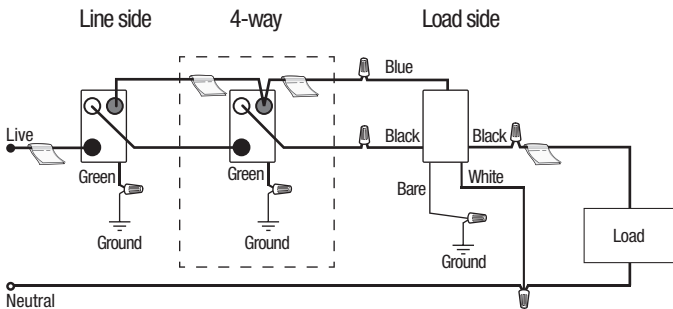

OR

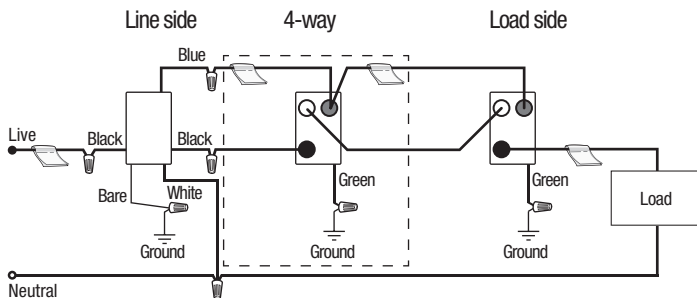

-OPS5M, -VPS5M, -OPS6M2-DV, and -VPS6M2-DV (without Neutral)

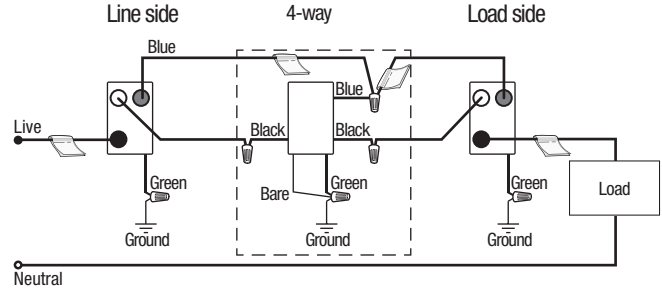

OR

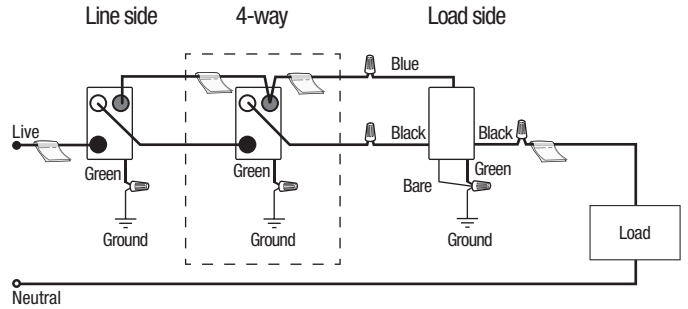

OR

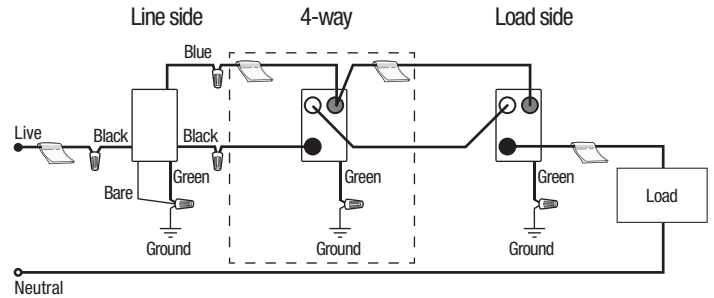

**NOTE:** Maximum wire length between the Maestro sensor switch and the companion switch (total blue terminal wire length) is 150 ft (46 m).

Wiring Diagrams (continued)

<b>Product Key</b>	<b>Switch Type</b>	Companion switch	Maestro sensor switch (Wires)
	<b>Screw Color (120 V~ Companion switch)</b>	Brass	Blue
	<b>Wire Color (277 V~ Companion switch)</b>	Black Wire	Blue Wire

-OPS6M2N-DV, and -VPS6M2N-DV

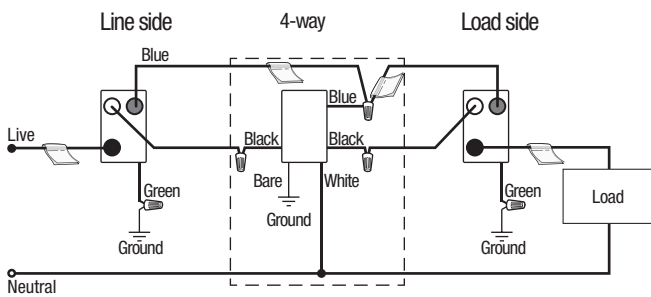

OR

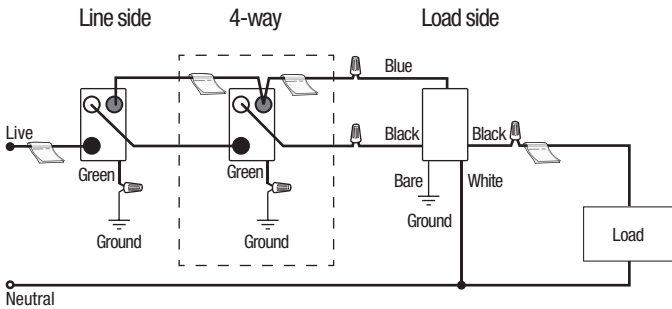

OR

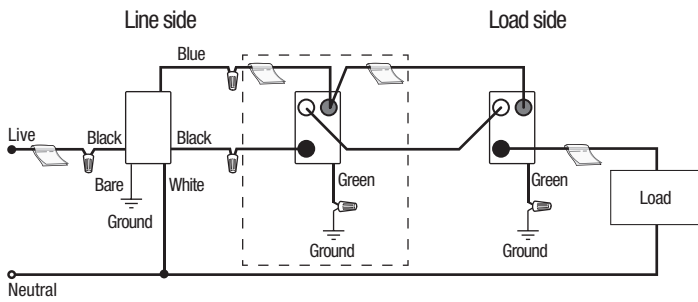

**NOTE:** Maximum wire length between the Maestro sensor switch and the companion switch (total blue terminal wire length) is 150 ft (46 m).



- 6** Push wires carefully into wallbox and install Maestro sensor switch and all companion switches. Leave wall plate off if custom settings are desired. See Maestro sensor switch installation instructions for details on custom settings.

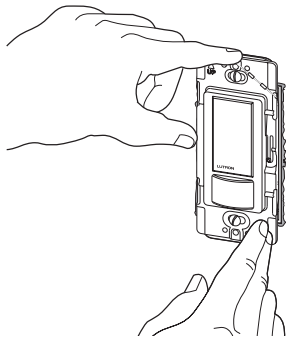

- 7** Turn power On at circuit breaker.

**NOTE:** Once power has been restored, the Maestro sensor switch can be manually turned on or off after 30 seconds but will not automatically control the load for the first 2 minutes.

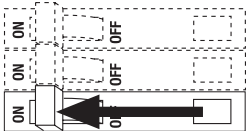

Lutron and Maestro are trademarks or registered trademarks of Lutron Electronics Co., Inc. in the US and/or other countries

## Lutron Contact Numbers

**WORLD HEADQUARTERS  
USA**  
Lutron Electronics Co., Inc.  
7200 Suter Road  
Coopersburg, PA 18036-1299  
TEL: +1.610.282.3800  
FAX: +1.610.282.1243  
support@lutron.com  
www.lutron.com/support

**North & South America  
Customer Assistance**  
**USA, Canada, Caribbean:**  
1.844.LUTRON1 (1.844.588.7661)  
**Mexico:**  
+1.888.235.2910  
**Central/South America:**  
+1.610.282.6701

**UK AND EUROPE:**  
Lutron EA Limited  
125 Finsbury Pavement  
4th floor, London EC2A 1NQ  
United Kingdom  
TEL: +44.(0)20.7702.0657  
FAX: +44.(0)20.7480.6899  
FREEPHONE (UK): 0800.282.107  
Technical Support: +44.(0)20.7680.4481  
lutronlondon@lutron.com

**ASIA:**  
Lutron GL Ltd.  
390 Havelock Road  
#07-04 King's Centre  
Singapore 169662  
TEL: +65.6220.4666  
FAX: +65.6220.4333  
Technical Support: 800.120.4491  
lutronsea@lutron.com

**Asia Technical Hotlines**  
Northern China: 10.800.712.1536  
Southern China: 10.800.120.1536  
Hong Kong: 800.901.849  
Indonesia: 001.803.011.3994  
Japan: +81.3.5575.8411  
Macau: 0800.401  
Taiwan: 00.801.137.737  
Thailand: 001.800.120.665853  
Other Countries: +65.6220.4666