

Step 3: Hang television on to the Wall Plate

a. Carefully lift the television and place arm hooks over and onto top rail of Wall Plate (Figure 5). Let bottom angle downward and toward wall. The Safety Clips on the arms will click as they pass under the bottom lip of the wall plate.

b. To remove, first pull downward on Release String to lower Safety Clips and then pull TV out and up off the Wall Plate.

Note: Failure to do so may damage the Safety Clips.

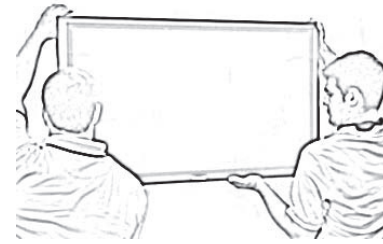

Figure 5

ADJUSTMENTS:

Tilt Adjustment

a. A maximum of 12° forward tilt can be achieved (Figure 6). To increase tilt, hold the TV at the top and pull away from the wall carefully to desired position. To reduce tilt, hold the TV at the top and push back toward the wall. No locking is required.

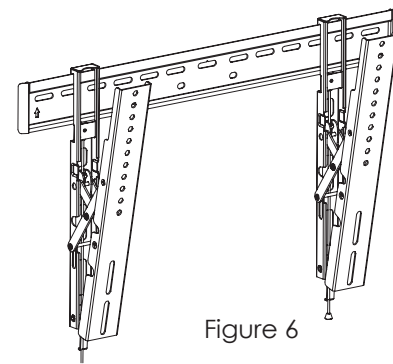

Figure 6

Kickstand

a. Installed in the bottom of the arms are Kickstands that allow the bottom of TV to be temporarily positioned away from the wall, hands free, to locate and plug-in cables and power cord (Figure 7).

Note: You must first pull downward on Release String to lower Safety Clips on both arms to pull bottom away from the wall. Failure to do so may damage the Safety Clips.

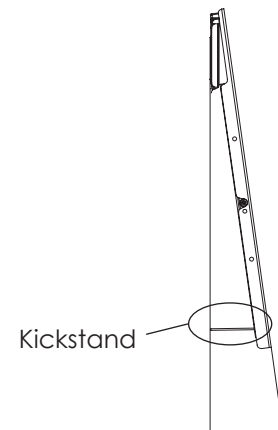

Figure 7



Lifetime Limited Warranty

Strong™ Mounts have a Lifetime Limited Warranty. This warranty includes parts and labor repairs on all components found to be defective in material or workmanship under normal conditions of use. This warranty shall not apply to products which have been abused, modified or disassembled. Products to be repaired under this warranty must be returned to SnapAV or a designated service center with prior notification and an assigned return authorization number (RA).

For Technical Support call 1.866.838.5052

SM-THIN-T-M / SM-THIN-T-L

Strong™ Low Profile Tilt Mount for Ultra-Thin Flat-Panel TV's (Black)



engineered by
Snap
av

INSTRUCTION MANUAL

WARNINGS:

- Installation by a qualified professional is highly recommended for this product.
- Do not begin installation until you have thoroughly read and understand these instructions.
- Medium mount supports displays from 26-47", VESA 100X100, up to 600X400, and a maximum load of 100 lbs. Large mount supports displays from 37-63", VESA 200X200; 300X300 up to 800X500, and a maximum load of 100 lbs.
- Ensure the mounting wall will safely support four times the combined weight of the Mount and display panel.
- Under no circumstances should this product be mounted to metal studs.
- The manufacturer does not accept responsibility for incorrect installation.
- Due to low profile, check with the TV manufacturer to ensure the particular display being used can be installed 1" from the wall.

SPECIFICATIONS:

- Maximum Load: 100 lbs. (45 kg)
- Display Size
 - Medium (SM-THIN-M): 26-47"
 - Large (SM-THIN-L): 37-63"

BOX CONTENTS:

- Wall Plate (1)
- Arm left (1)
- Arm right (1)
- Hardware Pack (1)

PACKAGE CONTENTS:

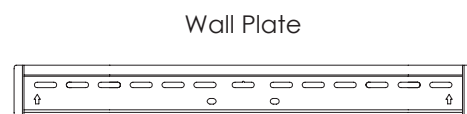

Arms

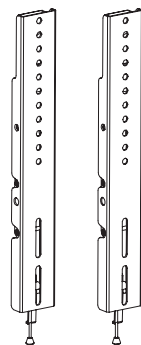

(P) M2.5X55mm Allen Key

TOOLS REQUIRED:

- Power Drill
- 5/16" and 1/4" Drill Bit
- Level
- Stud Finder



CAUTION:

These wall mounts are intended for use only with the maximum weight of :
 SM-THIN-M: 100 lbs (45kg)
 SM-THIN-L: 100 lbs (45kg)

HARDWARE KIT

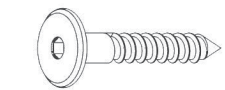

(A) M6x50 Lag Screws (x4)

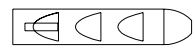

(B) Concrete Anchors (x4)

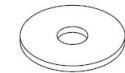

(C) Washers (x4)

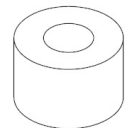

(D) 1/4" ABS Spacer (x4)

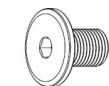

(E) M4X12 (x4)

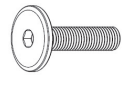

(F) M4X25 (x4)

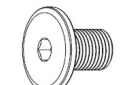

(G) M5X12 (x4)

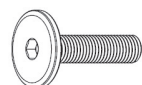

(H) M5X25 (x4)

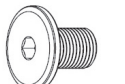

(I) M6X12 (x4)

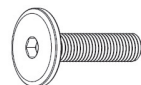

(J) M6X25 (x4)

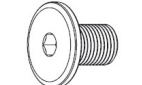

(K) M8X12 (x4)

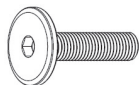

(L) M8X25 (x4)

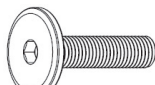

(M) M8X30 (x4)

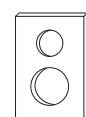

(N) 25mmx25mm Diameter Washer(x4)



(O) M4 Allen Key Drill Bit (x1)



(P) M2.5X55mm Allen Key



(Q) M4X100mm Allen Key



(R) M5X100mm Allen Key

INSTALLATION:

Step 1: Mounting the Wall Bracket Assembly

For Mounting on a Stud Wall

- Pre-drill holes into two wood studs using a 1/4" drill bit. Be sure to drill into the center of the studs at least 2-1/2" deep. The use of a stud finder is highly recommended.
- Insert two Lag Screws (A) through Washers (C) into holes through the Wall Plate and tighten down using Allen Key Drill Bit (O).

WARNING: Tighten bolts so that wall plate is firmly attached, but do not overtighten. Overtightening can damage the bolts, greatly reducing their holding strength.

For Mounting on a Concrete Wall

- Pre-drill holes into concrete using 5/16" drill bits to a depth of 2-1/2". Insert concrete wall anchors (B) and tap in-with hammer, if necessary (Figures 2 & 3).

WARNING: When installing wall arm assembly on cinder block, verify first that you have a minimum of 1-3/8" of concrete thickness to be used for the concrete anchors. Do not drill into mortar joints! Be sure to mount in a solid part of the block, generally 1" minimum from the side of the block. Cinder block must meet ASTM C-90 specifications. It is suggested that a standard electric drill on slow setting is used to drill the hole instead of a hammer drill to avoid breaking out the back of the hole when entering a void or cavity.

Concrete must be 2000 psi density minimum. Lighter density concrete may not hold concrete anchor.

Make sure that the supporting surface will safely support the combined load of the equipment and all attached hardware and components.

- Insert four Lag screws (A) through Washers (C) into the wall anchors through the Wall Plate. Tighten all bolts using Allen Key Drill Bit (O).

WARNING: Tighten bolts so the wall plate is firmly attached, but do not overtighten. Overtightening can damage the bolts, greatly reducing their holding strength.

Step 2: Mount arms to television

- Determine the diameter of the screw (parts E through M) your TV requires by carefully trying to hand-thread one into the threaded insert on the rear of the TV. If there is any resistance, stop immediately.
- Spacers(D) are commonly needed on televisions with curved backs or recessed screw inserts. The screw will thread through the appropriate washer (N), spacers, and the arms into the TV.
- Ensure the arms are installed flat side to television, and are square to each other after all screws have been installed (Figure 4).

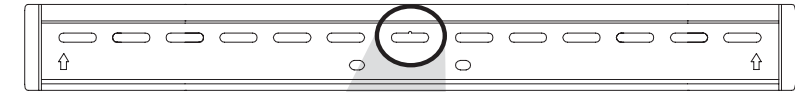
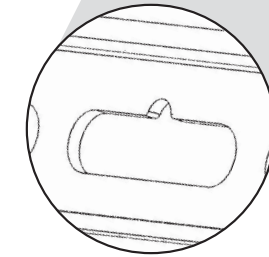

Figure 1



TIP: To assist in installation, the wall bracket features a screw slot for temporary hanging of the bracket.

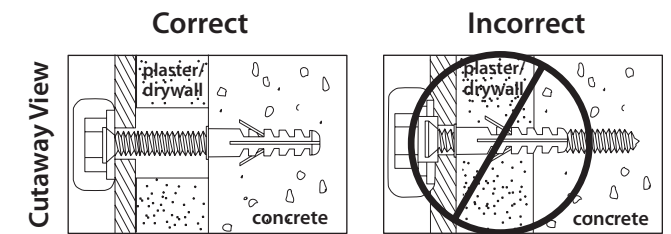

Figure 2

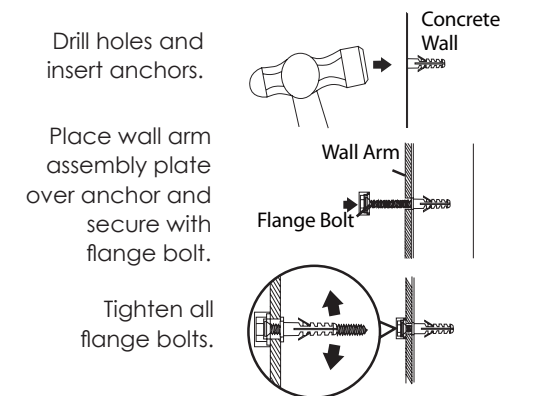

Figure 3

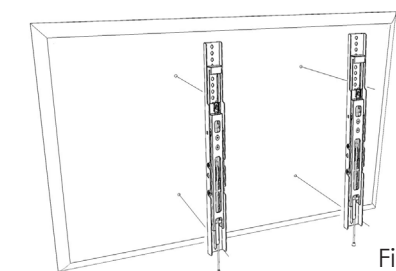

Figure 4